

Project No.: 660175 1B 19900



Construction Documents for Lazy K Restoration

VOLUME 1

University of California Merced
Merced County
Merced, California

**Design & Construction
University of California
5200 N. Lake Road
Merced, California 95343**

June 24, 2015

CERTIFICATION

Name of Project: LAZY K RESTORATION

Bidding Documents Prepared by: Vollmar Natural Lands Consulting

1720 Solano Ave
Berkeley, CA 94707
(510) 559-9603 Fax (510) 559-9605
www.vollmarconsulting.com

Signed:

(Signature of an Officer of the Firm Named Above)

Date

--	--

**CONSTRUCTION DOCUMENTS
TABLE OF CONTENTS**

Volume 1

Cover Page
Certification
Construction Documents Table of Contents
Advertisement for Bids
Project Directory
Instructions to Bidders
Supplementary Instructions to Bidders
Information Available to Bidders
Bid Form
Bid Bond
Contractor Master Project Schedule
Agreement
General Conditions
Supplementary General Conditions
Exhibit Table of Contents
Exhibits
Division 1 Specifications
Technical Narrative(s)
Drawing(s) (Under Separate Cover)

Division 1 Specifications

Section	01 11 00	Summary of Work
	01 11 10.10	Natural Resources Avoidance & Minimization Measures
	01 21 00	Allowances
	01 22 00	Unit Prices
	01 23 00	Alternates – NOT USED
	01 25 00	Product Options and Substitutions
	01 26 13	Requests For Information
	01 31 00	Project Coordination
	01 31 19	Project Meetings
	01 31 42	Contractor Schedules
	01 31 45	Contract Schedules
	01 33 23	Shop Drawings, Product Data and Samples
	01 35 00	Special Requirements
	01 35 40	Environmental Mitigation
	01 35 43	Hazardous Materials Procedures
	01 41 00	Regulatory Requirements
	01 42 13	Abbreviation, Symbols, & Definitions
	01 43 39	Mockups – NOT USED
	01 43 40	Exterior Enclosure Performance Requirements – NOT USED
	01 45 00	Quality Control
	01 51 00	Temporary Utilities
	01 56 00	Temporary Barriers and Enclosures
	01 56 39	Tree and Plant Protection – NOT USED

- 01 57 23 Storm Water Pollution Prevention
- 01 60 00 Product Requirements
- 01 71 23 Field Engineering
- 01 73 23 Supporting from Building Structure – NOT USED
- 01 73 29 Cutting, Patching, and Matching – NOT USED
- 01 73 35 Selective Demolition
- 01 74 19 Site Waste Management Program – NOT USED
- 01 77 00 Closeout Procedures, Final Cleaning, and Extra Materials
- 01 78 36 Guarantees, Warranties, Bonds, Service & Maintenance Contracts
- 01 78 39 Project As-Built Documents
- 01 79 00 Training – NOT USED
- 01 81 13 LEED™ Requirements – NOT USED
- 01 81 13.1 LEED Requirements Score Card – NOT USED
- 01 91 00 Commissioning – NOT USED
- 01 92 00 Operating and Maintenance – NOT USED

List of Technical Narrative(s)

Number	Title	Last Modified
1	Lazy K Final Vernal Pool Restoration Design & Construction Plan	5/8/2015
2	Lazy K Restoration & Re-vegetation Plan	5/18/2015

List of Drawing(s)

Sheet Number	Title	Last Modified
1	Lazy K Grading Plan	5/15/2015
2	Potential Sediment Control Requirement Map - SWPPP Erosion Control Plan	6/15/2015
3	LZYK-01 – Water Trough & Fence Location	6/15/2015
4	SWPPP BMP's	6/15/15

ADVERTISEMENT FOR BIDS
LAZY K RESTORATION
PROJECT NO.: 661075 1B 19900
UNIVERSITY OF CALIFORNIA, MERCED

DESCRIPTION OF PROJECT:

Perform excavation of small mammal burrows in designated areas as directed by Designated Biologist and to perform grading work to develop vernal pools per the Contract Documents.

Bidding Documents will be made available to **General Contractors** on **Thursday, June 25, 2015**. One complete set of bidding documents will be available free of charge. Contact BrightDart at www.ucmercedplanroom.com to order plans or call them at (209) 385-3800. Additional sets may be purchased at cost.

Project Budget \$650,000.00

Contractor License: A

A NON-MANDATORY Project Site Visit will be conducted on July 1, 2015, beginning promptly at 9:00 AM. Participants shall meet at Lazy K Ranch, 8314 S. Santa Fe Ave., Chowchilla CA.

If you need accommodations related to disabilities, please call Fran Telechea (209) 228-4479 at least 3 working days prior to Pre-Bid Conference/Project Site Visit or Bid Opening.

Requests for clarification or interpretation of the Bidding Documents must be in writing and received by **Tuesday, July 7, 2015 at 4:00 P.M.** Questions received after the above-noted deadline may be answered at the discretion of the University's Representative. Questions may be emailed to:

Fran Telechea – University of California, Merced
Email: ftelechea@ucmerced.edu

Revisions, additions or deletions will be made by written addenda issued by Design & Construction.

Bids will be received only at:
(Hand & Overnight delivery only)

UNIVERSITY OF CALIFORNIA, MERCED
Design and Construction
767 E Yosemite Ave., Bldg. B, Ste C
Merced CA 95340

Or by US Mail at:

UNIVERSITY OF CALIFORNIA, MERCED
Design and Construction
5200 Lake Rd.
Merced CA 95343

Bids must be received before:

2:00:00 PM
July 14, 2015

Bid Results will be available on our website at <http://www.ucmerced.edu/community/rfprfq.asp> or by calling (209) 228-4479.

There will be bid security required for this project.

The successful Bidder and its Subcontractors will be required to follow the nondiscrimination requirements set forth in the Bidding Documents and to pay prevailing wage rates at the location of the Work.

At the time of submission of the bid, Bidder and all subcontractors, regardless of tier, shall have the appropriate current licenses issued by the State of California Contractors State License Board for the work to be performed.

THE UNIVERSITY OF CALIFORNIA IS AN AFFIRMATIVE ACTION/EQUAL OPPORTUNITY EMPLOYER.

PROJECT DIRECTORY

Project Name: LAZY K RESTORATION
Project No: 661075 1B 19900
Location: Design & Construction
University of California
Merced Campus
University: The Regents of the University of California
University's Facility person
acting on behalf of University: Michael Chow
Associate Vice Chancellor Design & Construction
University's Representative is: Fran Telechea
Design & Construction
5200 North Lake Road
Merced CA 95343
(209) 228-4479 Fax (209) 228-4468
All inquiries shall be in writing and shall be
directed only to: Fran Telechea
Design & Construction
5200 North Lake Road
Merced CA 95343
(209) 228-4479
ftelechea@ucmerced.edu
Design Professional Consultants: Vollmar Natural Lands Consulting
1720 Solano Ave
Berkeley, CA 94707
(510) 559-9603 Fax (510) 559-9605
www.vollmarconsulting.com
Address for Stop Notices: Marianna Eastman
University of California
5200 North Lake Road
Merced CA 95343
and
Design & Construction
University of California
5200 North Lake Road
Merced CA 95343
Address for Demand for Arbitration: Western Case Management Center
6795 N. Palm Avenue, 2nd Floor
Fresno CA 93704
A copy of the Demand for Arbitration must be
sent to: University of California
Office of the General Counsel
1111 Franklin Street, 8th Floor
Oakland, CA 94607-5200

INSTRUCTIONS TO BIDDERS

TABLE OF CONTENTS

ARTICLE 1 - DEFINITIONS

ARTICLE 2 - BIDDER'S REPRESENTATIONS

ARTICLE 3 - BIDDING DOCUMENTS

- 3.1 COPIES
- 3.2 INTERPRETATION OR CORRECTION OF BIDDING DOCUMENTS
- 3.3 PRODUCT SUBSTITUTIONS
- 3.4 SUBCONTRACTORS
- 3.5 ADDENDA
- 3.6 BUILDER'S RISK PROPERTY INSURANCE

ARTICLE 4 - PRE-BID CONFERENCE

ARTICLE 5 - BIDDING PROCEDURES

- 5.1 FORM AND STYLE OF BIDS
- 5.2 BID SECURITY
- 5.3 SUBMISSION OF BIDS
- 5.4 MODIFICATION OR WITHDRAWAL OF BID

ARTICLE 6 - CONSIDERATION OF BIDS

- 6.1 OPENING OF BIDS
- 6.2 REJECTION OF BIDS
- 6.3 AWARD

ARTICLE 7 - BID PROTEST

- 7.1 FILING A BID PROTEST
- 7.2 RESOLUTION OF BID CONTROVERSY

ARTICLE 1

DEFINITIONS

1.1 Except as otherwise specifically provided, definitions set forth in the General Conditions or in other Contract Documents are applicable to all Bidding Documents.

1.2 The term “Addenda” means written or graphic instruments issued by University prior to the Bid Deadline which modify or interpret the Bidding Documents by additions, deletions, clarifications, or corrections.

1.3 The term “Alternate” means a proposed change in the Work, as described in the Bidding Documents which, if accepted, may result in a change to either the Contract Sum or the Contract Time, or both.

1.4 The term “Bid Deadline” means the date and time on or before which Bids must be received, as designated in the Advertisement for Bids and which may be revised by Addenda.

1.5 The term “Bidder” means a person or firm that submits a Bid.

1.6 The term “Bidding Documents” means the construction documents prepared and issued for bidding purposes including all Addenda thereto.

1.7 The term “Estimated Quantity” means the estimated quantity of an item of Unit Price Work.

1.8 As used in these Instructions to Bidders, the term “Facility” means the University's Facility office issuing the Bidding Documents.

1.9 The term “Lump Sum Base Bid” means the sum stated in the Bid for which Bidder offers to perform the Work described in the Bidding Documents, but not including Unit Price items or Alternates.

1.10 The term “Planholder” means a person or entity known by the Facility to have received a complete set of Bidding Documents and who has provided a street address for receipt of any written pre-bid communications.

1.11 The term “Unit Price” means an amount stated in the Bid for which Bidder offers to perform an item of Unit Price Work for a fixed price per unit of measurement.

1.12 As used in these Instructions to Bidders, the term “Business Day” means any day other than a Saturday, a Sunday, and the holidays specified herein, and to the extent provided herein, if the Facility or applicable office of the University is closed for the whole of any day, insofar as the business of that office is concerned, that day shall be considered as a holiday for the purposes of computing time in these Instructions to Bidders. Holidays include January 1st, the third Monday in January, the third Monday in February, the last Monday in May, July 4th, the first Monday in September, November 11th, Thanksgiving Day, December 25th, and every day designated by the University as a holiday.

ARTICLE 2

BIDDER'S REPRESENTATIONS

2.1 Bidder, by making a Bid, represents that:

2.1.1 Bidder has read, understood, and made the Bid in accordance with the provisions of the Bidding Documents.

2.1.2 Bidder has visited the Project site and is familiar with the conditions under which the Work is to be performed and the local conditions as related to the requirements of the Contract Documents.

2.1.3 The Bid is based upon the materials, equipment, and systems required by the Bidding Documents without exception.

2.1.4 At the time of submission of the Bid, Bidder and all Subcontractors, regardless of tier, have the appropriate current and active licenses issued by the State of California Contractors State License Board for the Work to be performed and any licenses specifically required by the Bidding Documents. If Bidder is a joint venture, at the time of submission of the Bid, Bidder shall have the licenses required by the preceding sentence in the name of the joint venture itself. The State of California Business and Professions Code, Division 3, Chapter 9, known as the "Contractor's License Law," establishes licensing requirements for contractors.

2.1.5 Bidder has read and shall abide by the nondiscrimination requirements contained in the Bidding Documents.

2.1.6 Bidder has the expertise and financial capacity to perform and complete all obligations under the Bidding Documents.

2.1.7 The person executing the Bid Form is duly authorized and empowered to execute the Bid Form on behalf of Bidder.

2.1.8 Bidder is aware of and, if awarded the Contract, will comply with Applicable Code Requirements in its performance of the Work.

ARTICLE 3

BIDDING DOCUMENTS

3.1 COPIES

3.1.1 Bidders may obtain complete sets of the Bidding Documents from the issuing office designated in the Advertisement for Bids for the sum stated therein, if any. Documents are only available in full sets and shall not be returned.

3.1.2 Bidders shall use a complete set of Bidding Documents in preparing Bids.

3.1.3 University makes copies of the Bidding Documents available, on the above terms, for the sole purpose of obtaining Bids for the Work and does not confer a license or grant permission for any other use of the Bidding Documents.

3.2 INTERPRETATION OR CORRECTION OF BIDDING DOCUMENTS

3.2.1 Bidder shall, before submitting its Bid, carefully study and compare the components of the Bidding Documents and compare them with any other work being bid concurrently or presently under construction which relates to the Work for which the Bid is submitted; shall examine the Project site, the conditions under which the Work is to be performed, and the local conditions; and shall at once report to University's Representative errors, inconsistencies, or ambiguities discovered. If Bidder is awarded the Contract, Bidder waives any claim arising from any errors, inconsistencies or ambiguities, that Bidder, its subcontractors or suppliers, or any person or entity under Bidder on the Contract became aware of, or reasonably should have become aware of, prior to Bidder's submission of its Bid.

3.2.2 Requests for clarification or interpretation of the Bidding Documents shall be addressed only to the person or firm designated in the Supplementary Instructions to Bidders.

3.2.3 Clarifications, interpretations, corrections, and changes to the Bidding Documents will be made by Addenda issued as provided in Article 3.5. Clarifications, interpretations, corrections, and changes to the Bidding Documents made in any other manner shall not be binding and Bidders shall not rely upon them.

3.3 PRODUCT SUBSTITUTIONS

3.3.1 No substitutions will be considered prior to award of Contract. Substitutions will only be considered after award of the Contract and as provided for in the Contract Documents.

3.4 SUBCONTRACTORS

3.4.1 Each Bidder shall list in the Bid Form all first-tier Subcontractors that will perform work, labor or render such services as defined in Article 9 of the Bid Form. The Bid Form contains spaces for the following information when listing Subcontractors: (1) portion of the Work; (2) name of Subcontractor; (3) city of Subcontractor's business location; (4) California contractor license number. An inadvertent error in listing the California contractor license number shall not be grounds for filing a bid protest or grounds for considering the bid nonresponsive if the corrected contractor's license number is submitted in

writing by, and actually received from, the Bidder within 24 hours after the bid opening and provided the corrected contractor's license number corresponds to the submitted name and location for that subcontractor. The failure to list, on the Bid Form, any one of the items set forth above will result in the University treating the Bid as if no Subcontractor was listed for that portion of the Work and Bidder will thereby represent to University that Bidder agrees that it is fully qualified to perform that portion of the Work and shall perform that portion of the Work.

3.4.2 Subcontractors listed in the Bid Form shall only be substituted after the Bid Deadline with the written consent of University and in accordance with the State of California "Subletting and Subcontracting Fair Practices Act."

3.5 ADDENDA

3.5.1 Addenda will be issued only by University and only in writing. Addenda will be identified as such and will be mailed or delivered to all Planholders. At its sole discretion, the University may elect to deliver Addenda via facsimile to Planholders who have provided a facsimile number for receipt of Addenda.

3.5.2 Copies of Addenda will be made available for inspection wherever Bidding Documents are on file for inspection.

3.5.3 Addenda will be issued such that Planholders should receive them no later than 3 full business days prior to the Bid Deadline. Addenda withdrawing the request for Bids or postponing the Bid Deadline may be issued anytime prior to the Bid Deadline.

3.5.4 Each Bidder shall be responsible for ascertaining, prior to submitting a Bid, that it has received all issued Addenda.

3.6 BUILDER'S RISK PROPERTY INSURANCE

3.6.1 University will provide builder's risk property insurance subject to the deductibles in the policy as required by the General Conditions if the Contract Sum exceeds \$200,000 at the time of award and the requirements of the Project are not excluded by such coverage. A summary of the provisions of the policy is included as an Exhibit to the Contract; the policy may be reviewed at the Facility office. Bidder agrees that the University's provision of builder's risk property insurance containing said provisions meets the University's obligation to provide builder's risk property insurance under the Contract and, in the event of a conflict between the provisions of the policy and any summary or description of the provisions contained herein or otherwise, the provisions of the policy shall control and shall be conclusively presumed to fulfill the University's obligation to provide such insurance.

ARTICLE 4

PRE-BID CONFERENCE

4.1 Bidder shall attend the Pre-Bid Conference at which the requirements of the Bidding Documents are reviewed by University, comments and questions are received from Bidders, and a Project site visit is conducted. University requires all Pre-Bid Conference attendees to arrive for the meeting on time and to sign an attendance list, which in turn is used to determine if Bidders meet this requirement. Any Bidder not attending the Pre-Bid Conference in its entirety will be deemed to have not complied with the requirements of the Bidding Documents and its Bid will be rejected.

ARTICLE 5

BIDDING PROCEDURES

5.1 FORM AND STYLE OF BIDS

5.1.1 Bids shall be submitted on the Bid Form included with the Bidding Documents. Bids not submitted on the University's Bid Form shall be rejected.

5.1.2 The Bid Form shall be filled in legibly in ink or by typewriter. All portions of the Bid Form must be completed and the Bid Form must be signed before the Bid is submitted. Failure to comply with the requirements of this Article 5.1.2 will result in the Bid being rejected as nonresponsive.

5.1.3 Bidder's failure to submit a price for any Alternate or Unit Price will result in the Bid being considered as nonresponsive. If Alternates are called for and no change in the Lump Sum Base Bid is required, indicate "No Change" by marking the appropriate box.

5.1.4 Bidder shall make no stipulations on the Bid Form nor qualify the Bid in any manner.

5.1.5 The Bid Form shall be signed by a person or persons legally authorized to bind Bidder to a contract. Bidder's Representative shall sign and date the Declaration included in the Bid Form. Failure to sign and date the declaration will cause the Bid to be rejected.

5.2 BID SECURITY

5.2.1 Each Bid shall be accompanied by Bid Security in the amount of 10% of the Lump Sum Base Bid as security for Bidder's obligation to enter into a Contract with University on the terms stated in the Bid Form and to furnish all items required by the Bidding Documents. Bid Security shall be a Bid Bond on the form provided by University and included herein, or a certified check made payable to "The Regents of the University of California." When a Bid Bond is used for Bid Security, failure to use University's Bid Bond form will result in the rejection of the Bid. Bidder must use the Bid Bond form provided by the University or an exact, true and correct photocopy of such form. The Bid Bond form may

not be retyped, reformatted, transcribed onto another form, or altered in any manner except for the purpose of completing the form.

5.2.2 If the apparent lowest responsible Bidder fails to sign the Agreement and furnish all items required by the Bidding Documents within the time limits specified in these Instructions to Bidders, University may reject such Bidder's Bid and select the next apparent lowest responsible Bidder until all Bids have been exhausted or University may reject all Bids. The Bidder whose Bid is rejected for such failure(s) shall be liable for and forfeit to University the amount of the difference, not to exceed the amount of the Bid Security, between the amount of the Bid of the Bidder so rejected and the greater amount for which University procures the Work.

5.2.3 If a Bid Bond is submitted, the signature of the person executing the Bid Bond must be notarized. If an attorney-in-fact executes the Bid Bond on behalf of the surety, a copy of the current power of attorney bearing the notarized signature of the appropriate corporate officer shall be included with the Bid Bond. Additionally, the surety issuing the Bid Bond shall be, on the Bid Deadline, an admitted surety insurer (as defined in the California Code of Civil Procedure Section 995.120).

5.2.4 Bid Security will be returned after the contract has been awarded. Notwithstanding the preceding, if a Bidder fails or refuses, within 10 days after receipt of notice of selection, to sign the Agreement or submit to University all of the items required by the Bidding Documents, the University will retain that Bidder's Bid Security. If the Bid Security is in the form of a Bid Bond, the Bid Security will be retained until the University has been appropriately compensated; if the Bid Security is in the form of certified check, the University will negotiate said check and after deducting its damages, return any balance to Bidder.

5.3 SUBMISSION OF BIDS

5.3.1 The Bid Form, Bid Security, and all other documents required to be submitted with the Bid shall be enclosed in a sealed opaque envelope. The envelope shall be addressed to the office designated in the Supplementary Instructions to Bidders for receipt of Bids. The envelope shall be identified with the Project name, Bidder's name and address, and, if applicable, the designated portion of the Project for which the Bid is submitted. If the Bid is sent by mail, the sealed envelope shall be enclosed in a separate mailing envelope with the notation "SEALED BID ENCLOSED" on the face thereof.

5.3.2 Bids shall be deposited at the designated location on or before the Bid Deadline. A Bid received after the Bid Deadline will be returned to Bidder unopened.

5.3.3 Bidder shall assume full responsibility for timely delivery at the location designated for receipt of Bids.

5.3.4 Oral, telephonic, electronic mail (e-mail), facsimile, or telegraphic Bids are invalid and will not be accepted.

5.4 MODIFICATION OR WITHDRAWAL OF BID

5.4.1 Prior to the Bid Deadline, a submitted Bid may be modified or withdrawn by notice to the Facility receiving Bids at the location designated for receipt of Bids. Such notice shall be in writing over

the signature of Bidder and, in order to be effective, must be received on or before the Bid Deadline. A modification so made shall be worded so as not to reveal the amount of the original Bid.

5.4.2 A withdrawn Bid may be resubmitted on or before the Bid Deadline, provided that it then fully complies with the Bidding Requirements.

5.4.3 Bid Security shall be in an amount sufficient for the Bid as modified or resubmitted.

5.4.4 Bids may not be modified, withdrawn, or canceled within 60 days after the Bid Deadline unless otherwise provided in Supplementary Instructions to Bidders.

ARTICLE 6

CONSIDERATION OF BIDS

6.1 OPENING OF BIDS

6.1.1 Bids which have the required identification as stipulated in Article 5.3.1 and are received on or before the Bid Deadline will be opened publicly.

6.2 REJECTION OF BIDS

6.2.1 University will have the right to reject all Bids.

6.2.2 University will have the right to reject any Bid not accompanied by the required Bid Security or any other item required by the Bidding Documents, or a Bid which is in any other way incomplete or irregular.

6.3 AWARD

6.3.1 University will have the right, but is not required, to waive nonmaterial irregularities in a Bid. If the University awards the Contract, it will be awarded to the responsible Bidder submitting the lowest responsive Bid as determined by University and who is not rejected by University for failing or refusing, within 10 days after receipt of notice of selection, to sign the Agreement or submit to University all of the items required by the Bidding Documents.

6.3.2 University will have the right to accept Alternates in any order or combination, unless otherwise specifically provided in the Bidding Documents. The opening of Bids and evaluation of Alternates will be conducted in accordance with a procedure that, at University's option, either (i) prescribes, prior to the time of Bid opening, the order in which Alternates will be selected or (ii) prevents, before the determination of the apparent low Bidder has been made, information that would identify which Bid belongs to which Bidder from being revealed to the representative of the University selecting the Alternates to be used in determining the low Bidder. After determination of the apparent low Bidder has been made, University will publicly disclose the identity of each Bidder that submitted a Bid and the amount of each such Bid.

6.3.3 University will determine the low Bidder on the basis of the sum of the Lump Sum Base Bid plus all Unit Prices multiplied by their respective Estimated Quantities as stated in the Bid Form, if any, plus the daily rate for Compensable Delay multiplied by the "multiplier" as stated in the Bid Form, plus the amounts of all Alternates to be included in the Contract Sum at the time of award.

The Contract Sum will be the sum of the Lump Sum Base Bid and the additive or deductive amounts for all Alternates that University has elected to be included in the Contract Sum as of the time of award.

6.3.4 The University will post the Bid results in a public place at the address where the Bids are received (unless another address is specified in the Bidding Documents).

6.3.5 University will select the apparent lowest responsive and responsible Bidder and notify such Bidder on University's form within 50 days (unless the number of days is modified in Supplementary Instructions to Bidders) after the Bid Deadline or reject all Bids. Within 10 days after receipt of notice of selection as the apparent lowest responsive and responsible Bidder, Bidder shall submit to University all of the following items:

- .1 Three originals of the Agreement signed by Bidder.
- .2 Three originals of the Payment Bond required under Article 11 of the General Conditions.
- .3 Three originals of the Performance Bond required under Article 11 of the General Conditions.
- .4 Certificates of Insurance on form provided by University required under Article 11 of the General Conditions.
- .5 Name of, qualifications of, and references for the Superintendent proposed for the Work.
- .6 Names of all Subcontractors, with their addresses, telephone number, facsimile number, contact person, portion of the Work, California contractor license number, and designation of any Subcontractor as a Small Business Enterprise (SBE), Disadvantaged Business Enterprise (DBE), Women-owned Business Enterprise (WBE) and Disabled Veteran Business Enterprise (DVBE) on Report of Subcontractor Information in the form contained in the Exhibits. Evidence, as required by University, of the reliability and responsibility of the proposed Subcontractors such as statements of experience, statements of financial condition, and references.
- .7 Preliminary Contract Schedule as required under Article 3 of the General Conditions.
- .8 If Bidder wishes to utilize securities in lieu of retention beginning with the first Application for Payment, Selection of Retention Options accompanied by a completed Escrow Agreement for Deposit of Securities in Lieu of Retention and Deposit of Retention in the form contained in the Exhibits.

.9 Cost Breakdown as required by Article 9 of the General Conditions.

6.3.6 Prior to award of the Contract, University will notify Bidder in writing, if University, after due investigation, objects to a Subcontractor or Superintendent proposed by Bidder, in which case Bidder shall propose a substitute acceptable to University. Substitution of Superintendent shall be made in accordance with Article 3 of the General Conditions. Substitution of a Subcontractor shall be made in accordance with Article 5 of the General Conditions. Failure of University to object to a proposed Superintendent or Subcontractor prior to award shall not preclude University from requiring replacement of Superintendent or any Subcontractor based upon information received subsequent to award, information which cannot be properly evaluated prior to award due to time constraints, or information relating to a failure to comply with the requirements of the Contract.

6.3.7 If Bidder submits three originals of the signed Agreement and all other items required to be submitted to University within 10 days after receipt of notice of selection as the apparent lowest responsive and responsible Bidder, and if all such items comply with the requirements of the Bidding Documents and are acceptable to University, University will award the Contract to Bidder by signing the Agreement and returning a signed copy of the Agreement to Bidder.

6.3.8 If University consents to the withdrawal of the Bid of the apparent lowest responsive and responsible Bidder, or the apparent lowest responsive and responsible Bidder fails or refuses to sign the Agreement or submit to University all of the items required by the Bidding Documents, within 10 days after receipt of notice of selection, or that Bidder is not financially or otherwise qualified to perform the Contract, University may reject such Bidder's Bid and select the next apparent lowest responsible Bidder, until all Bids are exhausted, or reject all Bids. Any Bidder whose Bid is rejected because the Bidder has failed or refused, within 10 days after receipt of notice of selection, to sign the Agreement or submit to University all of the items required by the Bidding Documents, shall be liable to the University for all resulting damages.

ARTICLE 7

BID PROTEST

7.1 FILING A BID PROTEST

7.1.1 Any Bidder, person, or entity may file a Bid protest. The protest shall specify the reasons and facts upon which the protest is based and shall be in writing and received by the Facility not later than 5:00 pm on the 3rd business day following:

- .1 if the Bid Form does not contain any Alternate(s), the date of the Bid opening;
- .2 if the Bid Form contains any Alternate(s), the date of posting in a public place of Bid results.

7.1.2 If a Bid is rejected by the Facility, and such rejection is not in response to a Bid protest, any Bidder, person or entity may dispute that rejection by filing a Bid protest (limited to the rejection) in

writing and received by the Facility not later than 5:00 pm on the 3rd business day following the rejected Bidder's receipt of the notice of rejection.

7.1.3 For the purpose of computing any time period in this Article 7, the date of receipt of any notice shall be the date on which the intended recipient of such notice actually received it. Delivery of any notice may be by any means, with verbal or written confirmation of receipt by the intended recipient.

7.2 RESOLUTION OF BID CONTROVERSY

7.2.1 Facility will investigate the basis for the Bid protest and analyze the facts. Facility will notify Bidder whose Bid is the subject of the Bid protest of evidence presented in the Bid protest and evidence found as a result of the investigation, and, if deemed appropriate, afford Bidder an opportunity to rebut such evidence, and permit Bidder to present evidence that it should be allowed to perform the Work. If deemed appropriate by Facility, an informal hearing will be held. Facility will issue a written decision within 15 days following receipt of the Bid protest, unless factors beyond Facility's reasonable control prevent such a resolution, in which event such decision will be issued as expeditiously as circumstances reasonably permit. The decision will state the reasons for the action taken by Facility. A written copy of the decision will be furnished to the protestor, the Bidder whose Bid is the subject of the Bid protest, and all Bidders affected by the decision. As used in this Article 7, a Bidder is affected by the decision on a Bid protest if a decision on the protest could have resulted in the Bidder not being the lowest responsible and responsive Bidder for the Contract. A written copy of the Facility's decision must be received by the protestor, the Bidder whose Bid is the subject of the Bid protest, and all Bidders affected by the decision no later than 3 business days prior to award of the contract.

7.2.2 Notwithstanding the provisions of Article 7.2.1, at the election of Facility, a Bid protest may be referred directly to University's Construction Review Board without prior investigation and review by Facility. The Chair of the Construction Review Board will either decide the Bid protest or appoint a Hearing Officer. If a Hearing Officer is appointed, the Hearing Officer will review the Bid protest in accordance with the provisions of Article 7.2.4.

7.2.3 Bidder whose Bid is the subject of the protest, all Bidders affected by the Facility's decision on the protest, and the protestor have the right to appeal to the Construction Review Board if not satisfied with Facility's decision. The appeal must be in writing and shall specify the decision being appealed and all the facts and circumstances relied upon in support of the appeal. A copy of the appeal must be received by the Chair, Construction Review Board, not later than 5:00 pm on the 3rd business day following appellant's receipt of the written decision of Facility, at the following address:

Chair, Construction Review Board
University of California
Office of the President
1111 Franklin Street, 6th Floor
Oakland, CA 94607-5200
Attention: Director, Construction Services

And, by email to:

constructionreviewboard@ucop.edu

A copy of the appeal must be sent to all parties involved in the Bid protest and to Facility, to the same address and in the same manner as the original protest. An appeal received after 5:00 pm is considered received as of the next business day. If the final date for receipt of an appeal falls on a Saturday, Sunday, or University holiday, the appeal will be considered timely only if received by 5:00 pm on the following business day. The burden of proving timely receipt of the appeal is on the appealing party.

7.2.4 The Chair of the Construction Review Board will review the Facility's decision and the appeal, and issue a written decision, or if appropriate, appoint a Hearing Officer to conduct a hearing and issue a written decision. If a hearing is held, the hearing shall be held not later than the 10th day following the appointment of the Hearing Officer unless the Hearing Officer for good cause determines otherwise. The written decision of the Chair or Hearing Officer will state the basis of the decision, and the decision will be final and not subject to any further appeal to University. The Chair or Hearing Officer may consult with the University's Office of the General Counsel on the decision as to legal form. The University will complete its internal Bid protest procedures before award of the Contract.

SUPPLEMENTARY INSTRUCTIONS TO BIDDERS

1. Requests for clarification or interpretation of the Bidding Documents must be in **writing** and received by **Tuesday, July 7, 2015 at 4:00 P.M.** Questions received after the above-noted deadline may be answered at the discretion of the University's Representative. **Questions may be mailed, E-Mailed to:**

Fran Telechea – University of California, Merced
email: ftelechea@ucmerced.edu

Revisions, additions or deletions will be made by written addenda issued by Design & Construction only.

1. A **NON-MANDATORY** Project Site Visit will be conducted on Wednesday, July 1, 2015 beginning promptly at 9:00 am. Participants shall meet at 2128 Avenue 28, Chowchilla, CA.

If you need accommodations related to disabilities, please call Fran Telechea at (209) 228-4479 at least 3 working days prior to Pre-Bid Conference/Project Site Visit or Bid Opening.

2. Bids will be received on or before the Bid Deadline and only at:
**Hand or Overnight
Delivery Only** University of California, Merced
767 E. Yosemite Ave.
Merced California 95340

3. Bids will be opened at: **2:00 PM**
Tuesday, July 14, 2015
767 E. Yosemite Ave.
Merced California 95340

4. If Contractor fails to meet Agency Compliance milestone as described in the summary of work 01 11 10 part Contractor shall be assessed liquidated damages in the amount of \$1,000.00 per day for each calendar day following the specified date of Agency Compliance for that phase where the Work remains incomplete (Saturdays, Sundays, and holidays included). Liquidated damages in the amount of \$250.00 per day for each calendar day the Contractor fails to meet Substantial Completion as described in the summary of work.

5. Contract Time: Agency Compliance by 10/15/2015, Substantial Completion 12/15/2015 and Final Completion 12/21/2015.

6. Addenda will be issued only by University and only in writing. Addenda will be identified as such and will be emailed to all Planholders, who have provided an email address for receipt of Addenda.

7. Bid results will be posted at the following web address:
<http://www.ucmerced.edu/community/rfprfq.asp>

8. Bidder to note that all costs associated with the small mammal burrowing scope as defined in Section 01 11 00 of the Contract Documents will be handled through the Allowance as defined in Section 01 21 00. Bidder is to competitively bid a Unit Price as defined in Section 01 22 00 which, upon award of contract, will be used to determine the rate at which Bidder will be eligible to receive authorization for payment of the Allowance.

INFORMATION AVAILABLE TO BIDDERS

The following information is made available for the convenience of bidders and is not a part of the Contract. The information is provided subject to the provisions of Article 3 of the General Conditions.

1. State of California, Department of Industrial Relations, Prevailing Wage Determinations for Statewide, Northern California, and Merced County may be found at http://www.dir.ca.gov/DLSR/statistics_research.html
 - A. No special determinations have been received from the Department of Industrial Relations for this project.
 - B. 1st publication date of the Advertisement for Bids.

2. Preliminary Project Schedule

BID FORM

FOR:

PROJECT NO. 660175 1B 19900
LAZY K RESTORATION
UNIVERSITY OF CALIFORNIA MERCED
MERCED COUNTY
MERCED CALIFORNIA

BID TO:

DESIGN & CONSTRUCTION
UNIVERSITY OF CALIFORNIA MERCED
767 E. YOSEMITE AVE., SUITE C
MERCED CALIFORNIA 95340
TELEPHONE: (209) 228-0402

**FOR THE
FOLLOWING
WORK:**

Lazy K Restoration

BID FROM:

(Name of Firm Submitting Bid)

(Address)

(City)

(State)

(Zip Code)

(Telephone Number)

(Fax Number)

(Date Bid Submitted)

Note: All portions of this Bid Form must be completed and the Bid Form must be signed before the Bid is submitted. Failure to do so will result in the Bid being rejected as non-responsive.

1.0 BIDDER'S REPRESENTATIONS

Bidder, represents that a) Bidder and all Subcontractors, regardless of tier, has the appropriate current and active Contractor's licenses required by the State of California and the Bidding Documents; b) it has carefully read and examined the Bidding Documents for the proposed Work on this Project; c) it has examined the site of the proposed Work and all Information Available to Bidders; d) it has become familiar with all the conditions related to the proposed Work, including the availability of labor, materials, and equipment. Bidder hereby offers to furnish all labor, materials, equipment, tools, transportation, and services necessary to complete the proposed Work on this Project in accordance with the Contract Documents for the sums quoted. Bidder further agrees that it will not withdraw its Bid within 60 days after the Bid Deadline, and that, if it is selected as the apparent lowest responsive and responsible Bidder, that it will, within 10 days after receipt of notice of selection, sign and deliver to University the Agreement in triplicate and furnish to University all items required by the Bidding Documents. If awarded the Contract, Bidder agrees to schedule and execute the Work within the Contract Time.

2.0 ADDENDA

Bidder acknowledges that it is Bidder's responsibility to ascertain whether any Addenda have been issued and if so, to obtain copies of such Addenda from University's Facility at the appropriate address stated on Page 1 of this Bid Form. Bidder therefore agrees to be bound by all Addenda that have been issued for this Bid.

3.0 NOT USED

4.0 LUMP SUM BASE BID

\$

--	--

 ,

--	--	--

 ,

--	--	--

 .

--	--

(Place figures in appropriate boxes.)

Bidder includes in the Lump Sum Base Bid the following allowances:
Allowance No. 1: \$100,000.00 for Small Mammal Burrow Excavation

5.0 SELECTION OF APPARENT LOW BIDDER

Refer to the Instructions to Bidders for selection of apparent low bidder.

6.0 UNIT PRICES

The quantities set forth in the Unit Prices are estimates. University does not represent that the actual quantity of any Unit Price item will equal the Estimated Quantity stated below. University will perform the extension of the Unit Price times the respective Estimated Quantity.

Unit Price for: Small Mammal Burrow Excavation as specified in Section 01 22 00.

Estimated Quantity of units: 20 Work Days.

\$

--	--	--

 ,

--	--	--

 ·

--	--

 per 1 Work Day

(Place Unit Price figures in appropriate boxes.)

7.0 DAILY RATE OF COMPENSATION FOR COMPENSABLE DELAYS

Bidder shall determine and provide below the daily rate of compensation for any Compensable Delay caused by University at any time during the performance of the Work.

\$

--	--

 ,

--	--	--

 ·

--	--

 X ¹⁰ multiplier

(Place figures in appropriate boxes.)

Failure to fill in a dollar figure for the daily rate for Compensable Delay shall render the bid non-responsive. University will perform the extension of the daily rate times the multiplier.

The daily rate shown above will be the total amount of Contractor entitlement for each day of Compensable Delay caused by University at any time during the performance of the Work and shall constitute payment in full for all delay costs, direct or indirect (including, without limitation, compensation for all extended home office overhead and extended general conditions), of the Contractor and all subcontractors, suppliers, persons, and entities under or claiming through Contractor on the Project. The number of days of Compensable Delay shown as a "multiplier" above is not intended as an estimate of the number of days of Compensable Delay anticipated by the University. The University will pay the daily rate of compensation only for the actual number of days of Compensable Delay, as defined in the General Conditions; the actual number of days of Compensable Delay may be greater or lesser than the "multiplier" shown above.

8.0 ALTERNATES

NOT USED

9.0 LIST OF SUBCONTRACTORS

Bidder will use Subcontractors for the Work:

Yes _____

If "yes", provide in the spaces below (a) the name, the location of the place of business, and the California contractor license number of each subcontractor who will perform work or labor or render service to the prime contractor in or about the construction of the work or improvement, or a subcontractor licensed by the state of California who, under subcontract to the prime contractor, specially fabricates and installs a portion of the work or improvement according to detailed drawings contained in the plans and specifications, in an amount in excess of one-half of 1 percent of the prime contractor's total bid, (b) the portion of the work which will be done by each subcontractor. The prime contractor shall list only one subcontractor for each such portion as is defined by the prime contractor in its bid.

Portion of the Work Activity (e.g. electrical, mechanical, concrete)	Subcontractor		
	Name of Business	Location of Business (City)	License No.

(Note: Add additional pages if required.)

11.0 BIDDER INFORMATION

TYPE OF ORGANIZATION:

(Corporation, Partnership, Individual, Joint Venture, etc.)

IF A CORPORATION, THE CORPORATION IS ORGANIZED UNDER THE LAWS OF:

THE STATE OF _____
(State)

NAME OF PRESIDENT OF THE CORPORATION:

(Insert Name)

NAME OF SECRETARY OF THE CORPORATION:

(Insert Name)

IF A PARTNERSHIP, NAMES OF ALL GENERAL PARTNERS:

(Insert Names)

CALIFORNIA CONTRACTORS LICENSE(S):

(Classification)

(License Number)

(Expiration Date)

(For Joint Venture, list Joint Venture's license and licenses for all Joint Venture partners.)

12.0 REQUIRED COMPLETED ATTACHMENTS

The following documents are submitted with and made a condition of this Bid:

1. Bid Security in the form of _____
(Bid Bond or Certified Check)

13.0 DECLARATION

I, _____, hereby declare that I am the
(Printed Name)

_____ of _____
(Title) (Name of Bidder)

submitting this Bid Form; that I am duly authorized to execute this Bid Form on behalf of Bidder; and that all information set forth in this Bid Form and all attachments hereto are, to the best of my knowledge, true, accurate, and complete as of its submission date.

I further declare that this bid is not made in the interest of, or on behalf of, any undisclosed person, partnership, company, association, organization, or corporation; that the bid is genuine and not collusive or sham; that the bidder has not directly or indirectly induced or solicited any other bidder to put in a false or sham bid, and has not directly or indirectly colluded, conspired, connived, or agreed with any bidder or anyone else to put in a sham bid, or that anyone shall refrain from bidding; that the bidder has not in any manner, directly or indirectly, sought by agreement, communication, or conference with anyone to fix the bid price of the bidder or any other bidder, or to fix any overhead, profit, or cost element of the bid price, or of that of any other bidder, or to secure any advantage against the public body awarding the contract of anyone interested in the proposed contract; that all statements contained in the bid are true; and, further, that the bidder has not, directly or indirectly, submitted his or her bid price or any breakdown thereof, or the contents thereof, or divulged information or data relative thereto, or paid, and will not pay, any fee to any corporation, partnership, company association, organization, bid depository, or to any member or agent thereof to effectuate a collusive or sham bid.

LAZY K RESTORATION
UNIVERSITY OF CALIFORNIA MERCED
MERCED, CALIFORNIA

PROJECT NO.: **660175 1B 1990**

I declare, under penalty of perjury, that the foregoing is true and correct and that this declaration was

executed at: _____(Name of City if within a City, otherwise Name of County),

in the State of _____, on _____.

(State) (Date)

(Signature)

BID BOND

KNOW ALL PERSONS BY THESE PRESENTS:

That we, _____,

as Principal, and _____, as Surety, are held and firmly bound unto THE REGENTS OF THE UNIVERSITY OF CALIFORNIA, hereinafter called THE REGENTS, in the sum of 10% of the Lump Sum Base Bid amount for payment of which in lawful money of the United States, well and truly to be made, we bind ourselves, our heirs, executors, administrators, successors, and assigns, jointly and severally, firmly by these presents.

THE CONDITION OF THE ABOVE OBLIGATION IS SUCH THAT, WHEREAS, Principal has submitted a Bid for the work described as follows:

LAZY K RESTORATION
UNIVERSITY OF CALIFORNIA MERCED
MERCED, CALIFORNIA
PROJECT NO.: 661075 1B 19900

NOW, THEREFORE, if Principal shall not withdraw said Bid within the time period specified after the Bid Deadline, as defined in the Bidding Documents, or within 60 days after the Bid Deadline if no time period be specified, and, if selected as the apparent lowest responsible Bidder, Principal shall, within the time period specified in the Bidding Documents, do the following:

- (1) Enter into a written agreement, in the prescribed form, in accordance with the Bid.
- (2) File two bonds with THE REGENTS, one to guarantee faithful performance and the other to guarantee payment for labor and materials, as required by the Bidding Documents.
- (3) Furnish certificates of insurance and all other items as required by the Bidding Documents.

In the event of the withdrawal of said Bid within the time period specified, or within 60 days if no time period be specified, or the disqualification of said Bid due to failure of Principal to enter into such agreement and furnish such bonds, certificates of insurance, and all other items as required by the Bidding Documents, if Principal shall pay to THE REGENTS an amount equal to the difference, not to exceed the amount hereof, between the amount specified in said Bid and such larger amount for which THE REGENTS procure the required work covered by said Bid, if the latter be in excess of the former, then this obligation shall be null and void, otherwise to remain in full force and effect.

In the event suit is brought upon this bond by THE REGENTS, Surety shall pay reasonable attorneys' fees and costs incurred by THE REGENTS in such suit.

LAZY K RESTORATION
UNIVERSITY OF CALIFORNIA MERCED
MERCED, CALIFORNIA

PROJECT NO.: **660175 1B 1990**

IN WITNESS WHEREOF, we have hereunto set our hands this _____ day of
, 20__.

Principal: _____
(Name of Firm)

By: _____

Title: _____

Surety: _____
(Name of Firm)

By: _____

Title: _____

Address for Notices:

NOTE: Notary acknowledgement for Surety and Surety's Power of Attorney must be attached.

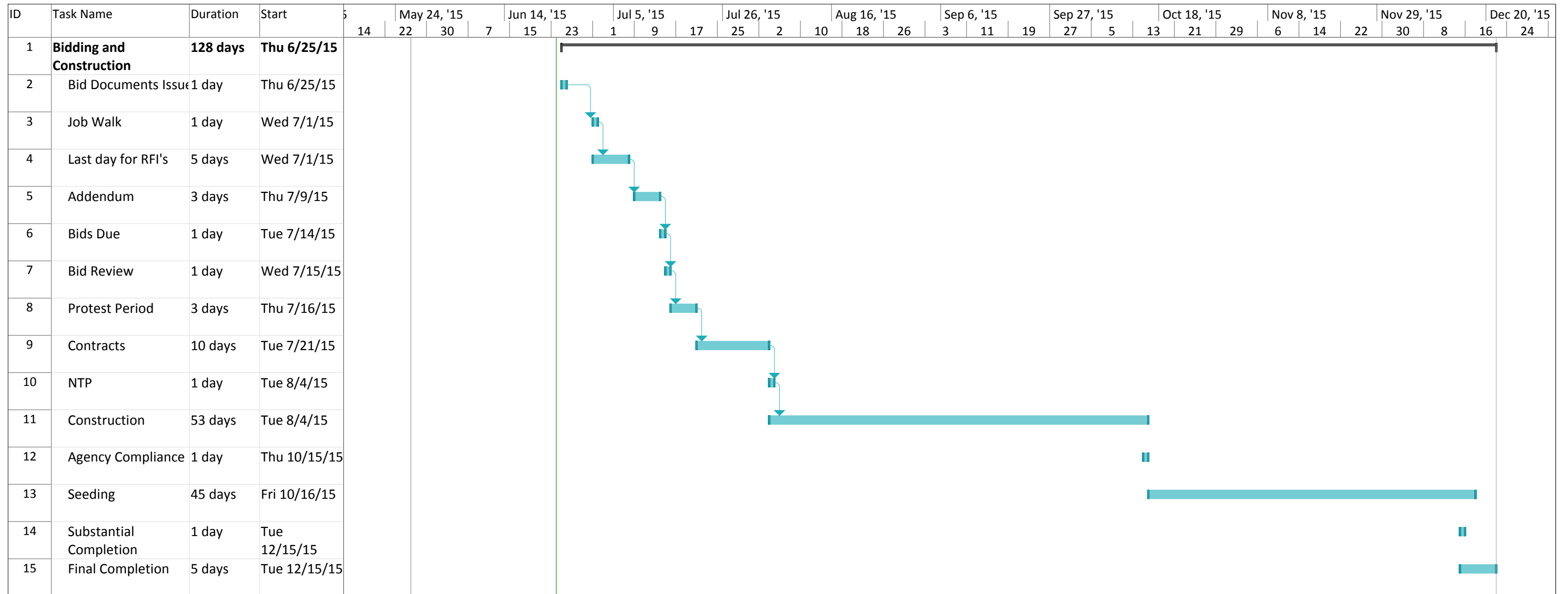

Project: Lazy K 6/24/2015.mpp Date: Wed 6/24/15	Task		Project Summary		Inactive Milestone		Manual Summary Rollup		Deadline	
	Split		External Tasks		Inactive Summary		Manual Summary		Progress	
	Milestone		External Milestone		Manual Task		Start-only		Manual Progress	
	Summary		Inactive Task		Duration-only		Finish-only			

AGREEMENT

THIS AGREEMENT is made as of the ____ day of _____ between the University,
THE REGENTS OF THE UNIVERSITY OF CALIFORNIA,

whose facility is: University of California
Merced Campus

whose address for notices is: Design & Construction
University of California
5200 N. Lake Rd.
Merced, California 95343

and Contractor:
whose address for notices is:

for the Project: Lazy K Restoration
Project No. 661075 1B 19900
University of California Merced
Merced, California

University's Responsible Administrator: Michael Chow
Interim Assistant Vice Chancellor for Design &
Construction

University's Representative is: Fran Telechea
whose address for notices is: Design & Construction
University of California
5200 N. Lake Rd.
Merced, California 95343

Contract Documents for the Work Prepared by: Vollmar
Natural Lands Consulting
1720 Solano Aveune
Berkeley, CA 94704

University and Contractor hereby agree as follows:

ARTICLE 1 WORK - Contractor shall provide all work required by the Contract Documents (the "Work"). Contractor agrees to do additional Work arising from changes ordered by the University pursuant to Article 7 of the General Conditions. Contractor shall (1) pay all sales, consumer and other taxes and (2) obtain and pay for any governmental licenses and permits necessary for the work, other than building and utility permits.

ARTICLE 2 CONTRACT DOCUMENTS - "Contract Documents" means the Advertisement for Bids, Instructions To Bidders, Supplementary Instructions to Bidders, Bid Form, this Agreement, General Conditions, Supplementary Conditions, Exhibits, Specifications, List of Drawings, Drawings, Addenda, Notice to Proceed, Change Orders, Notice of Completion, and all other documents identified in this Agreement of which together form the Contract between University and Contractor for the Work (the "Contract"). The Contract constitutes the complete agreement between University and Contractor and supersedes any previous agreements or understandings.

ARTICLE 3 CONTRACT SUM - Subject to the provisions of the Contract Documents University shall pay to Contractor, for the performance of the Work, \$ _____, the "Contract Sum".

The Contract Sum includes the following Allowances:

(TO BE COMPLETED AT TIME OF AWARD, IF APPLICABLE)

The Contract Sum includes the following Alternates accepted by University:

(TO BE COMPLETED AT TIME OF AWARD, IF APPLICABLE)

Unit prices, if any, are as follows:

(TO BE COMPLETED AT TIME OF AWARD, IF APPLICABLE)

The Contract Sum will be increased by an amount equal to the unit price multiplied by the actual number of units of each unit price item incorporated in the Work.

ARTICLE 4 CONTRACT TIME - Contractor shall commence the Work on the date specified in the Notice to Proceed and fully complete the work within **130 calendar days**, the "Contract Time".

By signing this agreement, Contractor represents to University that the Contract Time is reasonable for completion of the work and that Contractor will complete the Work within the Contract Time. Time limits stated in the Contract Documents are of the essence of the Contract.

ARTICLE 5 LIQUIDATED DAMAGES - If Contractor fails to meet **Agency Compliance** milestones as described in the summary of work 01 11 00 part 1 Contractor shall be assessed liquidated damages in the amount of \$1,000.00 per day for each calendar day following the specified date of **Agency Compliance** for that phase where the Work remains incomplete (Saturdays, Sundays, and holidays included).). Liquidated damages in the amount of \$250.00 per day for each calendar day the Contractor fails to meet Substantial Completion as described in the summary of work.

ARTICLE 6 COMPENSABLE DELAY - If Contractor is entitled to an increase in the Contract Sum as a result of a Compensable Delay, determined pursuant to Articles 7 and 8 of the General Conditions, the Contract Sum will be increased by the sum of \$___ per day for each day for which such compensation is payable.

ARTICLE 7 DUE AUTHORIZATION - The person or persons signing this Agreement on behalf of Contractor hereby represent and warrant to University that this Agreement is duly authorized, signed, and delivered by Contractor.

THIS AGREEMENT is entered into by University and Contractor as of the date set forth above.

CONTRACTOR:

(Name of Firm)

(Type of Organization)

By: _____
(Signature)

(Printed Name)

(Title)

California Contractor's License(s):

(Name of Licensee)

(Classification and License Number)

(Expiration Date)

Employer Identification Number

(EIN NUMBER)

UNIVERSITY:

The Regents of the University of California

Physical Planning, Design & Construction,
Merced Campus
(Facility)

By: _____
(Signature)

Michael Chow
(Printed Name)

Interim Assistant Vice Chancellor for Design &
Construction
(Title)

Attach notary acknowledgment for all signatures of Contractor. If signed by other than the sole proprietor, a general partner, or corporate officer, attach original notarized Power of Attorney or Corporate Resolution.

**GENERAL CONDITIONS – LONG FORM
TABLE OF CONTENTS**

ARTICLE 1. GENERAL PROVISIONS

- 1.1 Basic Definitions
- 1.2 Ownership and Use of Contract Documents
- 1.3 Interpretation

ARTICLE 2. UNIVERSITY

- 2.1 Information and Services Provided by University
- 2.2 Access to Project Site
- 2.3 University's Right to Stop the Work
- 2.4 University's Right to Carry Out the Work
- 2.5 University's Right to Replace University's Representative

ARTICLE 3. CONTRACTOR

- 3.1 Review of Contract Documents and Field Conditions by Contractor
- 3.2 Supervision and Construction Procedures
- 3.3 Labor and Materials
- 3.4 Contractor's Warranty
- 3.5 Taxes
- 3.6 Permits, Fees, and Notices
- 3.7 Applicable Code Requirements
- 3.8 Superintendent
- 3.9 Schedules Required of Contractor
- 3.10 As-Built Documents
- 3.11 Documents and Samples at Project Site
- 3.12 Shop Drawings, Product Data, and Samples
- 3.13 Use of Site and Clean Up
- 3.14 Cutting, Fitting, and Patching
- 3.15 Access to Work
- 3.16 Royalties and Patents
- 3.17 Differing Site Conditions
- 3.18 Concealed, Unforeseen, or Unknown Conditions or Events
- 3.19 Hazardous Materials
- 3.20 Information Available to Bidders
- 3.21 Liability for and Repair of Damaged Work
- 3.22 Indemnification

ARTICLE 4. ADMINISTRATION OF THE CONTRACT

- 4.1 Administration of the Contract by University's Representative
- 4.2 Contractor Change Order Requests
- 4.3 Claims
- 4.4 Assertion of Claims
- 4.5 Decision of University's Representative on Claims
- 4.6 Mediation
- 4.7 Arbitration
- 4.8 Waiver

ARTICLE 5. SUBCONTRACTORS

- 5.1 Award of Subcontracts and Other Contracts for Portions of the Work
- 5.2 Subcontractual Relations
- 5.3 Contingent Assignment of Subcontracts

ARTICLE 6. CONSTRUCTION BY UNIVERSITY OR BY SEPARATE CONTRACTORS

- 6.1 University's Right to Perform Construction and to Award Separate Contracts
- 6.2 Mutual Responsibility
- 6.3 University's Right to Clean Up

ARTICLE 7. CHANGES IN THE WORK

- 7.1 Changes
- 7.2 Definitions
- 7.3 Change Order Procedures
- 7.4 Field Orders
- 7.5 Variation in Quantity of Unit Price Work
- 7.6 Waiver

ARTICLE 8. CONTRACT TIME

- 8.1 Commencement of the Work
- 8.2 Progress and Completion
- 8.3 Delay
- 8.4 Adjustment of the Contract Time for Delay
- 8.5 Compensation for Delay
- 8.6 Waiver

ARTICLE 9. PAYMENTS AND COMPLETION

- 9.1 Cost Breakdown
- 9.2 Progress Payment
- 9.3 Application For Payment
- 9.4 Certificate For Payment
- 9.5 Deposit of Securities in Lieu of Retention and Deposit of Retention Into Escrow
- 9.6 Beneficial Occupancy
- 9.7 Substantial Completion
- 9.8 Final Completion and Final Payment

ARTICLE 10. PROTECTION OF PERSONS AND PROPERTY

- 10.1 Safety Precautions and Programs
- 10.2 Safety of Persons and Property
- 10.3 Emergencies

ARTICLE 11. INSURANCE AND BONDS

- 11.1 Contractor's Insurance
- 11.2 Builder's Risk Property Insurance
- 11.3 Performance Bond and Payment Bond

ARTICLE 12. UNCOVERING AND CORRECTION OF WORK

- 12.1 Uncovering of Work
- 12.2 Correction of Defective Work and Guarantee to Repair Period

ARTICLE 13. TERMINATION OR SUSPENSION OF THE CONTRACT

- 13.1 Termination by Contractor
- 13.2 Termination by University for Cause
- 13.3 Suspension by University for Convenience
- 13.4 Termination by University for Convenience

ARTICLE 14. STATUTORY AND OTHER REQUIREMENTS

- 14.1 Patient Health Information
- 14.2 Nondiscrimination
- 14.3 Prevailing Wage Rates
- 14.4 Payroll Records
- 14.5 Apprentices
- 14.6 Work Day

ARTICLE 15. MISCELLANEOUS PROVISIONS

- 15.1 Governing Law
- 15.2 Successors and Assigns
- 15.3 Rights and Remedies
- 15.4 Survival
- 15.5 Complete Agreement
- 15.6 Severability of Provisions
- 15.7 University's Right to Audit
- 15.8 Methods of Delivery for Specified Documents
- 15.9 Time of the Essence
- 15.10 Mutual Duty to Mitigate

**ARTICLE 1
GENERAL PROVISIONS**

1.1 BASIC DEFINITIONS

1.1.1 APPLICABLE CODE REQUIREMENTS

The term "Applicable Code Requirements" means all laws, statutes, the most recent building codes, ordinances, rules, regulations, and lawful orders of all public authorities having jurisdiction over University, Contractor, any Subcontractor, the Project, the Project site, the Work, or the prosecution of the Work including without limitation the requirements set forth in Article 3.7.

1.1.2 APPLICATION FOR PAYMENT

The term "Application For Payment" means the submittal from Contractor wherein payment for certain portions of the completed Work is requested in accordance with Article 9.

1.1.3 BENEFICIAL OCCUPANCY

The term "Beneficial Occupancy" means the University's occupancy or use of any part of the Work in accordance with Article 9.

1.1.4 CERTIFICATE FOR PAYMENT

The term "Certificate For Payment" means the form signed by University's Representative attesting to the Contractor's right to receive payment for certain completed portions of the Work in accordance with Article 9.

1.1.5 CHANGE ORDER

See Article 7.2 of the General Conditions.

1.1.6 CLAIM

See Article 4.3 of the General Conditions.

1.1.7 COMPENSABLE DELAY

The term "Compensable Delay" means a delay that entitles the Contractor to an adjustment of the Contract Sum and an adjustment of the Contract Time pursuant to Articles 7 and 8 of the General Conditions.

1.1.8 CONTRACT

The term "Contract" shall have the meaning identified in Article 2 of the Agreement.

1.1.9 CONTRACT DOCUMENTS

The term "Contract Documents" means all documents listed in Article 2 of the Agreement, as modified by Change Order, including but not limited to the Drawings and Specifications.

1.1.10 CONTRACT MILESTONE

The term "Contract Milestone" means any requirement in the Contract Documents that reflects a planned point in time for the start or completion of a portion of the Work measured from i) the date of the Notice to Proceed or ii) the date of another Contract Milestone defined in the Contract Documents, as applicable.

1.1.11 CONTRACT SCHEDULE

The term "Contract Schedule" means the graphical representation of a practical plan, in accordance with the Specifications, to perform and complete the Work within the Contract Time in accordance with Article 3.

1.1.12 CONTRACT SUM

The term "Contract Sum" means the amount of compensation stated in the Agreement for the performance of the Work, as adjusted by Change Order.

1.1.13 CONTRACT TIME

The term "Contract Time" means the number of days set forth in the Agreement, as adjusted by Change Order, within which Contractor must achieve Final Completion.

1.1.14 CONTRACTOR

The term "Contractor" means the person or firm identified as such in the Agreement and is referred to throughout the Contract Documents as if singular in number.

1.1.15 CONTRACTOR FEE

See Article 7.3 of the General Conditions.

1.1.16 COST OF EXTRA WORK

See Article 7.3 of the General Conditions.

1.1.17 DAY

The term "day," as used in the Contract Documents, shall mean calendar day, unless otherwise specifically provided.

1.1.18 DEFECTIVE WORK

The term "Defective Work" means work that is unsatisfactory, faulty, omitted, incomplete, deficient, or does not conform to the requirements of the Contract Documents, directives of University's Representative, or the requirements of any inspection, reference standard, test, or approval specified in the Contract Documents.

1.1.19 DRAWINGS

The term "Drawings" means the graphic and pictorial portions of the Contract Documents showing the design, location, and dimensions of the Work, generally including plans, elevations, sections, details, schedules, and diagrams. The Drawings are listed in the List of Drawings.

1.1.20 EXCUSABLE DELAY

The term "Excusable Delay" means a delay that entitles the Contractor to an adjustment of the Contract Time but not an adjustment of the Contract Sum, pursuant to Articles 7 and 8 of the General Conditions.

1.1.21 EXTRA WORK

The term "Extra Work" means Work beyond or in addition to the Work required by the Contract Documents.

1.1.22 FIELD ORDER

See Article 7.2 of the General Conditions.

1.1.23 FINAL COMPLETION

The term "Final Completion" means the date at which the Work has been fully completed in accordance with the requirements of the Contract Documents pursuant to Article 9.8.1 of the General Conditions.

1.1.24 GUARANTEE TO REPAIR PERIOD

See Article 12.2 of the General Conditions.

1.1.25 HAZARDOUS MATERIAL

The term "Hazardous Material" means any substance or material identified as hazardous under any California or federal statute governing handling, disposal and/or cleanup of any such substance or material.

1.1.26 PROJECT

The term "Project" means the Work of the Contract and all other work, labor, equipment, and materials necessary to accomplish the Project . The Project may include construction by University or by Separate

Contractors.

1.1.27 SEPARATE CONTRACTOR

The term "Separate Contractor" means a person or firm under separate contract with University performing other work related to the Project.

1.1.28 SHOP DRAWINGS, PRODUCT DATA, AND SAMPLES

See Article 3.12 of the General Conditions.

1.1.29 SPECIFICATIONS

The term "Specifications" means that portion of the Contract Documents consisting of the written requirements for materials, equipment, construction systems, standards and workmanship for the Work, and performance of related services.

1.1.30 SUBCONTRACTOR

The term "Subcontractor" means a person or firm that has a contract with Contractor or with a Subcontractor to perform a portion of the Work. Unless otherwise specifically provided, the term Subcontractor includes Subcontractors of all tiers.

1.1.31 SUBSTANTIAL COMPLETION

See Article 9.7 of the General Conditions.

1.1.32 SUPERINTENDENT

The term "Superintendent" means the person designated by Contractor to represent Contractor at the Project site in accordance with Article 3.

1.1.33 TIER

The term "tier" means the contractual level of a Subcontractor or supplier with respect to Contractor. For example, a first-tier Subcontractor is under subcontract with Contractor, a second-tier Subcontractor is under subcontract with a first-tier Subcontractor, and so on.

1.1.34 UNEXCUSABLE DELAY

The term "Unexcusable Delay" means a delay that does not entitle the Contractor to an adjustment of the Contract Sum and does not entitle the Contractor to an adjustment of the Contract Time.

1.1.35 UNILATERAL CHANGE ORDER.

See Article 7.2 of the General Conditions.

1.1.36 UNIVERSITY

The term "University" means The Regents of the University of California.

1.1.37 UNIVERSITY'S BUILDING OFFICIAL

The term "University's Building Official" means the individual the University has designated to act in the capacity as the "Building Official" as defined by the California Building Standards Code. The University's Building Official will determine whether the Work complies with Applicable Code Requirements and will determine whether and when it is appropriate to issue a Certificate of Occupancy.

1.1.38 UNIVERSITY'S REPRESENTATIVE

The term "University's Representative" means the person or firm identified as such in the Agreement.

1.1.39 UNIVERSITY'S RESPONSIBLE ADMINISTRATOR

The term "University's Responsible Administrator" means the person, or his or her authorized designee, who is authorized to execute the Agreement, Change Orders, Field Orders, and other applicable Contract

Documents on behalf of the University.

1.1.40 WORK

The term "Work" means all construction, services and other requirements of the Contract Documents as modified by Change Order, whether completed or partially completed, and includes all labor, materials, equipment, tools, and services provided or to be provided by Contractor to fulfill Contractor's obligations. The Work may constitute the whole or a part of the Project.

1.2 OWNERSHIP AND USE OF CONTRACT DOCUMENTS

1.2.1 The Contract Documents and all copies thereof furnished to or provided by Contractor are the property of the University and are not to be used on other work.

1.3 INTERPRETATION

1.3.1 The Contract Documents are complementary and what is required by one shall be as binding as if required by all. In the case of conflict between terms of the Contract Documents, the following order of precedence shall apply:

- .1 The Agreement,
- .2 The Supplementary Conditions,
- .3 The General Conditions,
- .4 The Specifications,
- .5 The Drawings.

1.3.2 With respect to the Drawings, figured dimensions shall control over scaled measurements and specific details shall control over typical or standard details.

1.3.3 With respect to the Contract Documents, Addenda shall govern over other portions of the Contract Documents to the extent specifically noted; subsequent Addenda shall govern over prior Addenda only to the extent specifically noted.

1.3.4 Organization of the Specifications into various subdivisions and the arrangement of the Drawings shall not control Contractor in dividing the Work among Subcontractors or in establishing the extent of work to be performed by any trade.

1.3.5 Unless otherwise stated in the Contract Documents, technical words and abbreviations contained in the Contract Documents are used in accordance with commonly understood construction industry meanings; and non-technical words and abbreviations are used in accordance with their commonly understood meanings.

1.3.6 The Contract Documents may omit modifying words such as "all" and "any," and articles such as "the" and "an," but the fact that a modifier or an article is absent from one statement and appears in another is not intended to affect the interpretation of either statement. The use of the word "including," when following any general statement, shall not be construed to limit such statement to specific items or matters set forth immediately following such word or to similar items or matters, whether or not nonlimiting language (such as "without limitation," "but not limited to," or words of similar import) is used with reference thereto, but rather shall be deemed to refer to all other items or matters that could reasonably fall within the broadest possible scope of such general statement.

1.3.7 Whenever the context so requires, the use of the singular number shall be deemed to include the plural and vice versa. Each gender shall be deemed to include any other gender, and each shall include

corporation, partnership, trust, or other legal entity whenever the context so requires. The captions and headings of the various subdivisions of the Contract Documents are intended only for reference and convenience and in no way define, limit, or prescribe the scope or intent of the Contract Documents or any subdivision thereof.

ARTICLE 2 UNIVERSITY

2.1 INFORMATION AND SERVICES PROVIDED BY UNIVERSITY

2.1.1 If required for performance of the Work, as determined by University's Representative, University will make available a survey describing known physical characteristics, boundaries, easements, and utility locations for the Project site.

2.1.2 University is not subject to any requirement to obtain or pay for local building permits, inspection fees, plan checking fees, or certain utility fees. Except as otherwise provided in the Contract Documents, University will obtain and pay for any utility permits, demolition permits, easements, and government approvals for the use or occupancy of permanent structures required in connection with the Work.

2.1.3 Contractor will be furnished, free of charge, such copies of the Contract Documents as University deems reasonably necessary for execution of the Work.

2.2 ACCESS TO PROJECT SITE

2.2.1 University will provide, no later than the date designated in the Contract Schedule accepted by University's Representative, access to the lands and facilities upon which the Work is to be performed, including such access and other lands and facilities designated in the Contract Documents for use by Contractor.

2.3 UNIVERSITY'S RIGHT TO STOP THE WORK

2.3.1 If Contractor fails to correct Defective Work as required by Article 12.2 or fails to perform the Work in accordance with the Contract Documents, University or University's Representative may direct Contractor to stop the Work, or any portion thereof, until the cause for such order has been eliminated by Contractor. Contractor shall not be entitled to any adjustment of Contract Time or Contract Sum as a result of any such order. University and University's Representative have no duty or responsibility to Contractor or any other party to exercise the right to stop the Work.

2.4 UNIVERSITY'S RIGHT TO CARRY OUT THE WORK

2.4.1 If Contractor fails to carry out the Work in accordance with the Contract Documents, fails to provide sufficient labor, materials, equipment, tools, and services to maintain the Contract Schedule, or otherwise fails to comply with any material term of the Contract Documents, and, after receipt of written notice from University, fails within 2 days, excluding Saturdays, Sundays and legal holidays, or within such additional time as the University may specify, to correct such failure, University may, without prejudice to other remedies University may have, correct such failure at Contractor's expense. In such case, University will be entitled to deduct from payments then or thereafter due Contractor the cost of correcting such failure, including without limitation compensation for the additional services and expenses of University's consultants made necessary thereby. If payments then or thereafter due Contractor are not sufficient to cover such amounts, Contractor shall pay the additional amount to University.

2.5 UNIVERSITY'S RIGHT TO REPLACE UNIVERSITY'S REPRESENTATIVE

2.5.1 University may at any time and from time to time, without prior notice to or approval of Contractor, replace University's Representative with a new University's Representative. Upon receipt of

notice from University informing Contractor of such replacement and identifying the new University's representative, Contractor shall recognize such person or firm as University's Representative for all purposes under the Contract Documents.

ARTICLE 3 CONTRACTOR

3.1 REVIEW OF CONTRACT DOCUMENTS AND FIELD CONDITIONS BY CONTRACTOR

3.1.1 Contractor and its Subcontractors shall review and compare each of the Contract Documents with the others and with information furnished or made available by University, and shall promptly report in writing to University's Representative any errors, inconsistencies, or omissions in the Contract Documents or inconsistencies with Applicable Code Requirements observed by Contractor or its Subcontractors.

3.1.2 Contractor and its Subcontractors shall take field measurements, verify field conditions, and carefully compare with the Contract Documents such field measurements, conditions, and other information known to Contractor before commencing the Work. Errors, inconsistencies, or omissions discovered at any time shall be promptly reported in writing to University's Representative.

3.1.3 If Contractor and its Subcontractors performs any construction activity involving an error, inconsistency, or omission referred to in Articles 3.1.1 and 3.1.2, without giving the notice required in those Articles and obtaining the written consent of University's Representative, Contractor shall be responsible for the resultant losses, including, without limitation, the costs of correcting Defective Work.

3.2 SUPERVISION AND CONSTRUCTION PROCEDURES

3.2.1 Contractor shall supervise, coordinate, and direct the Work using Contractor's best skill and attention. Contractor shall be solely responsible for and have control over construction means, methods, techniques, sequences, procedures, and the coordination of all portions of the Work.

3.2.2 Contractor shall be responsible to University for acts and omissions of Contractor's agents, employees, and Subcontractors, and their respective agents and employees.

3.2.3 Contractor shall not be relieved of its obligation to perform the Work in accordance with the Contract Documents either by acts or omissions of University or University's Representative in the administration of the Contract, or by tests, inspections, or approvals required or performed by persons or firms other than Contractor.

3.2.4 Contractor shall be responsible for inspection of all portions of the Work, including those portions already performed under this Contract, to determine that such portions conform to the requirements of the Contract and are ready to receive subsequent Work.

3.2.5 Contractor shall at all times maintain good discipline and order among its employees and Subcontractors. Contractor shall provide competent, fully qualified personnel to perform the Work.

3.3 LABOR AND MATERIALS

3.3.1 Unless otherwise provided in the Contract, Contractor shall provide and pay for all labor, materials, equipment, tools, construction equipment and machinery, water, heat, utilities, transportation, and other facilities and services necessary for proper execution and Final Completion of the Work, whether temporary or permanent and whether or not incorporated or to be incorporated in the Work.

3.4 CONTRACTOR'S WARRANTY

3.4.1 Contractor warrants to University that all materials and equipment used in or incorporated into the Work will be of good quality, new, and free of liens, claims, and security interests of third parties; that the Work will be of good quality and free from defects; and that the Work will conform with the requirements of the Contract. If required by University's Representative, Contractor shall furnish satisfactory evidence as to the kind and quality of materials and equipment.

3.5 TAXES

3.5.1 Contractor shall pay all sales, consumer, use, and similar taxes for the Work or portions thereof provided by Contractor.

3.6 PERMITS, FEES, AND NOTICES

3.6.1 Except for the permits and approvals which are to be obtained by University or the requirements with respect to which University is not subject as provided in Article 2.1.2, Contractor shall secure and pay for all permits, approvals, government fees, licenses, and inspections necessary for the proper execution and performance of the Work. Contractor shall deliver to University all original licenses, permits, and approvals obtained by Contractor in connection with the Work prior to the final payment or upon termination of the Contract, whichever is earlier.

3.7 APPLICABLE CODE REQUIREMENTS

3.7.1 Contractor shall perform the Work in accordance with the following Applicable Code Requirements:

- .1 All laws, statutes, the most recent building codes, ordinances, rules, regulations, and lawful orders of all public authorities having jurisdiction over University, Contractor, any Subcontractor, the Project, the Project site, the Work, or the prosecution of the Work.
- .2 All requirements of any insurance company issuing insurance required hereunder.
- .3 The Federal Occupational Safety and Health Act and all other Applicable Code Requirements relating to safety.
- .4 Applicable titles in the State of California Code of Regulations.
- .5 Applicable sections in the State of California Labor Code.
- .6 All Applicable Code Requirements relating to nondiscrimination, payment of prevailing wages, payroll records, apprentices, and work day.

Without limiting the foregoing, Contractor shall comply with the provisions regarding nondiscrimination, payment of prevailing wages, payroll records, apprentices, and work day set forth in Article 14.

3.7.2 Contractor shall comply with and give notices required by all Applicable Code Requirements, including all environmental laws and all notice requirements under the State of California Safe Drinking Water and Enforcement Act of 1986 (State of California Health and Safety Code Section 25249.5 and applicable sections that follow). Contractor shall promptly notify University's Representative in writing if Contractor becomes aware during the performance of the Work that the Contract Documents are at variance with Applicable Code Requirements.

3.7.3 If Contractor performs Work which it knows or should know is contrary to Applicable Code Requirements, without prior notice to University and University's Representative, Contractor shall be responsible for such Work and any resulting damages including, without limitation, the costs of correcting Defective Work.

3.8 SUPERINTENDENT

3.8.1 Contractor shall employ a competent Superintendent satisfactory to University who shall be in attendance at the Project site at all times during the performance of the Work. Superintendent shall represent Contractor and communications given to and received from Superintendent shall be binding on Contractor.

3.8.2 Failure to maintain a Superintendent on the Project site at all times Work is in progress shall be considered a material breach of this Contract, entitling University to terminate the Contract or alternatively, issue a stop Work order until the Superintendent is on the Project site. If, by virtue of issuance of said stop Work order, Contractor fails to complete the Contract on time, Contractor will be assessed Liquidated Damages in accordance with the Agreement.

3.8.3 The Superintendent approved for the Project must be able to read, write and verbally communicate in English.

3.8.4 The Superintendent may not perform the Work of any trade, pick-up materials, or perform any Work not directly related to the supervision and coordination of the Work at the Project site when Work is in progress.

3.9 SCHEDULES REQUIRED OF CONTRACTOR

3.9.1 Contractor shall submit a Preliminary Contract Schedule to University's Representative in the form and within the time limit required by the Specifications. University's Representative will review the Preliminary Contract Schedule with Contractor within the time limit required by the Specifications, or, if no such time period is specified, within a reasonable period of time.

3.9.2 Contractor shall submit a Contract Schedule and updated Contract Schedules to University's Representative in the form and within the time limits required by the Specifications and acceptable to University's Representative. University's Representative will determine acceptability of the Contract Schedule and updated Contract Schedules within the time limits required by the Specifications, or if no such time period is specified, within a reasonable period of time. If University's Representative deems the Contract Schedule or updated Contract Schedule unacceptable, it shall specify in writing to Contractor the basis for its objection.

3.9.3 The Preliminary Contract Schedule, the Contract Schedule, and updated Contract Schedules shall represent a practical plan to complete the Work within the Contract Time. Schedules showing the Work completed in less than the Contract Time may be acceptable if judged by University's Representative to be practical. Schedules showing the Work completed beyond the Contract Time may be submitted under the following circumstances:

- .1 If accompanied by a Change Order Request seeking an adjustment of the Contract Time consistent the requirements of paragraph 8.4 for Adjustment of the Contract Time for Delay.; or
- .2 If the Contract Time has passed, or if it is a practical impossibility to complete the Work within the Contract Time, then the updated Contract Schedule or fragnet schedule shall show completion at the earliest practical date.

University's Representative will timely review the updated Contract Schedule or Fragnet Schedule submitted by Contractor. If University's Representative determines that additional supporting data are necessary to fully evaluate the updated Contract Schedule or Fragnet Schedule, University's Representative will request such additional supporting data in writing. Such data shall be furnished no later than 10 days after the date of such request. University's Representative will render a decision promptly and in any case within 30 days after the later of the receipt of the updated Contract Schedule or Fragnet Schedule or the deadline for furnishing such additional supporting data. Failure of University's Representative to render a

decision by the applicable deadline will be deemed a decision denying approval of the updated Contract Schedule or Fragnet Schedule.

Acceptance of any schedule showing completion beyond the Contract Time by University's Representative shall not change the Contract Time and is without prejudice to any right of the University. The Contract Time, not the Contract Schedule, shall control in the determination of liquidated damages payable by Contractor under Article 4 and Article 5 of the Agreement and in the determination of any delay under Article 8 of the General Conditions.

3.9.4 If a schedule showing the Work completed in less than the Contract Time is accepted, Contractor shall not be entitled to extensions of the Contract Time for Excusable Delays or Compensable Delays or to adjustments of the Contract Sum for Compensable Delays until such delays extend the Final Completion of the Work beyond the expiration of the Contract Time.

3.9.5 Contractor shall prepare and keep current to the reasonable satisfaction of University's Representative, a Submittal Schedule in the form contained in the Exhibits, for each submittal, as required by the Specifications, and that are coordinated with the other activities in the Contract Schedule.

3.9.6 The Preliminary Contract Schedule, Contract Schedule, and the Updated Contract Schedules shall meet the following requirements:

- .1 Schedules must be suitable for monitoring progress of the Work.
- .2 Schedules must provide necessary data about the timing for University decisions and University furnished items.
- .3 Schedules must be in sufficient detail to demonstrate adequate planning for the Work.
- .4 Schedules must represent a practical plan to perform and complete the Work within the Contract Time.

3.9.7 University's Representative's review of the form and general content of the Preliminary Contract Schedule, Contract Schedule, and Updated Contract Schedules is for the purpose of determining if the above-listed requirements have been satisfied.

3.9.8 Contractor shall plan, develop, supervise, control, and coordinate the performance of the Work so that its progress and the sequence and timing of Work will permit its completion within the Contract Time, any Contract milestones and any Contract phases.

3.9.9 In preparing the Preliminary Contract Schedule, the Contract Schedule, and updated Contract Schedules, Contractor shall obtain such information and data from Subcontractors as may be required to develop a reasonable and appropriate schedule for performance of the work and shall provide such information and data to the University's Representative upon request. Contractor shall continuously obtain from Subcontractors information and data about the planning for and progress of the Work and the delivery of equipment, shall coordinate and integrate such information and data into updated Contract Schedules, as appropriate, and shall monitor the progress of the Work and the delivery of equipment.

3.9.10 Contractor shall act as the expeditor of potential and actual delays, interruptions, hindrances, or disruptions for its own forces and those forces of Subcontractors, regardless of tier.

3.9.11 Contractor shall cooperate with University's Representative in the development of the Contract Schedule and updated Contract Schedules. University's Representative's acceptance of or its review comments about any schedule or scheduling data shall not relieve Contractor from its sole responsibility to plan for, perform, and complete the Work within the Contract Time. Acceptance of or review comments about any schedule shall not transfer responsibility for any schedule to University's Representative or University nor imply their agreement with (1) any assumption upon which such schedule is based or (2) any matter underlying or contained in such schedule. Failure of University's Representative to discover errors or omissions in schedules that it has reviewed, or to inform Contractor that Contractor, Subcontractors, or others are behind schedule, or to direct or enforce procedures for complying with the

Contract Schedule shall not relieve Contractor from its sole responsibility to perform and complete the Work within the Contract Time and shall not be a cause for an adjustment of the Contract Time or the Contract Sum.

3.10 AS-BUILT DOCUMENTS

3.10.1 Contractor shall maintain one set of As-built drawings and specifications, which shall be kept up to date during the Work of the Contract. All changes which are incorporated into the Work which differ from the documents as drawn and written shall be noted on the As-built set. Notations shall reflect the actual materials, equipment and installation methods used for the Work and each revision shall be initialed and dated by Superintendent. Prior to filing of the Notice of Completion each drawing and the specification cover shall be signed by Contractor and dated attesting to the completeness of the information noted therein. As-built Documents shall be turned over to the University's Representative and shall become part of the Record Documents.

3.11 DOCUMENTS AND SAMPLES AT PROJECT SITE

3.11.1 Contractor shall maintain the following at the Project site:

- .1 One as-built copy of the Contract Documents, in good order and marked to record current changes and selections made during construction.
- .2 The current accepted Contract Schedule.
- .3 Shop Drawings, Product Data, and Samples.
- .4 All other required submittals.

These shall be available to University's Representative and shall be delivered to University's Representative for submittal to University upon the earlier of Final Completion or termination of the Contract.

3.12 SHOP DRAWINGS, PRODUCT DATA, AND SAMPLES

3.12.1 Definitions:

- .1 Shop Drawings are drawings, diagrams, schedules, and other data specially prepared for the Work by Contractor or a Subcontractor to illustrate some portion of the Work.
- .2 Product Data are illustrations, standard schedules, performance charts, instructions, brochures, diagrams, and other information furnished by Contractor to illustrate or describe materials or equipment for some portion of the Work.
- .3 Samples are physical examples which illustrate materials, equipment, or workmanship and establish standards by which the Work will be judged.

3.12.2 Shop Drawings, Product Data, Samples, and similar submittals are not Contract Documents. Their purpose is to demonstrate, for those portions of the Work for which submittals are required, how Contractor proposes to conform to the information given and the design concept expressed in the Contract Documents.

3.12.3 Contractor shall review, approve, and submit to University's Representative Shop Drawings, Product Data, Samples, and similar submittals required by the Contract Documents with reasonable promptness and in such sequence as to cause no delay in the Work or in the activities of University or of Separate Contractors. Submittals made by Contractor which are not required by the Contract Documents may be returned without action by University's Representative.

3.12.4 Contractor shall perform no portion of the Work requiring submittal and review of Shop Drawings, Product Data, Samples, or similar submittals until the respective submittal has been reviewed by University's Representative and no exceptions have been taken by University's Representative. Such Work shall be in accordance with approved submittals and the Contract Documents.

3.12.5 By approving and submitting Shop Drawings, Product Data, Samples, and similar submittals, Contractor represents that it has determined or verified materials and field measurements and conditions related thereto, and that it has checked and coordinated the information contained within such submittals with the requirements of the Contract Documents and Shop Drawings for related Work.

3.12.6 If Contractor discovers any conflicts, omissions, or errors in Shop Drawings or other submittals, Contractor shall notify University's Representative and receive instruction before proceeding with the affected Work.

3.12.7 Contractor shall not be relieved of responsibility for deviations from requirements of the Contract Documents by University's Representative's review of Shop Drawings, Product Data, Samples, or similar submittals, unless Contractor has specifically informed University's Representative in writing of such deviation at the time of submittal and University's Representative has given written approval of the specific deviation. Contractor shall not be relieved of responsibility for errors or omissions in Shop Drawings, Product Data, Samples, or similar submittals by University's Representative's review, acceptance, comment, or approval thereof.

3.12.8 Contractor shall direct specific attention, in writing or on resubmitted Shop Drawings, Product Data, Samples, or similar submittals, to revisions other than those requested by University's Representative on previous submittals.

3.13 USE OF SITE AND CLEAN UP

3.13.1 Contractor shall confine operations at the Project site to areas permitted by law, ordinances, permits, and the Contract Documents. Contractor shall not unreasonably encumber the Project site with materials or equipment.

3.13.2 Contractor shall, during performance of the Work, keep the Project site and surrounding area free from the accumulation of excess dirt, waste materials, and rubbish caused by Contractor. Contractor shall remove all excess dirt, waste material, and rubbish caused by the Contractor; tools; equipment; machinery; and surplus materials from the Project site and surrounding area at the completion of the Work.

3.13.3 Personnel of Contractor and Subcontractors shall not occupy, live upon, or otherwise make use of the Project site during any time that Work is not being performed at the Project site, except as otherwise provided in the Contract Documents.

3.14 CUTTING, FITTING, AND PATCHING

3.14.1 Contractor shall do all cutting, fitting, or patching of the Work required to make all parts of the Work come together properly and to allow the Work to receive or be received by work of Separate Contractors shown upon, or reasonably implied by, the Contract Documents.

3.14.2 Contractor shall not endanger the Work, the Project, or adjacent property by cutting, digging, or otherwise. Contractor shall not cut or alter the work of any Separate Contractor without the prior consent of University's Representative.

3.15 ACCESS TO WORK

3.15.1 University, University's Representative, their consultants, and other persons authorized by University will at all times have access to the Work wherever it is in preparation or progress. Contractor shall provide safe and proper facilities for such access and for inspection.

3.16 ROYALTIES AND PATENTS

3.16.1 Contractor shall pay all royalties and license fees required for the performance of the Work. Contractor shall defend suits or claims resulting from Contractor's or any Subcontractor's infringement of patent rights and shall Indemnify, defend and hold harmless University and University's Representative from losses on account thereof.

3.17 DIFFERING SITE CONDITIONS

3.17.1 If Contractor encounters any of the following conditions at the site, Contractor shall immediately notify the University's Representative in writing of the specific differing conditions before they are disturbed and before any affected Work is performed, and permit investigation of the conditions:

- .1 Subsurface or latent physical conditions at the site (including Hazardous Materials) which differ materially from those indicated in this Contract, or if not indicated in this Contract, in the Information Available to Bidders; or
- .2 Unknown physical conditions at the site, of an unusual nature, which differ materially from those ordinarily encountered and generally recognized as inherent in work of the character provided for in the Contract.

3.17.2 Contractor shall be entitled to an adjustment to the Contract Sum and/or Contract Time as the result of extra costs and/or delays resulting from a materially differing site condition, if and only if Contractor fulfills the following conditions:

- .1 Contractor fully complies with Article 3.17.1; and
- .2 Contractor fully complies with Article 4 (including the timely filing of a Change Order Request and all other requirements for Change Orders Requests and Claims).

3.17.3 Adjustments to the Contract Sum and/or Contract Time shall be subject to the procedures and limitations set forth in Articles 7 and 8.

3.18 CONCEALED, UNFORESEEN, OR UNKNOWN CONDITIONS OR EVENTS

3.18.1 Except and only to the extent provided otherwise in Articles 3.17, 7 and 8 of the General Conditions, by signing the Agreement, Contractor agrees:

- .1 To bear the risk of concealed, unforeseen or unknown conditions or events, if any, which may be encountered in performing the Contract; and
- .2 That Contractor's bid for the Contract was made with full knowledge of this risk.

In agreeing to bear the risk of concealed, unforeseen or unknown conditions or events, Contractor understands that, except and only to the extent provided otherwise in Articles 3.17, 7 and 8, concealed, unforeseen or unknown conditions or events shall not excuse Contractor from its obligation to achieve Final Completion of the Work within the Contract Time, and shall not entitle the Contractor to an adjustment of the Contract Sum.

3.18.2 If Contractor encounters concealed, unforeseen or unknown conditions or events that may require a change to the design shown in the Contract Documents, Contractor shall immediately notify University's Representative in writing such that University's Representative can determine if a change to the design is

required. Contractor shall be liable to University for any extra costs incurred as the result of Contractor's failure to immediately give such notice.

3.18.3 If, as the result of concealed, unforeseen or unknown conditions or events, the University issues a Change Order or Field Order that changes the design from the design depicted in the Contract Documents, Contractor shall be entitled, subject to compliance all the provisions of the Contract, including those set forth in Articles 4, 7 and 8, to an adjustment of the Contract Sum and/or Contract Time, for the cost and delay resulting from implementing the changes to the design. Except as provided in this Article 3.18.3, or as may be expressly provided otherwise in the Contract, there shall be no adjustment of the Contract Sum and/or Contract Time as a result of concealed, unforeseen or unknown conditions or events. .

3.18.4 Contractor shall, as a condition precedent to any adjustment in Contract Sum or Contract Time under Article 3.18.3, fully comply with Article 4 (including the timely filing of a Change Order Request and all other requirements for Change Orders Requests and Claims).

3.19 HAZARDOUS MATERIALS

3.19.1 The University shall not be responsible for any Hazardous Material brought to the site by the Contractor.

3.19.2 If the Contractor: (i) introduces and/or discharges a Hazardous Material onto the site in a manner not specified by the Contract Documents; and/or (ii) disturbs a Hazardous Material identified in the Contract Documents, the Contractor shall hire a qualified remediation contractor at Contractor's sole cost to eliminate the condition as soon as possible. Under no circumstance shall the Contractor perform Work for which it is not qualified. University, in its sole discretion, may require the Contractor to retain at Contractor's cost an independent testing laboratory.

3.19.3 If the Contractor encounters a Hazardous Material which may cause foreseeable injury or damage, Contractor shall immediately: (i) secure or otherwise isolate such condition; (ii) stop all Work in connection with such material or substance (except in an emergency situation); and (iii) notify University (and promptly thereafter confirm such notice in writing)

3.19.4 Subject to Contractor's compliance with Article 3.19.3, the University shall verify the presence or absence of the Hazardous Material reported by the Contractor, except as qualified under Section 3.19.1 and 3.19.3, and, in the event such material or substance is found to be present, verify that the levels of the hazardous material are below OSHA Permissible Exposure Levels and below levels which would classify the material as a state of California or federal hazardous waste. When the material falls below such levels, Work in the affected area shall resume upon direction by the University. The Contract Time and Sum shall be extended appropriately as provided in Articles 7 and 8.

3.19.5 The University shall indemnify and hold harmless the Contractor from and against claims, damages, losses and expenses, arising from a Hazardous Material on the Project site, if such Hazardous Material: (i) was not shown on the Contract Documents or Information Available to Bidders; (ii) was not brought to the site by Contractor; and (iii) exceeded OSHA Permissible Exposure Levels or levels which would classify the material as a state of California or federal hazardous waste. The indemnity obligation in this Article shall not apply to:

- .1 Claims, damages, losses or expenses arising from the breach of contract, negligence or willful misconduct of Contractor, its suppliers, its Subcontractors of all tiers and/or any persons or entities working under Contractor; and
- .2 Claims, damages, losses or expenses arising from a Hazardous Material subject to Article 3.19.2.

3.19.6 In addition to the requirements in Article 3.22, Contractor shall indemnify and hold harmless the

University from and against claims, damages, losses and expenses, arising from a Hazardous Material on the Project site, if such Hazardous Material: (i) was shown on the Contract Documents or Information Available to Bidders; (ii) was brought to the site by Contractor; and (iii) exceeded OSHA Permissible Exposure Levels or levels which would classify the material as a state of California or federal hazardous waste. Nothing in this paragraph shall obligate the Contractor to indemnify University in the event of the sole negligence of the University, its officers, agents, or employees.

3.20 INFORMATION AVAILABLE TO BIDDERS

3.20.1 Any information provided pursuant to INFORMATION AVAILABLE TO BIDDERS is subject to the following provisions:

- .1 The information is made available for the convenience of Bidders and is not a part of the Contract.
- .2 The Contractor may rely on written descriptions of physical conditions included in the information to the extent such reliance is reasonable.
- .3 Other components of the information, including but not limited to recommendations, may not be relied upon by Contractor. University shall not be responsible for any interpretation of or conclusion drawn from the other components of the information by the Contractor.

3.21 LIABILITY FOR AND REPAIR OF DAMAGED WORK

3.21.1 Contractor shall be liable for any and all damages and losses to the Project (whether by fire, theft, vandalism, earthquake, flood or otherwise) prior to University's acceptance of the Project as fully completed except that Contractor shall not be liable for damages and losses to the Project caused by earthquake in excess of magnitude 3.5 on the Richter Scale, tidal wave, or flood, provided that the damages or losses were not caused in whole or in part by the negligent acts or omissions of Contractor, its officers, agents or employees (including all Subcontractors and suppliers of all tiers). As used herein, "flood" shall have the same meaning as in the builder's risk property insurance.

3.21.2 Contractor shall promptly repair and replace any Work or materials damaged or destroyed for which the Contractor is liable under Article 3.21.1.

3.22 INDEMNIFICATION

3.22.1 Contractor shall indemnify, defend and hold harmless University, University's consultants, University's Representative, University's Representative's consultants, and their respective directors, officers, agents, and employees from and against losses (including without limitation the cost of repairing defective work and remedying the consequences of defective work) arising out of, resulting from, or relating to the following:

- .1 The failure of Contractor to perform its obligations under the Contract.
- .2 The inaccuracy of any representation or warranty by Contractor given in accordance with or contained in the Contract Documents.
- .3 Any claim of damage or loss by any Subcontractor against University arising out of any alleged act or omission of Contractor or any other Subcontractor, or anyone directly or indirectly employed by Contractor or any Subcontractor.
- .4 Any claim of damage or loss resulting from Hazardous Materials introduced, discharged, or disturbed by Contractor as required per Article 3.19.6.

3.22.2 The University shall not be liable or responsible for any accidents, loss, injury (including death) or damages happening or accruing during the term of the performance of the Work herein referred to or in connection therewith, to persons and/or property, and Contractor shall fully indemnify, defend and hold harmless University and protect University from and against the same as provided in paragraph 3.22.1

above. In addition to the liability imposed by law upon the Contractor for damage or injury (including death) to persons or property by reason of the negligence of the Contractor, its officers, agents, employees or Subcontractors, which liability is not impaired or otherwise affected hereby, the Contractor shall defend, indemnify, hold harmless, release and forever discharge the University, its officers, employees, and agents from and against and waive any and all responsibility of same for every expense, liability, or payment by reason of any damage or injury (including death) to persons or property suffered or claimed to have been suffered through any negligent act, omission, or willful misconduct of the Contractor, its officers, agents,

employees, or any of its Subcontractors, or anyone directly or indirectly employed by either of them or from the condition of the premises or any part of the premises while in control of the Contractor, its officers, agents, employees, or any of its Subcontractors or anyone directly or indirectly employed by either of them, arising out of the performance of the Work called for by this Contract. Contractor agrees that this indemnity and hold harmless shall apply even in the event of negligence of University, its officers, agents, or employees, regardless of whether such negligence is contributory to any claim, demand, loss, damage, injury, expense, and/or liability; but such indemnity and hold harmless shall not apply (i) in the event of the sole negligence of University, its officers, agents, or employees; or (ii) to the extent that the University shall indemnify and hold harmless the Contractor for Hazardous Materials pursuant to Article 3.19.5 .

3.22.3 In claims against any person or entity indemnified under this Article 3.22 that are made by an employee of Contractor or any Subcontractor, a person indirectly employed by Contractor or any Subcontractor, or anyone for whose acts Contractor or any Subcontractor may be liable, the indemnification obligation under this Article 3.22 shall not be limited by any limitation on amount or type of damages, compensation, or benefits payable by or for Contractor or any Subcontractor under workers' compensation acts, disability benefit acts, or other employee benefit acts.

3.22.4 The indemnification obligations under this Article 3.22 shall not be limited by any assertion or finding that the person or entity indemnified is liable by reason of a non-delegable duty.

3.22.5 Contractor shall indemnify University from and against Losses resulting from any claim of damage made by any Separate Contractor against University arising out of any alleged acts or omissions of Contractor, any Subcontractor, anyone directly or indirectly employed by either of them, or anyone for whose acts either of them may be liable.

3.22.6 Contractor shall indemnify Separate Contractors from and against Losses arising out of the negligent acts, omissions, or willful misconduct of Contractor, any Subcontractor, anyone directly or indirectly employed by either of them, or anyone for whose acts either of them may be liable.

ARTICLE 4 ADMINISTRATION OF THE CONTRACT

4.1 ADMINISTRATION OF THE CONTRACT BY UNIVERSITY'S REPRESENTATIVE

4.1.1 University's Representative will provide administration of the Contract as provided in the Contract Documents and will be the representative of University. University's Representative will have authority to act on behalf of University only to the extent provided in the Contract Documents.

4.1.2 University's Representative will have the right to visit the Project site at such intervals as deemed appropriate by the University's Representative. However, no actions taken during such Project site visit by University's Representative shall relieve Contractor of its obligations as described in the Contract Documents.

4.1.3 University's Representative will not have control over, will not be in charge of, and will not be responsible for construction means, methods, techniques, sequences, or procedures, or for safety precautions and programs in connection with the Work, since these are solely Contractor's responsibility.

4.1.4 Except as otherwise provided in the Contract Documents or when direct communications have been specifically authorized, University and Contractor shall communicate through University's Representative. Except when direct communication has been specifically authorized in writing by University Representative, communications by Contractor with University's consultants and University's Representative's consultants shall be through University's Representative. Communications by University and University's Representative with Subcontractors will be through Contractor. Communications by Contractor and Subcontractors with Separate Contractors shall be through University's Representative. Contractor shall not rely on oral or other non-written communications.

4.1.5 Based on University's Representative's Project site visits and evaluations of Contractor's Applications For Payment, University's Representative will recommend amounts, if any, due Contractor and will issue Certificates For Payment in such amounts.

4.1.6 University's Representative will have the authority to reject the Work, or any portion thereof, which does not conform to the Contract Documents. University's Representative will have the authority to stop the Work or any portion thereof. Whenever University's Representative considers it necessary or advisable for implementation of the intent of the Contract Documents, University's Representative will have the authority to require additional inspection or testing of the Work in accordance with the Contract Documents, whether or not such Work is fabricated, installed, or completed. However, no authority of University's Representative conferred by the Contract Documents nor any decision made in good faith either to exercise or not exercise such authority, will give rise to a duty or responsibility of University or University's Representative to Contractor, or any person or entity claiming under or through Contractor.

4.1.7 University's Representative will have the authority to conduct inspections as provided in the Contract Documents, to take Beneficial Occupancy and to determine the dates of Substantial Completion and Final Completion; will receive for review and approval any records, written warranties, and related documents required by the Contract Documents and assembled by Contractor; and will issue a final Certificate For Payment upon Contractor's compliance with the requirements of the Contract Documents.

4.1.8 University's Representative will be, in the first instance, the interpreter of the requirements of the Contract Documents and the judge of performance thereunder by Contractor. Should Contractor discover any conflicts, omissions, or errors in the Contract Documents; have any questions about the interpretation or clarification of the Contract Documents; question whether Work is within the scope of the Contract Documents; or question that Work required is not sufficiently detailed or explained, then, before proceeding with the Work affected, Contractor shall notify University's Representative in writing and request interpretation, clarification, or furnishing of additional detailed instructions. University's Representative's response to questions and requests for interpretations, clarifications, instructions, or decisions will be made with reasonable promptness. Should Contractor proceed with the Work affected before receipt of a response from University's Representative, any portion of the Work which is not done in accordance with University's Representative's interpretations, clarifications, instructions, or decisions shall be removed or replaced and Contractor shall be responsible for all resultant losses.

4.2 CONTRACTOR CHANGE ORDER REQUESTS

4.2.1 Contractor may request changes to the Contract Sum and/or Contract Time for Extra Work, materially differing site conditions, or Delays to Final Completion of the Work.

4.2.2 Conditions precedent to obtaining an adjustment of the Contract Sum and/or Contract Time , payment of money, or other relief with respect to the Contract Documents, for any other reason, are:

- .1 Timely submission of a Change Order Request that meets the requirements of Articles 4.2.3.1 and 4.2.3.2; and
- .2 If requested, timely submission of additional informational requested by the University

Representative pursuant to Article 4.2.3.3.

4.2.3 Change Order Request:

4.2.3.1 A Change Order Request will be deemed timely submitted if, and only if, it is submitted within 7 days of the date the Contractor discovers, or reasonably should discover the circumstances giving rise to the Change Order Request, unless additional time is allowed in writing by University's Representative for submission of the Change Order Request, provided that if :

- .1 the Change Order Request includes compensation sought by a Subcontractor; AND
- .2 the Contractor requests in writing to the University's Representative, within the 7-day time period, additional time to permit Contractor to conduct an appropriate review of the Subcontractor Change Order Request, the time period for submission of the actual Change Order Request shall be extended by the number of days specified in writing by the University's Representative.

4.2.3.2 A Change Order Request must state that it is a Change Order Request, state and justify the reason for the request, and specify the amount of any requested adjustment of the Contract Sum, Contract Time, and/or other monetary relief. If the Contractor requests an adjustment to the Contract Sum or other monetary relief, the Contractor shall submit the following with the Change Order Request:

- .1 a completed Cost Proposal in the form contained in the Exhibits meeting the requirements of Article 7; OR
- .2 a partial Cost Proposal and a declaration of what required information is not then known to Contractor. If Contractor failed to submit a completed Cost Proposal with the Change Order Request, Contractor shall submit a completed Cost Proposal meeting the requirements of Article 7 within 7 days of the date the Contractor submitted the Change Order Request unless additional time is allowed by the University's Representative.

4.2.3.3 Upon request of University's Representative, Contractor shall submit such additional information as may be requested by University's Representative for the purpose of evaluating the Change Order Request. Such additional information may include:

- .1 If Contractor seeks an adjustment of the Contract Sum or other monetary relief, actual cost records for any changed or extra costs (including without limitation, payroll records, material and rental invoices and the like), shall be submitted by the deadline established by the University's Representative, who may require such actual cost records to be submitted and reviewed, on a daily basis, by the University's Representative and/or representatives of the University's Representative.
- .2 If Contractor seeks an adjustment of the Contract Time, written documentation demonstrating Contractor's entitlement to a time extension under Article 8.4, which shall be submitted within 15 days of the date requested. If requested, Contractor may submit a fragnet in support of its request for a time extension. The University may, but is not obligated to, grant a time extension on the basis of a fragnet alone which, by its nature, is not a complete schedule analysis. If deemed appropriate by University Representative, Contractor shall submit a more detailed schedule analysis in support of its request for a time extension.
- .3 If Contractor seeks an adjustment of the Contract Sum or other monetary relief for delay, written documentation demonstrating Contractor's entitlement to such an adjustment under Article 7.3.9, which shall be submitted within 15 days of the date requested.

- .4 Any other information requested by the University's Representative for the purpose of evaluating the Change Order Request, which shall be submitted by the deadline established by the University's Representative.

4.2.4 University's Representative will make a decision on a Change Order Request, within a reasonable time, after receipt of a Change Order Request. In the event the Change Order Request is submitted pursuant to Article 8.4.1, the University's Representative shall promptly review and accept or reject it within thirty

(30) days. A final decision is any decision on a Change Order Request which states that it is final. If University's Representative issues a final decision denying a Change Order Request in whole or in part, Contractor may contest the decision by filing a timely Claim under the procedures specified in Article 4.3.

4.2.5 Contractor may file a written demand for a final decision by University's Representative on all or part of any Change Order Request as to which the University's Representative has not previously issued a final decision pursuant to Article 4.2.4; such written demand may not be made earlier than the 30th day after submission of the Change Order Request. Within 30 days of receipt of the demand, University's Representative will issue a final decision on the Change Order Request. The University's Representative's failure to issue a decision within the 30-day period shall be treated as the issuance, on the last day of the 30-day period, of a final decision to deny the Change Order Request in its entirety.

4.3 CLAIMS

4.3.1 The term "Claim" means a written demand or assertion by Contractor seeking an adjustment or interpretation of the terms of the Contract Documents, payment of money, extension of time, or other relief with respect to the Contract Documents, including a determination of disputes or matters in question between University and Contractor arising out of or related to the Contract Documents or the performance of the Work. However, the term "Claim" shall not include, and the Claims procedures provided under this Article 4, including but not limited to arbitration, shall not apply to the following:

- .1 Claims respecting penalties for forfeitures prescribed by statute or regulation which a government agency is specifically authorized to administer, settle, or determine.
- .2 Claims respecting personal injury, death, reimbursement, or other compensation arising out of or resulting from liability for personal injury or death.
- .3 Claims by University, except as set forth in Article 4.7.4.
- .4 Claims respecting stop notices.

4.3.2 A Claim arises upon the issuance of a written final decision denying in whole or in part Contractor's Change Order Request pursuant to Article 4.2.4.

4.3.3 A Claim must include the following:

- .1 A statement that it is a Claim and a request for a decision pursuant to Article 4.5.
- .2 A detailed factual narrative of events fully describing the nature and circumstances giving rise to the Claim, including but not limited to, necessary dates, locations, and items of work affected.
- .3 A certification, executed by Contractor, that the claim is filed in good faith. The certification must be made on the Claim Certification form, included in the Exhibits to the Contract. The language of the Claim Certification form may not be modified.
- .4 A certification, executed by each Subcontractor claiming not less than 5% of the total monetary amount sought by the claim, that the subcontractor's portion of the claim is filed in good faith. The certification must be made on the Claim Certification form, included in the Exhibits to the Contract. The language of the

Claim Certification form may not be modified.

- .5 A statement demonstrating that a Change Order Request was timely submitted as required by Article 4.2.3
- .6 If a Cost Proposal or declaration was required by Article 4.2.3, a statement demonstrating that the Cost Proposal or the declaration was timely submitted as required by Article 4.2.3.
- .7 A detailed justification for any remedy or relief sought by the Claim, including to the extent applicable, the following:
 - .1 If the Claim involves Extra Work, a detailed cost breakdown of the amounts claimed, including the items specified in Article 7.3.2. An estimate of the costs must be provided even if the costs claimed have not been incurred when the Claim is submitted. To the extent costs have been incurred when the Claim is submitted, the Claim must include actual cost records (including without limitation, payroll records, material and rental invoices and the like) demonstrating that costs claimed have actually been incurred. To the extent costs have not yet been incurred at the time the Claim is submitted, actual cost records must be submitted on a current basis not less than once a month during any periods costs are incurred. A cost record will be considered current if submitted within 30 days of the date the cost reflected in the record is incurred. At the request of the University's Representative, claimed extra costs may be subject to further verification procedures (such as having an inspector verify the performance of alleged Extra Work on a daily basis). The cost breakdown must include an itemization of costs for i) labor including names, classifications, regular hours and overtime hours worked, dates worked, and other pertinent information; ii) materials stored or incorporated in the work including invoices, purchase orders, location of materials either stored or incorporated into the work, dates materials were transported to the project or incorporated into the work, and other pertinent information; and iii) itemization of machinery and equipment including make, model, hours of use, dates of use and equipment rental rates of any rented equipment.
 - .2 If the Claim involves an extension of the Contract Time, written documentation demonstrating the Contractor's entitlement to a time extension under Article 8.4, including the specific dates for which a time extension is sought and the specific reasons for entitlement of a time extension.
 - .3 If the Claim involves an adjustment of the Contract Sum for delay, written documentation demonstrating the Contractor's entitlement to such an adjustment under Article 7.3.9, including but not limited to, a detailed time impact analysis of the Contract Schedule. The Contract Schedule must demonstrate Contractor's entitlement to such an adjustment under Article 7.3.9.

4.4 ASSERTION OF CLAIMS

4.4.1 Claims by Contractor shall be first submitted to University's Representative for decision.

4.4.2 Notwithstanding the making of any Claim or the existence of any dispute regarding any Claim, unless otherwise directed by University's Representative, Contractor shall not cause any delay, cessation, or termination in or of Contractor's performance of the Work, but shall diligently proceed with performance of the Work in accordance with the Contract Documents.

4.4.3 Contractor shall submit a Claim in writing, together with all supporting data specified in Article 4.3.3, to University's Representative as soon as possible but not later than 30 days after the date the Claim arises under Article 4.3.2, provided that after written notification to the University's Representative within such time period, the time period for submission of the Claim shall be extended by the number of days specified in writing by the University's Representative where the Claim includes compensation sought by a Subcontractor and the Contractor requests an extension of time to permit it to discharge its responsibilities to conduct an appropriate review of the Subcontractor claim.

4.4.4 Strict compliance with the requirements of Articles 4.2, 4.3 and 4.4 are conditions precedent to Contractor's right to arbitrate or litigate a Claim. Contractor specifically agrees to assert no Claims in arbitration or litigation unless there has been strict compliance with Articles 4.2, 4.3, and 4.4. The failure of Contractor to strictly comply with the requirements of Articles 4.2, 4.3 and 4.4 constitutes a failure by Contractor to exhaust its administrative remedies with the University, thereby denying any court or arbitration panel of jurisdiction to adjudicate the Claim.

4.5 DECISION OF UNIVERSITY'S REPRESENTATIVE ON CLAIMS

4.5.1 University's Representative will timely review Claims submitted by Contractor. If University's Representative determines that additional supporting data are necessary to fully evaluate a Claim, University's Representative will request such additional supporting data in writing. Such data shall be furnished no later than 10 days after the date of such request. University's Representative will render a decision promptly and in any case within 30 days after the later of the receipt of the Claim or the deadline for furnishing such additional supporting data; provided that, if the amount of the Claim is in excess of \$50,000, the aforesaid 30-day period shall be 60 days. Failure of University's Representative to render a decision by the applicable deadline will be deemed a decision denying the Claim on the date of the deadline. The decision of University's Representative will be final and binding unless appealed in accordance with Articles 4.5.2, 4.5.3, and 4.5.4. The University's Representative's decision on a Claim or dispute will include a statement substantially as follows:

“This is a decision under Article 4.5 of the General Conditions of your contract. If you are dissatisfied with the decision, and if you complied with the procedural requirements for asserting claims specified in Article 4 of the General Conditions of your contract, you may have the right to arbitrate or litigate this decision. If you fail to take appropriate action within 30 days of the date of this decision, the decision shall become final and binding and not subject to further appeal.”

4.5.2 If either Contractor or University disputes University's Representative's decision on a Claim, such party (the "Disputing Party") must either provide a written notice of its election to arbitrate or provide written notice of its election to litigate the Claim within 30 days after the decision of University's Representative or, if no decision has been issued, within 30 days from the date of the applicable deadline in Article 4.5.1 for University Representative to render a decision.

4.5.3 If a notice of election to arbitrate or litigate is not given by either party within 30 days after the decision of University's Representative, University's Representative's decision on the Claim will be final and binding and not subject to appeal or challenge.

4.5.4 If the Disputing Party gives timely notice of its election to arbitrate the University's Representative's decision on a Claim, Disputing Party shall have the right, within 120 days after a Notice of Completion, or a Notice of Cessation, as applicable, is filed for the Contract, to make a demand for arbitration in accordance with Article 4.7. Failure to perfect a Claim for which a timely election to arbitrate has been made by the timely filing of a demand for arbitration and timely payment of all applicable and required fees to AAA shall result in the University's Representative's decision on said Claim becoming final and binding and not subject to appeal or challenge. If the Disputing Party makes a timely demand for arbitration, and the amount of the Claim in question, when combined with all other Claims, if any, which are the subject of

previously filed demands for arbitration that have not been resolved by settlement or arbitration award, is \$100,000 or more, then the other party may elect to litigate all such Claims by filing a written notice with the American Arbitration Association ("AAA") within 30 days after its receipt of notice from AAA of the Disputing Party's demand for arbitration of the Claim that raises the total amount of Claims subject to arbitration to \$100,000 or more. If the other party fails to give notice of its election to litigate within such 30-day period, it shall be deemed to have consented to arbitration and waived the right to litigate. If after commencement of arbitration the amount of unresolved Claims in arbitration are allowed to be increased to \$100,000 or more, through an AAA-allowed amendment or otherwise, either party may elect to litigate within 30 days following the date that the electing party first receives written notification from AAA that total Claims in arbitration equal or exceed \$100,000. If neither party gives notice of its election to litigate within such 30-day period as applicable, then both parties shall be deemed to have consented to arbitration and waived the right to litigate.

4.5.5 Any litigation shall be filed in the Superior Court of the State of California for the County in which the contract was to be performed.

4.5.6 The parties will attempt in good faith to resolve any controversy or Claim arising out of or relating to this Contract by negotiation.

4.6 MEDIATION

4.6.1 The parties may agree to mediate any controversy or Claim arising out of or relating to this Contract.

4.7 ARBITRATION

4.7.1 A demand for arbitration pursuant to Article 4.5 shall include a copy of the Claim presented to University's Representative pursuant to Article 4.4 and a copy of the decision of University's Representative pursuant to Article 4.5, if any. The demand shall state the amount in controversy, if any, and state the remedy sought. The demand shall identify the University's Responsible Administrator as the representative of the responding party and the Office of the General Counsel as counsel for the responding party. The demand shall be filed with the AAA and shall not be deemed to have been made until all applicable fees have been paid to the AAA by the demanding party. Copies of the demand and attachments shall be sent to University's Responsible Administrator as the representative of the responding party and the University's Office of General Counsel as attorney for the responding party, at the addresses set forth in the Project Directory, at the time the demand for arbitration is initiated with the AAA.

4.7.2 Except as modified by this Article 4.7, arbitration shall be initiated and conducted in accordance with the Construction Industry Arbitration Rules of the AAA then in effect. The following additional modifications shall be made to the aforesaid AAA rules:

- .1 Civil discovery shall be permitted for the production of documents and taking of depositions. Other discovery may be permitted in the discretion of the arbitrator. All disputes regarding discovery shall be decided by the arbitrator.
- .2 University's Representative and/or University's consultants, shall if required by agreement with University, upon demand by University join in and be bound by the Arbitration. University's Representative and University's consultants will have the same rights in any arbitration proceeding as are afforded by the AAA rules to Contractor and University.
- .3 Contractor's sureties shall be bound by any arbitration award and may join in any arbitration proceeding.
- .4 Except as provided in Articles 4.7.2.2. and 4.7.2.3 above, no Subcontractor or other person shall have a right or obligation to join in or be a party to any arbitration proceeding provided for in this Article 4 either directly, by joinder, by consolidation or actions, by counterclaim or crossclaim, or otherwise without

- the express written consent of University, Contractor, and the joining party.
- .5 If more than one demand for arbitration is made by a party with respect to Claims referred to University's Representative, all such Claims shall be consolidated into a single arbitration unless the parties otherwise agree in writing.
 - .6 If total Claims are less than \$50,000, AAA expedited procedures as modified by this Article 4 shall apply. If total Claims are between \$50,000 and \$100,000 they shall be heard by a single arbitrator who shall be an attorney. If total Claims are in excess of \$100,000 and are submitted to arbitration, either by agreement or by failure to elect litigation the controversy shall be heard by a panel of three arbitrators, one of which shall be an attorney.
 - .7 No arbitrator shall be appointed and no discovery may be commenced prior to the date of Final Completion unless University and Contractor otherwise agree.
 - .8 The exclusive forum for determining arbitrability shall be the Superior Court of the State of California. AAA shall not submit to any arbitrator any matter concerning the arbitrability of the dispute if the arbitrability is contested.
 - 9 If the expedited procedures of the AAA are applicable, the AAA shall submit simultaneously to each party an identical list of 7 proposed arbitrators drawn from the National Panel of Commercial Arbitrators, and each party may strike 3 names from the list on a peremptory basis and return the list to AAA within 10 days from the date of receipt.
 - .10 Except as provided herein, the arbitration shall be conducted and enforced under California law, including the California Arbitration Act (California Code of Civil Procedure section 1280 and following). The Federal Arbitration Act shall not apply to the arbitration.

4.7.3 Unless University and Contractor otherwise agree in writing, the arbitration decision shall be binding upon the parties, made under and in accordance with the laws of the State of California, supported by substantial evidence, and in writing. If the total of all Claims or cross Claims submitted to arbitration is in excess of \$50,000, the award shall contain the basis for the decision, findings of fact, and conclusions of law. Any arbitration award shall be subject to confirmation, vacation, or correction under the procedures and on the grounds specified in the California Code of Civil Procedure including without limitation Section 1296. The expenses and fees of the arbitrators and the administrative fees of the AAA shall be divided among the parties equally. Each party shall pay its own counsel fees, witness fees, and other expenses incurred for its own benefit.

4.7.4 University may, but is not required, to assert as a counterclaim any matter arising out of the claims asserted by Contractor in the arbitration. University's failure to assert any such counterclaim in an arbitration shall be without prejudice to the University's right to assert the counterclaim in litigation or other proceeding.

4.8 WAIVER

4.8.1 A waiver of or failure by University or University's Representative to enforce any requirement in this Article 4, including without limitation the requirements in Articles 4.2, 4.3, 4.4, and 4.5 in connection with any Claim shall not constitute a waiver of, and shall not preclude the University or University's Representative from enforcing such requirements in connection with any other Claims.

4.8.2 The Contractor agrees and understands that no oral approval, either express or implied, of any Claim shall be binding upon University unless and until such approval is ratified by execution of a written Change Order.

**ARTICLE 5
SUBCONTRACTORS**

5.1 AWARD OF SUBCONTRACTS AND OTHER CONTRACTS FOR PORTIONS OF THE WORK

5.1.1 Unless otherwise stated in the Contract Documents, Contractor shall submit in writing, prior to entering into subcontract agreements, the names and addresses of all Subcontractors proposed for the Work that were not previously listed in Contractor's Bid.

5.1.2 Any Subcontractor may be disqualified if University or University's Representative determines that such Subcontractor fails to meet the requirements of the Contract Documents or for any other reason.

5.1.3 In accordance with the Subletting and Subcontracting Fair Practices Act, nothing herein shall be deemed to entitle Contractor, without the approval of University, to substitute other subcontractors for those named in Contractor's List of Subcontractors and List of Changes in Subcontractors Due to Alternates contained in the completed Bid Form; and, except with such approval, no such substitution shall be made.

5.1.4 Except as hereinafter provided, any increase in the cost of the Work resulting from the replacement or substitution of a Subcontractor, as required by University or University's Representative pursuant to Article 5.1.1 shall be borne solely by Contractor and Contractor shall not be entitled to any increase in Contract Sum or extension of Contract Time on account of such replacement or substitution.

5.2 SUBCONTRACTUAL RELATIONS

5.2.1 Any part of the Work performed for Contractor by a first-tier Subcontractor shall be pursuant to a written subcontract. Each such subcontract shall require the Subcontractor, to the extent of the Work to be performed by the Subcontractor, to be bound to Contractor by the terms of the Contract Documents, to assume toward Contractor all the obligations and responsibilities which Contractor assumes towards University by the Contract Documents, and to perform such portion of the Work in accordance with the Contract Documents. Each such subcontract shall preserve and protect the rights of University under the Contract Documents, with respect to the Work to be performed by Subcontractor, so that subcontracting thereof will not prejudice such rights. Contractor shall cause each such subcontract to expressly include the following requirements:

- .1 Subcontractor waives all rights that Subcontractor may have against University for damages caused by fire or other perils covered by builder's risk property insurance carried by Contractor or University, except for such rights Subcontractor may have to the proceeds of such insurance held by University under Article 11.
- .2 University and entities and agencies designated by University will have access to and the right to audit and the right to copy at University's cost all of Subcontractor's books, records, contracts, correspondence, instructions, drawings, receipts, vouchers, purchase orders, and memoranda relating to the Work. Subcontractor shall preserve all such records and other items for a period of at least 3 years after Final Completion.
- .3 Subcontractor recognizes the rights of University under Article 5.3, Contingent Assignment of Subcontracts, and agrees, upon notice from University that University has elected to accept said assignment and to retain Subcontractor pursuant to the terms of the subcontract, to complete the unperformed obligations under the subcontract and, if requested by University, to execute a written agreement confirming that Subcontractor is bound to University under the terms of the subcontract.

5.2.2 Upon the request of University, Contractor shall promptly furnish to University a true, complete, and executed copy of any subcontract.

5.2.3 Nothing contained in the Contract Documents shall create any contractual relationship between any Subcontractor and University, except when, and only to the extent that, University elects to accept the assignment of the subcontract with such Subcontractor pursuant to Article 5.3, Contingent Assignment of Subcontracts.

5.3 CONTINGENT ASSIGNMENT OF SUBCONTRACTS

5.3.1 Contractor hereby assigns to University all its interest in first-tier subcontracts now or hereafter entered into by Contractor for performance of any part of the Work. The assignment will be effective upon acceptance by University in writing and only as to those subcontracts which University designates in writing. University may accept said assignment at any time during the course of the Work and prior to Final Completion in the event of a suspension or termination of Contractor's rights under the Contract Documents. Such assignment is part of the consideration to University for entering into the Contract with Contractor and may not be withdrawn prior to Final Completion.

ARTICLE 6 CONSTRUCTION BY UNIVERSITY OR BY SEPARATE CONTRACTORS

6.1 UNIVERSITY'S RIGHT TO PERFORM CONSTRUCTION AND TO AWARD SEPARATE CONTRACTS

6.1.1 University reserves the right to award separate contracts for, or to perform with its own forces, construction or operations related to the Work or other construction or operations at or affecting the Project site, including portions of the Work which have been deleted by Change Order. Contractor shall cooperate with University's forces and Separate Contractors.

6.1.2 University will provide coordination of the activities of University's forces and of each Separate Contractor with the Work of Contractor. Contractor shall participate with University and Separate Contractors in joint review of construction schedules and Project requirements when directed to do so. Contractor shall make necessary revisions to the Contract Schedule after such joint review.

6.2 MUTUAL RESPONSIBILITY

6.2.1 Contractor shall afford University and Separate Contractors reasonable opportunity for introduction and storage of their materials and equipment and performance of their activities. Contractor shall connect, schedule, and coordinate its construction and operations with the construction and operations of University and Separate Contractors as required by the Contract Documents.

6.2.2 If a portion of the Work is dependent upon the proper execution or results of other construction or operations by University or Separate Contractors, Contractor shall inspect such other construction or operations before proceeding with that portion of the Work. Contractor shall promptly report to University's Representative apparent discrepancies or defects which render the other construction or operations unsuitable to receive the Work. Unless otherwise directed by University's Representative, Contractor shall not proceed with the portion of the Work affected until apparent discrepancies or defects have been corrected. Failure of Contractor to so report within a reasonable time after discovering such discrepancies or defects shall constitute an acknowledgment that the other construction or operations by University or Separate Contractors is suitable to receive the Work, except as to defects not then reasonably discoverable.

6.3 UNIVERSITY'S RIGHT TO CLEAN UP

6.3.1 If a dispute arises between Contractor and Separate Contractors as to the responsibility under their respective contracts for maintaining the Project site and surrounding areas free from waste materials and

rubbish, University may clean up and allocate the cost between those firms it deems to be responsible.

ARTICLE 7 CHANGES IN THE WORK

7.1 CHANGES

7.1.1 University may, from time to time, order or authorize additions, deletions, and other changes in the Work by Change Order or Field Order without invalidating the Contract and without notice to sureties. Absence of such notice shall not relieve such sureties of any of their obligations to University.

7.1.2 Contractor may request a Change Order under the procedures specified in Article 4.2.

7.1.3 A Field Order may be issued by University, does not require the agreement of Contractor, and shall be valid with or without the signature of Contractor.

7.1.4 Contractor shall proceed promptly with any changes in the Work, unless otherwise provided in the relevant Change Order or Field Order.

7.2 DEFINITIONS

7.2.1 A Change Order is a Contract Document (as shown in the Exhibits) which has been signed by both University and Contractor, and states their agreement, as applicable, to the following:

- .1 A change in the Work, if any.
- .2 The amount of an adjustment of the Contract Sum, if any.
- .3 The amount of an adjustment of the Contract Time, if any.
- .4 A modification to any other Contract term or condition.

7.2.2 A Unilateral Change Order may be issued by University, without the Contractor' signature, where the University determines that a change in the Work requires an adjustment of the Contract Sum or Contract Time, even though no agreement has been reached between University and Contractor with regard to such change in the Work.

7.2.3 A Field Order (as shown in the Exhibits) is a Contract Document issued by the University that orders the Contractor to perform Work. A Field Order may, but need not, constitute a change in the Work and may, but need not, entitle Contractor to an adjustment of the Contract Sum or Contract Time.

7.3 CHANGE ORDER PROCEDURES

7.3.1 Contractor shall provide a Change Order Request and Cost Proposal pursuant to Article 4.2 and this Article 7.3 of the General Conditions. Adjustments of the Contract Sum resulting from Extra Work and Deductive Work shall be determined using one of the methods described in this Article 7.3. Adjustments of the Contract Time shall be subject to the provisions in Article 8. Contractor's obligation to provide Cost Proposals shall be subject to the following:

- .1 The obligation of Contractor to provide Cost Proposals is not Extra Work, and shall not entitle the Contractor to an adjustment of the Contract Sum or Contract Time.
- .2 The failure of Contractor to timely provide a Cost Proposal pursuant to Article 4.2 and this Article 7.3.1 is a material breach of the Contract. Contractor shall be responsible for any delay in implementing a change for which Contractor failed to timely provide a Cost Proposal consistent with the requirements of Article 4.2 and this Article 7.3.1.

7.3.2 The term "Cost of Extra Work" as used in this Article 7.3 shall mean actual costs incurred or to be incurred by Contractor and each Subcontractor regardless of tier involved, to the extent not otherwise disallowed under Article 7.3.3, and shall be limited to the following (to the extent the Contractor

demonstrates that the costs are both reasonable and actually incurred, if such costs have been incurred):

- .1 Straight-time wages or salaries for employees employed at the Project site, or at fabrication sites off the Project site, incurred as a result of the performance of the Extra Work.
- .2 Fringe Benefits and Payroll Taxes for employees employed at the Project site, or at fabrication sites off the Project site, incurred as a result of the performance of the Extra Work.
- .3 Overtime wages or salaries, specifically authorized in writing by University's Representative, for employees employed at the Project site, or at fabrication sites off the Project site, incurred as a result of the performance of the Extra Work.
- .4 Fringe Benefits and Payroll Taxes for overtime Work specifically authorized in writing by University's Representative, for employees employed at the Project site, or at fabrication sites off the Project site, incurred as a result of the performance of the Extra Work.
- .5 Costs of materials and consumable items which are furnished and incorporated into the Extra Work, as approved by University's Representative. Such costs shall be charged at the lowest price available to the Contractor but in no event shall such costs exceed competitive costs obtainable from other subcontractors, suppliers, manufacturers, and distributors in the area of the Project site. All discounts, rebates, and refunds and all returns from sale of surplus materials and consumable items shall accrue to University and Contractor shall make provisions so that they may be obtained.
- .6 Sales taxes on the costs of materials and consumable items which are incorporated into and used in the performance of the Extra Work pursuant to Article 7.3.2.5 above.
- .7 Rental charges for necessary machinery and equipment, whether owned or hired, as authorized in writing by University's Representative, exclusive of hand tools, used directly in the performance of the Extra Work. Such rental charges shall not exceed the current Equipment Rental Rates published by the California Department of Transportation for the area in which the work is performed. Such rental rates are found at <http://www.dot.ca.gov/hq/construc/equipmnt.html> . Contractor shall attach a copy of said schedule to the Cost Proposal. The charges for any machinery and equipment shall cease when the use thereof is no longer necessary for the Extra Work.
- .8 Additional costs of royalties and permits due to the performance of the Extra Work.
- .9 The cost for Insurance and Bonds shall not exceed 2% of items .1 through .8 above.

University and Contractor may agree upon rates to be charged for any of the items listed in this Article 7.3.2. Such agreed upon rates shall be subject to audit pursuant to Article 15.7. Contractor shall promptly refund to University any amounts (including associated mark-ups) in excess of the actual costs of such items.

7.3.3 Cost of Extra Work shall not include any of the following:

- .1 Supervision
- .2 Superintendent(s).
- .3 Assistant Superintendent(s).
- .4 Project Engineer(s).
- .5 Project Manager(s).

- .6 Scheduler(s).
- .7 Estimator(s).
- .8 Small tools (Replacement value does not exceed \$300).
- .9 Office expenses including staff, materials and supplies.
- .10 On-site or off-site trailer and storage rental and expenses.
- .11 Site fencing.
- .12 Utilities including gas, electric, sewer, water, telephone, facsimile, copier equipment.
- .13 Data processing personnel and equipment.
- .14 Federal, state, or local business income and franchise taxes.
- .15 Overhead and Profit.
- .16 Costs and expenses of any kind or item not specifically and expressly included in Article 7.3.2.

7.3.4 The term "Contractor Fee" shall mean the full amount of compensation, both direct and indirect (including without limitation all overhead and profit), to be paid to Contractor for its own Work and the Work of all Subcontractors, for all costs and expenses not included in the Cost of Extra Work, whether or not such costs and expenses are specifically referred to in Article 7.3.3. The Contractor Fee shall not be compounded.

The Contractor Fee shall be computed as follows:

- .1 Fifteen percent (15%) of the cost of that portion of the Extra Work to be performed by the prime contractor with its own forces.
- .2 Fifteen percent (15%) of the cost of that portion of the Work to be performed by a Subcontractor with its own forces, plus 5% for the prime contractor. Total combined Contractor and Subcontractor fee shall not exceed 20%.
- .3 Fifteen percent (15%) of the cost of that portion of the Work to be performed by a sub-subcontractor with its own forces, or any lower tier of Subcontractor, plus 5% for the Subcontractor, plus 5% for the prime contractor. Total combined Contractor, Subcontractor and all sub-subcontractor fee shall not exceed 25%.

7.3.5 Compensation for Extra Work shall be computed on the basis of one or more of the following:

- .1 Where the Work involved is covered by Unit Prices contained in the Contract Documents, by application of the Unit Prices to the quantities of the items involved.
- .2 Where Unit Prices are not applicable, a mutually agreed upon lump sum supported by a Cost Proposal pursuant to 7.3.1.
- .3 Where Contractor and University cannot agree upon a lump sum, by Cost of Extra Work plus Contractor Fee applicable to such Extra Work.

7.3.6 As a condition to Contractor's right to an adjustment of the Contract Sum pursuant to Article 7.3.5.3, Contractor must keep daily detailed and accurate records itemizing each element of cost and shall provide substantiating records and documentation, including time cards and invoices. Such records and documentation shall be submitted to University's Representative on a daily basis.

7.3.7 For Work to be deleted by Change Order, the reduction of the Contract Sum shall be computed on the basis of one or more of the following:

- .1 Unit Prices stated in the Contract Documents.
- .2 Where Unit Prices are not applicable, a lump sum agreed upon by University and Contractor, based upon the actual costs which would have been incurred in performing the deleted portions of the Work as calculated in accordance with Articles 7.3.2 and 7.3.3, supported by a Cost Proposal pursuant to Article 7.3.1.

7.3.8 If any one Change involves both Extra Work and Deleted Work in the same portion of the Work, a Contractor fee will not be allowed if the deductive cost exceeds the additive cost. If the additive cost exceeds the deductive cost, a Contractor Fee will be allowed only on the difference between the two amounts.

7.3.9 The Contract Sum will be adjusted for a delay if, and only if, Contractor demonstrates that all of the following three conditions are met:

- .1 Condition Number One: The delay results in an extension of the Contract Time pursuant to Article 8.4.1.
- .2 Condition Number Two: The delay is caused solely by one or more of the following:
 - .1 An error or omission in the Contract Documents; or
 - .2 The University's decision to change the scope of the Work, where such decision is not the result of any default or misconduct of the Contractor; or
 - .3 The University's decision to suspend the Work, where such decision is not the result of any default or misconduct of the Contractor; or
 - .4 The failure of the University (including the University acting through its consultants, Design Professionals, Separate Contractors or the University's Representative) to perform any Contract obligation where the failure to so perform is not the result of any default or misconduct of the Contractor.
 - .5 A materially differing site condition pursuant to Article 3.17.
- .3 Condition Number Three: The delay is not concurrent with a delay caused by an event other than those listed in Article 7.3.9.2.

7.3.10 For each day of delay that meets all three conditions prescribed in Article 7.3.9 the Contract Sum will be adjusted by the daily rate included in the Agreement and specifically identified as the rate to be paid to Contractor for Compensable Delays. Pursuant to Article 9.7.4, said daily rate shall not apply to delays occurring after Substantial Completion.

7.3.11 Except as provided in Articles 7 and 8, Contractor shall have no claim for damage or compensation for any delay, interruption, hindrance, or disruption.

7.3.12 If for any reason one or more of the conditions prescribed in Article 7.3.9 is held legally unenforceable, the remaining conditions must be met as a condition to obtaining an adjustment of the Contract Time under Article 7.3.10.

7.4 FIELD ORDERS

7.4.1 Field Orders issued by the University Representative shall be subject to the following:

- .1 A Field Order may state that it does or does not constitute a change in the Work.
- .2 If the Field Order states that it does not constitute a change in the Work and the Contractor asserts that the Field Order constitutes a change in the Work, in order to obtain an adjustment of the Contract Sum or Contract Time for the Work encompassed by the Field Order, Contractor must follow all procedures set forth in Article 4, starting with the requirement of submitting a timely Change Order Request within 7 days of

Contractor's receipt of the Field Order; failure to strictly follow those procedures is a bar to any Claim for an adjustment of the Contract Sum or Contract Time arising from performance of the Work described in the Field Order.

- .3 If the Field Order states that it does constitute a change in the Work, the Work described in the Field Order shall be considered Extra Work and the Contractor shall be entitled to an adjustment of the Contract Sum and Contract Time, calculated under and subject to Contractor's compliance with the procedures for verifying and substantiating costs and delays in Articles 7 and 8.
- .4 In addition, if the Field Order states that it does constitute a change in the Work, the Field Order may or may not contain University's estimate of adjustment of Contract Sum and/or Contract Time. If the Field Order contains an estimate of adjustment of Contract Sum or Contract Time, the Field Order is subject to the following:
 - .1 The Contractor shall not exceed the University's estimate of adjustment to Contract Sum or Contract Time without prior written notification to the University's Representative.
 - .2 If the Contractor asserts that the change in the Work encompassed by the Field Order may entitle Contractor to an adjustment of Contract Sum or Contract Time in excess of the University's estimate, in order not to be bound by University's estimate Contractor must follow all procedures set forth in Article 4, starting with the requirement of submitting a timely Change Order Request within 7 days of Contractor's receipt of the Field Order; failure to strictly follow those procedures is a bar to any Claim for an adjustment of the Contract Sum or Contract Time, in excess of the University's estimate, arising from performance of the Work described in the Field Order.

7.4.2 Upon receipt of a Field Order, Contractor shall promptly proceed to perform the Work as ordered in the Field Order notwithstanding any disagreement by the Contractor concerning whether the Work is extra.

7.5 VARIATION IN QUANTITY OF UNIT PRICE WORK

7.5.1 University has the right to increase or decrease the quantity of any Unit price item for which an Estimated Quantity is stated in the Bid Form.

7.6 WAIVER

7.6.1 A waiver of or failure by University or University's Representative to enforce any requirement in this Article 7, including without limitation the requirements in Articles 7.3.6, 7.3.8, 7.3.9, 7.3.10, 7.3.11, or 7.3.12 in connection with any adjustment of the Contract Sum, will not constitute a waiver of, and will not preclude the University or University's Representative from enforcing, such requirements in connection with any other adjustments of the Contract Sum.

7.6.2 The Contractor agrees and understands that no oral approval, either express or implied, of any adjustment of the Contract Sum by University or its agents shall be binding upon University unless and until such approval is ratified by execution of a written Change Order.

ARTICLE 8 CONTRACT TIME

8.1 COMMENCEMENT OF THE WORK

8.1.1 The date of commencement of the Work shall be set forth in the Notice To Proceed. The date of

commencement of the Work shall not be postponed by the failure of Contractor, Subcontractors, or of persons or firms for whom Contractor is responsible, to act.

8.2 PROGRESS AND COMPLETION

8.2.1 By signing the Agreement:

- .1 Contractor represents to University that the Contract Time is reasonable for performing the Work and that Contractor is able to perform the Work within the Contract Time.
- .2 Contractor agrees that University is purchasing the right to have the Contractor present on the Project site for the full duration of the Contract Time, even if Contractor could finish the Contract in less than the Contract Time.

8.2.2 Contractor shall not, except by agreement or instruction of University in writing, commence operations on the Project site or elsewhere prior to the effective date of insurance required by Article 11 to be furnished by Contractor. The dates of commencement and Final Completion of the Work shall not be changed by the effective date of such insurance.

8.2.3 Contractor shall proceed expeditiously with adequate forces and shall achieve full completion of the Work within the Contract Time. If University's Representative determines and notifies Contractor that Contractor's progress is such that Contractor will not achieve full completion of the Work within the Contract Time, Contractor shall immediately and at no additional cost to University, take all measures necessary, including working such overtime, additional shifts, Sundays, or holidays as may be required to ensure that the Work is fully completed within the Contract Time. Upon receipt of such notice from University's representative, Contractor shall immediately notify University's Representative of all measures to be taken to ensure full completion of the Work within the Contract Time. Contractor shall reimburse University for any extra costs or expenses (including the reasonable value of any services provided by University's employees) incurred by University as the result of such measures.

8.3 DELAY

8.3.1 Except and only to the extent provided otherwise in Articles 7 and 8, by signing the Agreement, Contractor agrees:

- .1 to bear the risk of delays to the Work; and
- .2 that Contractor's bid for the Contract was made with full knowledge of this risk.

In agreeing to bear the risk of delays to the Work, Contractor understands that, except and only to the extent provided otherwise in Articles 7 and 8, the occurrence of events that delay the Work shall not excuse Contractor from its obligation to achieve Final Completion of the Work within the Contract Time, and shall not entitle the Contractor to an adjustment of the Contract Sum.

8.4 ADJUSTMENT OF THE CONTRACT TIME FOR DELAY

8.4.1 Subject to Article 8.4.2, the Contract Time will be extended for each day of delay for which Contractor demonstrates that all of the following four conditions have been met; a time extension will not be granted for any day of delay for which Contractor fails to demonstrate compliance with the four conditions:

- .1 Condition Number One: The delay is critical. A delay is critical if and only to the extent it delays a work activity that cannot be delayed without delaying Final Completion of the Work beyond the Contract Time. Under this Article 8.4.1.2, if the Contract Schedule shows Final Completion of the Work before expiration of the Contract Time, a delay is critical if and only to the extent the delay pushes

Final Completion of the Work to a date that is beyond the Contract Time.

- .2 Condition Number Two: Within 7 days of the date the Contractor discovers or reasonably should discover an act, error, omission or unforeseen condition or event causing the delay is likely to have an impact on the critical path of the Project, (even if the Contractor has not yet been delayed when the Contractor discovers or reasonably should discover the critical path impact of the act, error, omission or unforeseen condition giving rise to the delay) the Contractor submits both a timely and complete Change Order Request that meets the requirements of Article 4.2.
- .3 Condition Number Three: The delay is not caused by:
 - .1 A concealed, unforeseen or unknown condition or event except for a materially differing site condition pursuant to Article 3.17; or
 - .2 The financial inability, misconduct or default of the Contractor, a Subcontractor or supplier; or
 - .3 The unavailability of materials or parts.
- .4 Condition Number Four: The delay is caused by:
 - .1 Fire; or
 - .2 Strikes, boycotts, or like obstructive actions by labor organizations; or
 - .3 Acts of God (As used herein, "Acts of God" shall include only earthquakes in excess of a magnitude of 3.5 on the Richter Scale and tidal waves); or
 - .4 A materially differing site condition pursuant to Article 3.17; or
 - .5 An error or omission in the Contract; or
 - .6 The University's decision to change the scope of the Work, where such decision is not the result of any default or misconduct of the Contractor; or
 - .7 The University's decision to suspend the Work, where such decision is not the result of any default or misconduct of the Contractor; or
 - .8 The failure of the University (including the University acting through its consultants, Design Professionals, Separate Contractors or the University's representative) to perform any Contract obligation unless such failure is due to Contractor's default or misconduct.
 - .9 "Adverse weather," but only for such days of adverse weather, or on-site conditions caused by adverse weather, that are in excess of the number of days specified in the Supplementary Conditions. In order for a day to be considered a day of adverse weather for the purpose of determining whether Contractor is entitled to an adjustment in Contract Time, both of the following conditions must be met:
 - .1 the day must be a day in which, as a result of adverse weather, less than one half day of critical path work is performed by Contractor; and
 - .2 the day must be identified in the Contract Schedule as a scheduled work day.

8.4.2 If and only if a delay meets all four conditions prescribed in Article 8.4.1, then a time extension will be granted for each day that Final Completion of the Work is delayed beyond the Contract Time, subject to the following:

.1 When two or more delays (each of which meet all four conditions prescribed in Article 8.4.1) occur concurrently on the same day, and each such concurrent delay by itself without consideration of the other delays would be critical, then all such concurrent delays shall be considered critical. For the purpose of determining whether and to what extent the Contract Time should be adjusted pursuant to Article 8.4.2, such concurrent critical delays shall be treated as a single delay for each such day.

.2 Contractor shall be entitled to a time extension for a day of delay that meets all four requirements of Article 8.4.1 if the delay is concurrent with a delay that does not meet all four conditions of Article 8.4.1.

8.4.3 If for any reason one or more of the four conditions prescribed in Article 8.4.1 is held legally unenforceable, then all remaining conditions must be met as a condition to obtaining an extension of the Contract Time under Article 8.4.2.

8.5 COMPENSATION FOR DELAY

8.5.1 To the maximum extent allowed by law, any adjustment of the Contract Sum as the result of delays shall be limited to the amounts specified in Article 7. Such adjustment shall, to the maximum extent allowed by law, constitute payment in full for all delay related costs (including costs for disruption, interruption and hindrance, general conditions, on and off-site overhead and profit) of Contractor, its Suppliers and Subcontractors of all tiers and all persons and entities working under or claiming through Contractor in connection with the Project.

8.5.2 By signing the Agreement, the parties agree that the University is buying the right to do any or all of the following, which are reasonable and within the contemplation of the parties:

- .1 To order changes in the Work, regardless of the extent and number of changes, including without limitation:
 - .1 Changes to correct errors or omissions, if any, in the Contract Documents.
 - .2 Changes resulting from the University's decision to change the scope of the Work subsequent to execution of the Contract.
 - .3 Changes due to unforeseen conditions.
- .2 To suspend the Work or any part thereof.
- .3 To delay the Work, including without limitation, delays resulting from the failure of the University or the University's Representative to timely perform any Contract obligation and delays for University's convenience.

8.6 WAIVER

8.6.1 A waiver of or failure by University or University's Representative to enforce any requirement in this Article 8, including without limitation the requirements in Article 8.4, in connection with any or all past delays shall not constitute a waiver of, and shall not preclude the University or University's Representative from enforcing, such requirements in connection with any present or future delays.

8.6.2 Contractor agrees and understands that no oral approval, either express or implied, of any time extension by University or its agents shall be binding upon University unless and until such approval is

ratified by execution of a written Change Order.

ARTICLE 9 PAYMENTS AND COMPLETION

9.1 COST BREAKDOWN

9.1.1 Within 10 days after receipt of the Notice of Selection as the apparent lowest responsible Bidder, and with the Agreement, Contractor shall submit to University's Representative a Cost Breakdown of the Contract Sum in the form contained in the Exhibits. The Cost Breakdown shall itemize as separate line items the cost of each Work Activity and all associated costs, including but not limited to warranties, as-built documents, overhead expenses, and the total allowance for profit. Insurance and bonds shall each be listed as separate line items. The total of all line items shall equal the Contract Sum. The Cost Breakdown, when approved by the University's Representative, shall become the basis for determining the cost of Work performed for Contractor's Applications for Payment.

9.2 PROGRESS PAYMENT

9.2.1 University agrees to pay monthly to Contractor, subject to Article 9.4.3, an amount equal to 95% of the sum of the following:

- .1 Cost of the Work in permanent place as of the date of the Contractor's Application For Payment.
- .2 Plus cost of materials not yet incorporated in the Work, subject to Article 9.3.5.
- .3 Less amounts previously paid.

Under this Article 9.2.1, University may, but is not required, to pay Contractor more frequently than monthly.

9.2.2 After Substantial Completion and subject to Article 9.4.3, University will make any of the remaining progress payments in full.

9.3 APPLICATION FOR PAYMENT

9.3.1 On or before the 10th day of the month or such other date as is established by the Contract Documents, Contractor shall submit to University's Representative an itemized Application For Payment, for the cost of the Work in permanent place, as approved by University's Representative, which has been completed in accordance with the Contract Documents, less amounts previously paid.

The Application For Payment shall be prepared as follows:

- .1 Use the form contained in the Exhibits.
- .2 Itemize in accordance with the Cost Breakdown.
- .3 Include such data substantiating Contractor's right to payment as University's Representative may reasonably require, such as invoices, certified payrolls, daily time and material records, and, if securities are deposited in lieu of retention pursuant to Article 9.5, a certification of the market value of all such securities as of a date not earlier than 5 days prior to the date of the Application For Payment.
- .4 Itemize retention.

9.3.2 Applications For Payment shall not include requests for payment on account of (1) changes which have not been authorized by Change Orders or (2) amounts Contractor does not intend to pay a Subcontractor because of a dispute or other reason.

9.3.3 If required by University, an Application For Payment shall be accompanied by (1) a summary showing payments that will be made to Subcontractors covered by such application and conditional releases upon progress payment or final payment and (2) unconditional waivers and releases of claims and stop notices, in the form contained in the Exhibits, from each Subcontractor listed in the preceding Application For Payment covering sums disbursed pursuant to that preceding Application For Payment.

9.3.4 Contractor warrants that, upon submittal of an Application For Payment, all Work, for which Certificates For Payment have been previously issued and payment has been received from University, shall be free and clear of all claims, stop notices, security interests, and encumbrances in favor of Contractor, Subcontractors, or other persons or firms entitled to make claims by reason of having provided labor, materials, or equipment relating to the Work.

9.3.5 At the sole discretion of University, University's Representative may approve for inclusion in the Application For Payment the cost of materials not yet incorporated in the Work but already delivered and suitably stored either at the Project site or at some other appropriate location acceptable to University's Representative. In such case, Contractor shall furnish evidence satisfactory to University's Representative (1) of the cost of such materials and (2) that such materials are under the exclusive control of Contractor. Only materials to be incorporated in the Work will be considered for payment. Any payment shall not be construed as acceptance of such materials nor relieve Contractor from sole responsibility for the care and protection of such materials; nor relieve Contractor from risk of loss to such materials from any cause whatsoever; nor relieve Contractor from its obligation to complete the Work in accordance with the Contract; nor act as a waiver of the right of University to require fulfillment of all terms of the Contract. Nothing contained within this Article 9.3.5 shall be deemed to obligate University to agree to payment for any non-incorporated materials or any part thereof, payment being in the sole and absolute discretion of University.

9.4 CERTIFICATE FOR PAYMENT

9.4.1 If Contractor has submitted an Application For Payment in accordance with Article 9.3, University's Representative shall, not later than 5 working days after the date of receipt of the Application For Payment, issue to University, with a copy to Contractor, a Certificate For Payment for such amount as University's Representative determines to be properly due.

9.4.2 If any such Application For Payment is determined not to be in accordance with Article 9.3, University will inform Contractor as soon as practicable, but not later than 5 working days after receipt. Thereafter, Contractor shall have 3 days to revise and resubmit such Application For Payment; otherwise University's Representative may issue a Certificate For Payment in the amount that University's Representative determines to be properly due without regard to such Application For Payment.

9.4.3 Approval of all or any part of an Application For Payment may be withheld, a Certificate For Payment may be withheld, and all or part of a previous Certificate For Payment may be nullified and that amount withheld from a current Certificate For Payment on account of any of the following:

- .1 Defective Work not remedied.
- .2 Third-party claims against Contractor or University arising from the acts or omissions of Contractor or Subcontractors.
- .3 Stop notices.
- .4 Failure of Contractor to make timely payments due Subcontractors for material or labor.
- .5 A reasonable doubt that the Work can be completed for the balance of the Contract Sum then unpaid.
- .6 Damage to University or Separate Contractor for which Contractor is responsible.
- .7 Reasonable evidence that the Work will not be completed within the Contract Time; and that the unpaid balance of the Contract Sum would not be adequate to

- cover University's damages for the anticipated delay.
- .8 Failure of Contractor to maintain and update as-built documents.
- .9 Failure of Contractor to submit schedules or their updates as required by the Contract Documents.
- .10 Failure to provide conditional or unconditional releases from any Subcontractor or supplier, if such waiver(s) have been requested by University's Representative.
- .11 Performance of Work by Contractor without properly processed Shop Drawings.
- .12 Liquidated damages assessed in accordance with Article 5 of the Agreement.
- .13 Failure to provide updated Reports of Subcontractor Information and Self-Certifications, as applicable.
- .14 Failure to provide a Final Distribution of Contract Dollars with final Application for Payment.
- .14 Any other failure of Contractor to perform its obligations under the Contract Documents.

9.4.4 Subject to the withholding provisions of Article 9.4.3, University will pay Contractor the amount set forth in the Certificate For Payment no later than 10 days after the issuance of the Certificate For Payment.

9.4.5 Neither University nor University's Representative will have an obligation to pay or to see to the payment of money to a Subcontractor, except as may otherwise be required by law.

9.4.6 Neither a Certificate For Payment nor a progress payment made by University will constitute acceptance of Defective Work.

9.5 DEPOSIT OF SECURITIES IN LIEU OF RETENTION AND DEPOSIT OF RETENTION INTO ESCROW

9.5.1 At the request and expense of Contractor, a substitution of securities may be made for any monies retained by University under Article 9.2 to ensure performance under the Contract Documents. Securities equivalent in value to the retention amount required by the Contract Documents for each Certificate For Payment shall be deposited by Contractor with a state or federally chartered bank in the State of California ("Escrow Agent"), which shall hold such securities pursuant to the escrow agreement referred to in Article 9.5.3 until retention is due in accordance with Article 9.8. Securities shall be valued as often as conditions of the securities market warrant, but in no case less than once per month. Contractor shall deposit additional securities so that the current market value of the total of all deposited securities shall be at least equal to the total required amount of retention.

9.5.2 Alternatively to Article 9.5.1, and at the request and expense of Contractor, University will deposit retention directly with Escrow Agent. Contractor may direct the investment of such deposited retention into interest bearing accounts or securities, and such deposits or securities shall be held by Escrow Agent upon the same terms provided for securities deposited by Contractor. Contractor and its surety shall bear the risk of failure of the Escrow Agent selected.

9.5.3 A prerequisite to the substitution of securities in lieu of retention or the deposit of retention into escrow shall be the execution by Contractor, University, and Escrow Agent of an Escrow Agreement for Deposit of Securities in Lieu of Retention and Deposit of Retention in the form contained in the Exhibits. The Contractor shall submit the Selection of Retention Options and the Escrow Agreement for Deposit of Securities in Lieu of Retention and Deposit of Retention not later than the date when 50% of the Work has been completed. The terms of such escrow agreement are incorporated into the requirements of this Article 9.5.

9.6 BENEFICIAL OCCUPANCY

9.6.1 University reserves the right, at its option and convenience, to occupy or otherwise make use of any part of the Work at any time prior to Substantial Completion or Final Completion upon 10 days' notice to Contractor. Such occupancy or use is herein referred to as "Beneficial Occupancy." Beneficial Occupancy shall be subject to the following conditions:

- .1 University's Representative will make an inspection of the portion of the Project to be beneficially occupied and prepare a list of items to be completed or corrected prior to Final Completion. Prior to Beneficial Occupancy, University will issue a Certificate of Beneficial Occupancy on University's form.
- .2 Beneficial Occupancy by University shall not be construed by Contractor as an acceptance by University of that portion of the Work which is to be occupied.
- .3 Beneficial Occupancy by University shall not constitute a waiver of existing claims of University or Contractor against each other.
- .4 Contractor shall provide, in the areas beneficially occupied and on a 24 hour and 7 day week basis as required, utility services, heating, and cooling for systems which are in operable condition at the time of Beneficial Occupancy. All responsibility for the operation and maintenance of equipment shall remain with Contractor while the equipment is so operated. Contractor shall submit to University an itemized list of each piece of equipment so operated with the date operation commences.
- .5 The Guarantee to Repair Periods, as defined in Article 12.2, will commence upon the occupancy date stated in the Certificate of Beneficial Occupancy except that the Guarantee to Repair Periods for that part of equipment or systems that serve portions of the Work for which University has not taken Beneficial Occupancy or issued a Certificate of Substantial Completion shall not commence until the University has taken Beneficial Occupancy for that portion of the Work or has issued a Certificate of Substantial Completion with respect to the entire Project.
- .6 University will pay all normal operating and maintenance costs resulting from its use of equipment in areas beneficially occupied.
- .7 University will pay all utility costs which arise out of the Beneficial Occupancy.
- .8 Contractor shall not be responsible for providing security in areas beneficially occupied.
- .9 University will use its best efforts to prevent its Beneficial Occupancy from interfering with the conduct of Contractor's remaining Work.
- .10 Contractor shall not be required to repair damage caused by University in its Beneficial Occupancy.
- .11 Except as provided in this Article 9.6, there shall be no added cost to University due to Beneficial Occupancy.
- .12 Contractor shall continue to maintain all insurance required by the Contract in full force and effect.

9.7 SUBSTANTIAL COMPLETION

9.7.1 "Substantial Completion" means the stage in the progress of the Work, as determined by University's Representative, when the Work is complete and in accordance with the Contract Documents except only for completion of minor items which do not impair University's ability to occupy and fully utilize the Work for its intended purpose and a Certificate of Occupancy has been issued by the University's Building Official.

9.7.2 When Contractor gives notice to University's Representative that the Work is substantially complete, unless University's Representative determines that the Work is not sufficiently complete to warrant an inspection to determine Substantial Completion, University's Representative will inspect the

Work. If the University's Representative determines that the Work is not substantially completed the University's Representative will prepare and give to Contractor a comprehensive list of items to be completed or corrected before establishing Substantial Completion. Contractor shall proceed promptly to complete and correct items on the list. Failure to include an item on such list does not alter the responsibility of Contractor to complete all Work in accordance with the Contract Documents. Upon notification that the items on the list are completed or corrected, as applicable, the University's Representative will make an inspection to determine whether the Work is substantially complete. Costs for additional inspection by University's Representative shall be deducted from any monies due and payable to Contractor.

9.7.3 When University's Representative determines that the Work is substantially complete, University's Representative will arrange for inspection by University's Building Official and other officials, as appropriate, for the purpose of issuing a Certificate of Occupancy. After a Certificate of Occupancy has been issued by the University's Building Official, the University's Representative will prepare a Certificate of Substantial Completion on University's form as contained in the Exhibits, which, when signed by University, shall establish the date of Substantial Completion and the responsibilities of University and Contractor for security, maintenance, utilities, insurance, and damage to the Work. The University's Representative will prepare and furnish to the Contractor a comprehensive "punch list" of items to be completed or corrected prior to Final Completion.

9.7.4 Unless otherwise provided in the Certificate of Substantial Completion, the Guarantee To Repair Period for the Work covered by the Certificate of Substantial Completion, shall commence on the date of Substantial Completion of the Work except that Substantial Completion shall not commence the Guarantee to Repair Period for any equipment or systems that:

- .1 Are not operational (equipment or systems shall not be considered operational if they cannot be used to provide the intended service; or
- .2 Are not accepted by the University.

The Guarantee To Repair Period for equipment or systems which become operational and accepted subsequent to Substantial Completion will begin on the date of their written acceptance by University.

9.7.5 The daily rate included in the Agreement and specifically identified as the rate to be paid to Contractor for Compensable Delays shall not apply to any delays occurring after the Work is substantially completed.

9.8 FINAL COMPLETION, FINAL PAYMENT, AND RELEASE OF RETENTION

9.8.1 Upon receipt of notice from Contractor that the Work is ready for final inspection, University's Representative will make such inspection. Final Completion shall be when University's Representative determines that the Work is fully completed and in accordance with the Contract Documents, including without limitation, satisfaction of all "punch list" items, and determines that a Certificate of Occupancy has been issued by the University's Building Official. University will file a Notice of Completion within 15 days after Final Completion. After receipt of the final Application For Payment, if University's Representative determines that Final Completion has occurred, University's Representative will issue the final Certificate For Payment.

9.8.2 Final payment and retention shall be released to Contractor, as set forth in Article 9.8.3, after:

- .1 Contractor submits the final Application For Payment and all submittals required in accordance with Article 9.3;
- .2 Contractor submits all guarantees and warranties procured by Contractor from Subcontractors, all operating manuals for equipment installed in the Project, as-built documents, and all other submittals required by the Contract Documents;

.3 Contractor submits the Final Distribution of Contract Dollars in the form contained in the Exhibits; and

.4 University's Representative issues the final Certificate For Payment.

At its sole discretion, after Final Completion, University may waive the requirement that Contractor submit a final Application For Payment before making final payment and/or release of retention to Contractor.

9.8.3 Final payment shall be paid not more than 10 days after University's Representative issues the final Certificate For Payment. Retention shall be released to Contractor 35 days after the filing of the Notice of Completion.

9.8.4 Acceptance of final payment by Contractor shall constitute a waiver of all claims, except claims for retention and claims previously made in writing and identified by Contractor as unsettled at the time of the final Application For Payment.

ARTICLE 10 PROTECTION OF PERSONS AND PROPERTY

10.1 SAFETY PRECAUTIONS AND PROGRAMS

10.1.1 Contractor shall be solely responsible for initiating, maintaining, and supervising all safety precautions and programs in connection with the performance of the Contract.

10.2 SAFETY OF PERSONS AND PROPERTY

10.2.1 Contractor shall take adequate precautions for safety of and shall provide adequate protection to prevent damage, injury, or loss to the following:

- .1 Employees involved in the Work and other persons who may be affected thereby.
- .2 The Work in place and materials and equipment to be incorporated therein, whether in storage on or off the Project site, under care, custody, or control of Contractor or Subcontractors.
- .3 Other property at the Project site and adjoining property.

10.2.2 Contractor shall erect and maintain, as required by existing conditions and performance of the Work, adequate safeguards for safety and protection, including providing adequate lighting and ventilation, posting danger signs and other warnings against hazards, promulgating safety regulations, and notifying owners and users of adjacent sites and utilities.

10.2.3 When use or storage of explosives, other hazardous materials, equipment, or unusual methods are necessary for execution of the Work, Contractor shall exercise the utmost care and carry on such activities only under the supervision of properly qualified personnel.

10.2.4 Contractor shall designate a responsible member of Contractor's organization at the Project site whose duty shall be the prevention of accidents. That person shall be the Superintendent, unless otherwise designated by Contractor in writing to University and University's Representative.

10.2.5 Contractor shall not load or permit any part of the Work or the Project site to be loaded so as to endanger the safety of persons or property.

10.3 EMERGENCIES

10.3.1 In an emergency affecting the safety of persons or property, Contractor shall act to prevent or minimize damage, injury, or loss. Contractor shall promptly notify University's Representative, which notice may be oral followed by written confirmation, of the occurrence of such an emergency and Contractor's action.

ARTICLE 11 INSURANCE AND BONDS

11.1 CONTRACTOR'S INSURANCE

11.1.1 Contractor shall, at its expense, purchase and maintain in full force and effect such insurance as will protect itself and University from claims, such as for bodily injury, wrongful death, and property damage, which may arise out of or result from the Work required by the Contract Documents, whether such Work is done by Contractor, by any Subcontractor, by anyone directly or indirectly employed by any of them, or by anyone for whose acts any of them may be liable. The amounts of such insurance and any additional insurance requirements are specified in the Supplementary Conditions. See Article 3.21 regarding the scope and extent of Contractor's liability for and repair of damaged Work.

11.1.2 The following policies and coverages shall be furnished by Contractor:

- .1 **COMMERCIAL FORM GENERAL LIABILITY INSURANCE** covering all Work done by or on behalf of Contractor and providing insurance for bodily injury, wrongful death, personal injury, property damage, and contractual liability. Except with respect to bodily injury and property damage included within the products and completed operations hazards, the aggregate limit shall apply separately to Work required of Contractor by these Contract Documents. If the insurance under this Article 11.1.2.1 is written on a claims-made form, coverage shall continue for a period of not less than 3 years following termination of this Contract. Coverage shall provide for a retroactive date of placement prior to or coinciding with the effective date of this Contract.
- .2 **BUSINESS AUTOMOBILE LIABILITY INSURANCE** on an "Occurrence" form covering owned, hired, leased, and non-owned automobiles used by or on behalf of Contractor and providing insurance for bodily injury and property damage.
- .3 **WORKERS' COMPENSATION AND EMPLOYER'S LIABILITY INSURANCE** as required by Federal and State of California law. Contractor shall also require all of its Subcontractors to maintain this insurance coverage.

11.1.3 The coverages required under this Article 11 shall not in any way limit the liability of Contractor.

11.1.4 Certificates of Insurance, as evidence of the insurance required by these Contract Documents and on the form contained in the Exhibits, shall be submitted by Contractor to University. The Certificates of Insurance shall provide for no cancellation or modification of coverage without prior written notice to University, in accordance with policy provisions.

11.1.5 In the event Contractor does not comply with these insurance requirements, University may, at its option, provide insurance coverage to protect University; and the cost of such insurance shall be paid by Contractor and may be deducted from the Contract Sum.

11.1.6 Contractor's insurance as required by Article 11.1.2, shall, by endorsement to the policies, include the following:

- .1 The Regents of the University of California, The University of California, University, and each of their Representatives, consultants, officers, agents, employees, and each of their Representative's consultants, regardless of whether or not identified in the Contract Documents or to the Contractor in writing, will be included as additional insureds on the Contractor's General Liability insurance for and relating to the Work to be performed by the Contractor and Subcontractors pursuant to additional insured endorsement CG2010 (11/85) or a combination of both CG 2010 (10/01 or 07/04) and CG 2037 (10/01 or 07/04). This requirement shall not apply to Worker's Compensation and Employer's Liability insurance.
- .2 A Severability of Interest Clause that shall be primary insurance as respects The Regents of the University of California, its officers, agents and employees. Any insurance or self-insurance maintained by The Regents of the University of California shall be excess of and non-contributory with this insurance. The provision shall state that, "The term 'insured' is hereby used severally and not collectively, but the inclusion herein of more than one insured shall not operate to increase the limits of the insurers' liability."
- .3 A Cross Liability Clause stating that, "In the event of claims being made under any of the coverages of the policies referred to herein by one or more insureds hereunder for which another insured hereunder may be liable, then the policies shall cover such insureds against whom a claim is made or may be made in the same manner as if separate policies had been issued to each insured hereunder. Nothing contained herein, however, shall operate to increase the insurers' limits of liability as set forth in the insuring agreements."
- .4 University, University's consultants, University's Representative, and University's Representative's consultants will not by reason of their inclusion as insureds incur liability to the insurance carriers for payment of premiums for such insurance.
- .5 Coverage provided is primary and is not in excess of or contributing with any insurance or self-insurance maintained by University, University's consultants, University's Representative, and University's Representative's consultants. This provision, however, shall only apply as per the stipulations of Article 11.1.6.1.

11.1.7 The form and substance of all insurance policies required to be obtained by Contractor shall be subject to approval by University. All policies required by Articles 11.1.2.1, 11.1.2.2, and 11.1.2.3 shall be issued by companies with ratings and financial classifications as specified in the Supplementary Conditions.

11.1.8 Contractor shall, by mutual agreement with University, furnish any additional insurance as may be required by University. Contractor shall provide Certificates of Insurance evidencing such additional insurance.

11.1.9 The Certificate of Insurance shall show (1) all companies affording coverage and (2) the name of the insured exactly in the manner as shown on the Bid Form. The name of the insured must be the name under which the entity is licensed by the Contractors State License Board.

11.1.10 If insurance company refuses to use the Certificate of Insurance form as contained in the Exhibits, it must provide a Certificate of Insurance evidencing compliance with this Article and Special Provisions 1

through 3 on the Certificate of Insurance Exhibit by including an endorsement to its Certificate of Insurance form covering Special Provisions 1 through 3 exactly as these provisions appear on the Certificate of Insurance Exhibit.

11.1.11 At the request of University, Contractor shall submit to University copies of the policies obtained by Contractor.

11.2 BUILDER'S RISK PROPERTY INSURANCE

11.2.1 If and only if the Contract Sum exceeds \$200,000 at the time of award, University will provide its standard builder's risk property insurance, subject to the deductibles, terms and conditions, exclusions, and limitations as contained in the provisions of the policy. A copy of the University's standard builder's risk property insurance policy is available at the University's Facility office. In addition, a summary of the provisions of the policy is included as an Exhibit to the Contract. Contractor agrees that the University's provision of its standard builder's risk property insurance policy meets the University's obligation to provide builder's risk property insurance under the Contract and, in the event of a conflict between the provisions of the policy and any summary or description of the provisions contained herein or otherwise, the provisions of the policy shall control and shall be conclusively presumed to fulfill the University's obligation to provide such insurance. The proceeds under such insurance policies taken out by University insuring the Work and materials will be payable to University and Contractor as their respective interests, from time to time, may appear. Contractor shall be responsible for the deductible amount in the event of a loss. In addition, nothing in this Article 11.2 shall be construed to relieve Contractor of full responsibility for loss of or damage to materials not incorporated in the Work, and for Contractor's tools and equipment used to perform the Work, whether on the Project site or elsewhere, or to relieve Contractor of its responsibilities referred to under this Article 11. Materials incorporated in the Work, as used in this Article 11.2, shall mean materials furnished while in transit to, stored at, or in permanent place at the Project site.

11.2.2 Insurance policies referred to under this Article 11.2 shall:

- .1 Include a provision that the policies are primary and do not participate with nor are excess over any other valid collectible insurance carried by Contractor.
- .2 Include a waiver of subrogation against Contractor, its Subcontractors, its agents, and employees.

11.2.3 Builder's risk insurance coverage under this Article 11.2 will expire on the date of Final Completion recited in a Notice of Completion filed pursuant to Article 9.8.1. Should a Notice of Completion be filed more than 10 days after the date of Final Completion, the date of Final Completion recited in the Notice of Completion will govern.

11.3 PERFORMANCE BOND AND PAYMENT BOND

11.3.1 Contractor shall furnish bonds covering the faithful performance of the Contract (Performance Bond) and payment of obligations arising thereunder (Payment Bond) on the forms contained in Exhibits 3 and 2.

11.3.2 The Payment Bond and Performance Bond shall each be in the amount of the Contract Sum.

11.3.3 The Payment Bond and Performance Bond shall be in effect on the date the Contract is signed by University.

11.3.4 Contractor shall promptly furnish such additional security as may be required by University to protect its interests and those interests of persons or firms supplying labor or materials to the Work. Contractor shall furnish supplemental Payment and Performance Bonds each in the amount of the current Contract Sum at the request of the University.

11.3.5 Surety companies used by Contractor shall be, on the date the Contract is signed by University, an admitted surety insurer (as defined in the California Code of Civil Procedure Section 995.120).

11.3.6 The premiums for the Payment Bond and Performance Bond shall be paid by Contractor.

ARTICLE 12 UNCOVERING AND CORRECTION OF WORK

12.1 UNCOVERING OF WORK

12.1.1 If a portion of the Work is covered contrary to University's Representative's request or direction, or contrary to the requirements of the Contract Documents, it must, if required in writing by University's Representative, be uncovered for University's Representative's observation and be replaced at Contractor's expense without adjustment of the Contract Time or the Contract Sum.

12.1.2 If a portion of the Work has been covered, which is not required by the Contract Documents to be observed or inspected prior to its being covered and which University's Representative has not specifically requested to observe prior to its being covered, University's Representative may request to see such Work and it shall be uncovered and replaced by Contractor. If such Work is in accordance with the Contract Documents, the costs of uncovering and replacing the Work shall be added to the Contract Sum by Change Order; and if the uncovering and replacing of the Work extends the Contract Time, an appropriate adjustment of the Contract Time shall be made by Change Order. If such Work is not in accordance with the Contract Documents, Contractor shall pay such costs and shall not be entitled to an adjustment of the Contract Time or the Contract Sum.

12.2 CORRECTION OF DEFECTIVE WORK AND GUARANTEE TO REPAIR PERIOD

12.2.1 The term "Guarantee To Repair Period" means a period of 1 year, unless a longer period of time is specified, commencing as follows:

- .1 For any Work not described as incomplete in the Certificate of Substantial Completion, on the date of Substantial Completion.
- .2 For space beneficially occupied or for separate systems fully utilized prior to Substantial Completion pursuant to Article 9.6, from the first date of such Beneficial Occupancy or actual use, as established in a Certificate of Beneficial Occupancy.
- .3 For all Work other than .1 or .2 above, from the date of Final Completion.

12.2.2 Contractor shall (1) correct Defective Work that becomes apparent during the progress of the Work or during the Guarantee To Repair Period and (2) replace, repair, or restore to University's satisfaction any other parts of the Work and any other real or personal property which is damaged or destroyed as a result of Defective Work or the correction of Defective Work. Contractor shall promptly commence such correction, replacement, repair, or restoration upon notice from University's Representative or University, but in no case later than 10 days after receipt of such notice; and Contractor shall diligently and continuously prosecute such correction to completion. Contractor shall bear all costs of such correction, replacement, repair, or restoration, and all losses resulting from such Defective Work, including additional testing, inspection, and compensation for University's Representative's services and expenses. Contractor shall perform corrective Work at such times that are acceptable to University and in such a manner as to avoid, to the extent practicable, disruption to University's activities.

12.2.3 If immediate correction of Defective Work is required for life safety or the protection of property and is performed by University or Separate Contractors, Contractor shall pay to University all reasonable costs of correcting such Defective Work. Contractor shall replace, repair, or restore to University's satisfaction any other parts of the Work and any other real or personal property which is damaged or

destroyed as a result of such Defective Work or the correction of such Defective Work.

12.2.4 Contractor shall remove from the Project site portions of the Work and materials which are not in accordance with the Contract Documents and which are neither corrected by Contractor nor accepted by University.

12.2.5 If Contractor fails to commence correction of Defective Work within 10 days after notice from University or University's Representative or fails to diligently prosecute such correction to completion, University may correct the Defective Work in accordance with Article 2.4; and, in addition, University may remove the Defective Work and store salvageable materials and equipment at Contractor's expense.

12.2.6 If Contractor fails to pay the costs of such removal and storage as required by Articles 12.2.4 and 12.2.5 within 10 days after written demand, University may, without prejudice to other remedies, sell such materials at auction or at private sale, or otherwise dispose of such material. Contractor shall be entitled to the proceeds of such sale, if any, in excess of the costs and damages for which Contractor is liable to University, including compensation for University's Representative's services and expenses. If such proceeds of sale do not cover costs and damages for which Contractor is liable to University, the Contract Sum shall be reduced by such deficiency. If there are no remaining payments due Contractor or the remaining payments are insufficient to cover such deficiency, Contractor shall promptly pay the difference to University.

12.2.7 Contractor's obligations under this Article 12 are in addition to and not in limitation of its warranty under Article 3.4 or any other obligation of Contractor under the Contract Documents. Enforcement of Contractor's express warranties and guarantees to repair contained in the Contract Documents shall be in addition to and not in limitation of any other rights or remedies University may have under the Contract Documents or at law or in equity for Defective Work. Nothing contained in this Article 12 shall be construed to establish a period of limitation with respect to other obligations of Contractor under the Contract Documents. Establishment of the Guarantee To Repair Period relates only to the specific obligation of Contractor to correct the Work and in no way limits either Contractor's liability for Defective Work or the time within which proceedings may be commenced to enforce Contractor's obligations under the Contract Documents.

ARTICLE 13 TERMINATION OR SUSPENSION OF THE CONTRACT

13.1 TERMINATION BY CONTRACTOR

13.1.1 Subject to Article 13.1.2, Contractor shall have the right to terminate the Contract only upon the occurrence of one of the following:

- .1 Provided that University has not commenced reasonable action to remove any order of a court within the 90 day period, the Work is stopped for 90 consecutive days, through no act or fault of Contractor, any Subcontractor, or any employee or agent of Contractor or any Subcontractor, due to an issuance of an order of a court or other public authority having jurisdiction or due to an act of government, such as a declaration of a national emergency making material unavailable.
- .2 University fails to perform any material obligation under the Contract and fails to cure such default within 30 days, or University has not commenced to cure such default within 30 days where such cure will require a reasonable period beyond 30 days and diligently prosecutes the same to completion, after receipt of notice from Contractor stating the nature of such default(s).
- .3 Repeated suspensions by University, other than such suspensions as are agreed

to by Contractor under Article 13.3, which constitute in the aggregate more than 20% of the Contract Time.

13.1.2 Upon the occurrence of one of the events listed in Article 13.1.1, Contractor may, upon 10 days additional notice to University and University's Representative, and provided that the condition giving rise to Contractor's right to terminate is continuing, terminate the Contract.

13.1.3 Upon termination by Contractor, University will pay to Contractor the sum determined by Article 13.4.4. Such payment will be the sole and exclusive remedy to which Contractor is entitled in the event of termination of the Contract by Contractor pursuant to Article 13.1; and Contractor will be entitled to no other compensation or damages and expressly waives the same.

13.2 TERMINATION BY UNIVERSITY FOR CAUSE

13.2.1 University will have the right to terminate the Contract for cause at any time after the occurrence of any of the following events:

- .1 Contractor becomes insolvent or files for relief under the bankruptcy laws of the United States.
- .2 Contractor makes a general assignment for the benefit of its creditors or fails to pay its debts as the same become due.
- .3 A receiver is appointed to take charge of Contractor's property.
- .4 The commencement or completion of any Work activity on the critical path is more than 30 days behind the date set forth in the Contract Schedule for such Work activity, as a result of an Unexcusable Delay. For a Contract with a Contract Time of less than 300 days, the 30-day period shall be reduced to the number of days commensurate with 10% of the Contract Time.
- .5 Contractor abandons the Work.

13.2.2 Upon the occurrence of any of the following events, University will have the right to terminate the Contract for cause if Contractor fails to promptly commence to cure such default and diligently prosecute such cure within 5 days after notice from University, or within such longer period of time as is reasonably necessary to complete such cure:

- .1 Contractor persistently or repeatedly refuses or fails to supply skilled supervisory personnel, an adequate number of properly skilled workers, proper materials, or necessary equipment to prosecute the Work in accordance with the Contract Documents.
- .2 Contractor fails to make prompt payment of amounts properly due Subcontractors after receiving payment from University.
- .3 Contractor disregards Applicable Code Requirements.
- .4 Contractor persistently or materially fails to execute the Work in accordance with the Contract Documents.
- .5 Contractor is in default of any other material obligation under the Contract Documents.
- .6 Contractor persistently or materially fails to comply with applicable safety requirements.

13.2.3 Upon any of the occurrences referred to in Articles 13.2.1 and 13.2.2, University may, at its election and by notice to Contractor, terminate the Contract and take possession of the Project site and all materials, supplies, equipment, tools, and construction equipment and machinery thereon owned by Contractor; accept the assignment of any or all of the subcontracts; and then complete the Work by any method University may deem expedient. If requested by University, Contractor shall remove any part or all of Contractor's materials, supplies, equipment, tools, and construction equipment and machinery from the Project site within 7 days of such request; and if Contractor fails to do so, University may remove or store,

and after 90 days sell, any of the same at Contractor's expense.

13.2.4 If the Contract is terminated by University as provided in this Article 13.2, Contractor shall not be entitled to receive any further payment until the expiration of 35 days after Final Completion and acceptance of all Work by University.

13.2.5 If the unpaid balance of the Contract Sum exceeds the cost of completing the Work, including all additional costs and expenses made necessary thereby, including costs for University staff time, plus all losses sustained, including any liquidated damages provided under the Contract Documents, such excess shall be paid to Contractor. If such costs, expenses, losses, and liquidated damages exceed the unpaid balance of the Contract Sum, Contractor shall pay such excess to University.

13.2.6 No termination or action taken by University after termination shall prejudice any other rights or remedies of University provided by law or by the Contract Documents upon such termination; and University may proceed against Contractor to recover all losses suffered by University.

13.3 SUSPENSION BY UNIVERSITY FOR CONVENIENCE

13.3.1 University may, at any time and from time to time, without cause, order Contractor, in writing, to suspend, delay, or interrupt the Work in whole or in part for such period of time, up to 90 days, as University may determine, with such period of suspension to be computed from the date of delivery of the written order. Such order shall be specifically identified as a "Suspension Order" under this Article 13.3. The Work may be stopped for such further period as the parties may agree. Upon receipt of a Suspension Order, Contractor shall, at University's expense, comply with its terms and take all reasonable steps to minimize costs allocable to the Work covered by the Suspension Order during the period of Work stoppage. Within 90 days after the issuance of the Suspension Order, or such extension to that period as is agreed upon by Contractor and University, University shall either cancel the Suspension Order or delete the Work covered by such Suspension Order by issuing a Change Order.

13.3.2 If a Suspension Order is canceled or expires, Contractor shall continue with the Work. A Change Order will be issued to cover any adjustments of the Contract Sum or the Contract Time necessarily caused by such suspension. Any Claim by Contractor for an adjustment of the Contract Sum or the Contract Time shall be made within 21 days after the end of the Work suspension. Contractor agrees that submission of its claim within said 21 days is an express condition precedent to its right to Arbitrate or Litigate such a claim.

13.3.3 The provisions of this Article 13.3 shall not apply if a Suspension Order is not issued by University. A Suspension Order shall not be required to stop the Work as permitted or required under any other provision of the Contract Documents.

13.4 TERMINATION BY UNIVERSITY FOR CONVENIENCE

13.4.1 University may, at its option, terminate this Contract, in whole or from time to time in part, at any time by giving notice to Contractor. Upon such termination, Contractor agrees to waive any claims for damages, including loss of anticipated profits, on account thereof; and, as the sole right and remedy of Contractor, University shall pay Contractor in accordance with Article 13.4.4.

13.4.2 Upon receipt of notice of termination under this Article 13.4, Contractor shall, unless the notice directs otherwise, do the following:

- .1 Immediately discontinue the Work to the extent specified in the notice.
- .2 Place no further orders or subcontracts for materials, equipment, services, or facilities, except as may be necessary for completion of such portion of the Work as is not discontinued.
- .3 Promptly cancel, on the most favorable terms reasonably possible, all subcontracts to the extent they relate to the performance of the discontinued

- portion of the Work.
- .4 Thereafter do only such Work as may be necessary to preserve and protect Work already in progress and to protect materials, plants, and equipment on the Project site or in transit thereto.

13.4.3 Upon such termination, the obligations of the Contract shall continue as to portions of the Work already performed and, subject to Contractor's obligations under Article 13.4.2, as to bona fide obligations assumed by Contractor prior to the date of termination.

13.4.4 Upon such termination, University shall pay to Contractor the sum of the following:

- .1 The amount of the Contract Sum allocable to the portion of the Work properly performed by Contractor as of the date of termination, less sums previously paid to Contractor.
- .2 Plus an amount equal to the lesser of \$50,000 or 5% of the difference between the Contract Sum and the amount of the Contract Sum allocable to the portion of the Work properly performed by Contractor as of the date of termination.
- .3 Plus previously unpaid costs of any items delivered to the Project site which were fabricated for subsequent incorporation in the Work.
- .4 Plus any proven losses with respect to materials and equipment directly resulting from such termination.
- .5 Plus reasonable demobilization costs.
- .6 Plus reasonable costs of preparing a statement of the aforesaid costs, expenses, and losses in connection with such termination.

The above payment shall be the sole and exclusive remedy to which Contractor is entitled in the event of termination of the Contract by University pursuant to Article 13.4; and Contractor will be entitled to no other compensation or damages and expressly waives same.

ARTICLE 14 STATUTORY AND OTHER REQUIREMENTS

14.1 PATIENT HEALTH INFORMATION

Contractor acknowledges that its employees, agents, subcontractors, consultants and others acting on its behalf may come into contact with Patient Health Information ("PHI") while performing work at the Project Site. This contact is most likely rare and brief (e.g. walking through a clinic where patient files may be visible, overhearing conversations between physicians while working or touring a hospital, noticing a relative or acquaintance receiving treatment in a University facility, etc.). Contractor shall immediately notify University Representative of any such contact. Any and all forms of PHI should not be examined closer, copied, photographed, recorded in any manner, distributed or shared. Contractor will adopt procedures to ensure that its employees, agents and subcontractors refrain from such activity. If Contractor, its employees, agents or subcontractors do further examine, copy, photograph, record in any manner, distribute or share this information, Contractor will report such actions immediately to the University Representative. Contractor will immediately take all steps necessary to stop any such actions and will ensure that no further violations of this contractual responsibility will occur. Contractor will report to University Representative within five (5) days after Contractor gives University Representative notice of the event/action of the steps taken to prevent future occurrences.

14.2 NONDISCRIMINATION

14.2.1 For purposes of this Article 14.2, the term Subcontractor shall not include suppliers, manufacturers, or distributors.

14.2.2 Contractor shall comply and shall ensure that all Subcontractors comply with Section 12900 through 12996, of the State of California Government Code.

14.2.3 Contractor agrees as follows during the performance of the Work:

- .1 Contractor shall provide equal treatment to, and shall not willfully discriminate against or allow harassment of any employee or applicant for employment on the basis of: race; color; religion; sex; age; ancestry; national origin; sexual orientation; physical or mental disability; veteran's status; medical condition (as defined in Section 12926 of the State of California Government Code and including cancer-related medical conditions and or genetic characteristics); genetic information (as defined in the Genetic Information Nondiscrimination Act of 2008 and including family medical history); marital status; gender identity, pregnancy, or citizenship (within the limits imposed by law or University's policy) or service in the uniformed services (as defined by the Uniformed Services Employment and Reemployment Rights Act of 1994). Contractor will also take affirmative action to ensure that any such employee or applicant for employment is not discriminated against on any of the bases identified above. Such equal treatment shall apply, but not be limited to the following: employment; upgrade; demotion or transfer; recruitment or recruitment advertising; layoff or termination; rates of pay or other forms of compensation; and selection for training, including apprenticeship. The contractor also agrees to post in conspicuous places, available to employees and applicants for employment, notices setting forth the provisions of this nondiscrimination clause. The Contractor will, in all solicitations or advertisements for employees placed by or on behalf of the Contractor, state that qualified applicants will receive consideration for employment without regard to: race; color; religion; sex; age; ancestry; national origin; sexual orientation; physical or mental disability; veteran's status; medical condition (as defined in Section 12926 of the State of California Government Code and including cancer-related medical conditions and or genetic characteristics); genetic information (as defined in the Genetic Information Nondiscrimination Act of 2008 and including family medical history); marital status; gender identity, pregnancy, or citizenship (within the limits imposed by law or University's policy) or service in the uniformed services (as defined by the Uniformed Services Employment and Reemployment Rights Act of 1994). For purposes of this provision: (1) "Pregnancy" includes pregnancy, childbirth, and medical conditions related to pregnancy and childbirth; and (2) "Service in the uniformed services" includes membership, application for membership, performance of service, application for service, or obligation for service in the uniformed services.
- .2 Contractor and all Subcontractors will permit access to their records of employment, employment advertisements, application forms, and other pertinent data and records by University or any appropriate agency of the State of California designated by University for the purposes of investigation to ascertain compliance with this Article 14.2. The outcome of the investigation may result in the following:
 - .1 A finding of willful violation of the provisions of this Contract or of the Fair Employment Practices Act may be regarded by University as (1) a basis for determining that Contractor is not a "responsible bidder" as to future contracts for which such Contractor may submit bids or (2) a basis for refusing to accept or consider the bids of Contractor for future contracts.
 - .2 University may deem a finding of willful violation of the Fair Employment Practices Act to have occurred upon receipt of written notice from the Fair Employment Practices Commission that it has (1) investigated and determined that Contractor has violated the Fair Employment Practices Act and (2) issued an order under the State of California Government Code Section 12970 or obtained an injunction under Government Code Section 12973.
 - .3 Upon receipt of such written notice from the Fair Employment Practices

- Commission, University may notify Contractor that, unless it demonstrates to the satisfaction of University within a stated period that the violation has been corrected, Contractor's bids on future projects will not be considered.
- .4 Contractor agrees that, should University determine that Contractor has not complied with this Article 14.2, Contractor shall forfeit to University, as a penalty, for each day or portion thereof, for each person who was denied employment as a result of such non-compliance, the penalties provided in Article 14.3 for violation of prevailing wage rates. Such penalty amounts may be recovered from Contractor; and University may deduct any such penalty amounts from the Contract Sum.
- .5 Nothing contained in this Article 14.2 shall be construed in any manner so as to prevent University from pursuing any other remedies that may be available at law.
- .6 Contractor shall meet the following standards for compliance and provide University with satisfactory evidence of such compliance upon University's request, which shall be evaluated in each case by University:
- .1 Contractor shall notify its Superintendent and other supervisory personnel of the nondiscrimination requirements of the Contract Documents and their responsibilities thereto.
- .2 Contractor shall notify all sources of employee referrals (including unions, employment agencies, and the State of California Department of Employment) of the nondiscrimination requirements of the Contract Documents by sending to such sources and by posting the Notice of Equal Employment Opportunity (EEO).
- .3 Contractor or its representative shall, through all unions with whom it may have agreements, develop agreements that (1) define responsibilities for nondiscrimination in hiring, referrals, upgrading, and training and (2) implement an affirmative nondiscrimination program, in terms of the unions' specific areas of skill and geography, such that qualified minority women, nonminority women, and minority men shall be available and given an equal opportunity for employment.
- .4 Contractor shall notify University of opposition to the nondiscrimination requirements of the Contract Documents by individuals, firms, or organizations during the term of the Contract.
- .7 Contractor shall include the provisions of the foregoing Articles 14.2.3.2.1 through 14.2.3.2.6 in all subcontracts with Subcontractors, so that such provisions will be binding upon each such Subcontractor.

14.3 PREVAILING WAGE RATES

14.3.1 For purposes of this Article 14.3, the term Subcontractor shall not include suppliers, manufacturers, or distributors.

14.3.2 Contractor shall comply and shall ensure that all Subcontractors comply with Sections 1770, 1771, 1772, 1773, 1774, and 1775 of the State of California Labor Code. Compliance with these sections is required by this Contract.

14.3.3 The State of California Department of Industrial Relations has ascertained the general prevailing per diem wage rates in the locality in which the Work is to be performed for each craft, classification, or type of worker required to perform the Work. A copy of the general prevailing per diem wage rates will be on file at University's principal facility office and will be made available to any interested party upon request. Contractor shall post a copy of the general prevailing per diem wage rates at the job site. By this reference, such schedule is made part of the Contract Documents. Contractor shall pay not less than the

prevailing wage rates, as specified in the schedule and any amendments thereto, to all workers employed by Contractor in the execution of the Work. Contractor shall cause all subcontracts to include the provision that all Subcontractors shall pay not less than the prevailing rates to all workers employed by such Subcontractors in the execution of the Work. Contractor shall forfeit to University, as a penalty, not more than \$200 for each calendar day or portion thereof for each worker that is paid less than the prevailing rates as determined by the Director of Industrial Relations for the work or craft in which the worker is employed for any portion of the Work done by Contractor or any Subcontractor. The amount of this penalty shall be determined pursuant to applicable law. Such forfeiture amounts may be deducted from the Contract Sum or sought directly from the surety under its Performance Bond if there are insufficient funds remaining in the Contract Sum. Contractor shall also pay to any worker who was paid less than the prevailing wage rate for the work or craft for which the worker was employed for any portion of the Work, for each day, or portion thereof, for which the worker was paid less than the specified prevailing per diem wage rate, an amount equal to the difference between the specified prevailing per diem wage rate and the amount which was paid to the worker. Review of any civil wage and penalty assessment shall be made pursuant to section 1742 of the California Labor Code.

14.4 PAYROLL RECORDS

14.4.1 For purposes of this Article 14.4, the term Subcontractor shall not include suppliers, manufacturers, or distributors.

14.4.2 Contractor and all Subcontractors shall keep an accurate payroll record, showing the name, address, social security number, job classification, straight time and overtime hours worked each day and week, and the actual per diem wages paid to each journeyworker, apprentice, worker, or other employee employed in connection with the Work. All payroll records shall be certified as being true and correct by Contractor or Subcontractors keeping such records; and the payroll records shall be available for inspection at all reasonable hours at the principal office of Contractor on the following basis:

- .1 A certified copy of an employee's payroll record shall be made available for inspection or furnished to such employee or the employee's authorized representative on request.
- .2 A certified copy of all payroll records shall be made available for inspection upon request to University, the State of California Division of Labor Standards Enforcement, and the Division of Apprenticeship Standards of the State of California Division of Industrial Relations.
- .3 A certified copy of all payroll records shall be made available upon request by the public for inspection or copies thereof made; provided, however, that the request by the public shall be made to either University, the Division of Apprenticeship Standards, or the Division of Labor Standards Enforcement. The public shall not be given access to such records at the principal offices of Contractor or Subcontractors. Any copy of the records made available for inspection as copies and furnished upon request to the public or any public agency by University shall be marked or obliterated in such a manner as to prevent disclosure of an individual's name, address, and social security number. The name and address of Contractor awarded the Contract or performing the Contract shall not be marked or obliterated.

14.4.3 Contractor shall file a certified copy of the payroll records with the entity that requested the records within 10 days after receipt of a written request. Contractor shall inform University of the location of such payroll records for the Project, including the street address, city, and county; and Contractor shall, within 5 working days, provide notice of change of location of such records. In the event of noncompliance with the requirements of this Article 14.4 or with the State of California Labor Code Section 1776, Contractor shall have 10 days in which to comply following receipt of notice specifying in what respects Contractor must comply. Should noncompliance still be evident after the 10 day period, Contractor shall forfeit to University, as a penalty, \$100 for each day, or portion thereof, for each worker, until strict

compliance is accomplished. Such forfeiture amounts may be deducted from the Contract Sum.

14.5 APPRENTICES

14.5.1 For purposes of this Article 14.5, the term Subcontractor shall not include suppliers, manufacturers, and distributors.

14.5.2 Only apprentices, as defined in the State of California Labor Code Section 3077, who are in training under apprenticeship standards and written apprentice agreements under Chapter 4, Division 3, of the State of California Labor Code, are eligible to be employed by Contractor and Subcontractors as apprentices. The employment and training of each apprentice shall be in accordance with the provisions of the apprenticeship standards and written apprentice agreements under which the apprentice is training.

14.5.3 Every apprentice shall be paid the standard wage to apprentices, under the regulations of the craft or trade at which the apprentice is employed, and shall be employed only at the Work in the craft or trade to which the apprentice is indentured.

14.5.4 When Contractor or Subcontractors employ workers in any apprenticeship craft or trade on the Work, Contractor or Subcontractors shall 1) send contract award information to the applicable joint apprenticeship committee that can supply apprentices to the site of the public work and 2) apply to the joint apprenticeship committee, which administers the apprenticeship standards of the craft or trade in the area of the Project site, for a certificate approving Contractor or Subcontractors under the apprenticeship standards for the employment and training of apprentices in the area of the Project site. The committee will issue a certificate fixing the number of apprentices or the ratio of apprentices to journeypersons who shall be employed in the craft or trade on the Work. The ratio will not exceed that stipulated in the apprenticeship standards under which the joint apprenticeship committee operates; but in no case shall the ratio be less than 1 hour of apprentice work for every 5 hours of journeyperson work, except as permitted by law. Contractor or Subcontractors shall, upon the issuance of the approval certificate in each such craft or trade, employ the number of apprentices or the ratio of apprentices to journeypersons fixed in the certificate issued by the joint apprenticeship committee or present an exemption certificate issued by the Division of Apprenticeship Standards.

14.5.5 "Apprenticeship craft or trade," as used in this Article 14.5, shall mean a craft or trade determined as an apprenticeship occupation in accordance with rules and regulations prescribed by the Apprenticeship Council.

14.5.6 If Contractor or Subcontractors employ journeymen or apprentices in any apprenticeship craft or trade in the area of the Project site, and there exists a fund for assisting to allay the cost of the apprenticeship program in the trade or craft, to which fund or funds other contractors in the area of the Project site are contributing, Contractor and Subcontractors shall contribute to the fund or funds in each craft or trade in which they employ journeymen or apprentices on the Work in the same amount or upon the same basis and in the same manner done by the other contractors. Contractor may include the amount of such contributions in computing its bid for the Contract; but if Contractor fails to do so, it shall not be entitled to any additional compensation therefor from University.

14.5.7 In the event Contractor willfully fails to comply with this Article 14.5, it will be considered in violation of the requirements of the Contract.

14.5.8 Nothing contained herein shall be considered or interpreted as prohibiting or preventing the hiring by Contractor or Subcontractors of journeyworker trainees who may receive on-the-job training to enable them to achieve journeyworker status in any craft or trade under standards other than those set forth for apprentices.

14.6 WORK DAY

14.6.1 Contractor shall not permit any worker to labor more than 8 hours during any 1 day or more than 40 hours during any 1 calendar week, except as permitted by law and in such cases only upon such conditions as are provided by law. Contractor shall forfeit to University, as a penalty, \$25 for each worker employed in the execution of this Contract by Contractor, or any Subcontractor, for each day during which such worker is required or permitted to work more than 8 hours in any 1 day and 40 hours in any 1 calendar week in violation of the terms of this Article 14.6 or in violation of the provisions of any law of the State of California. Such forfeiture amounts may be deducted from the Contract Sum. Contractor and each Subcontractor shall keep, or cause to be kept, an accurate record showing the actual hours worked each day and each calendar week by each worker employed on the Project, which record shall be kept open at all reasonable hours to the inspection of University, its officers and agents, and to the inspection of the appropriate enforcement agency of the State of California.

ARTICLE 15 MISCELLANEOUS PROVISIONS

15.1 GOVERNING LAW

15.1.1 The Contract shall be governed by the law of the State of California.

15.2 SUCCESSORS AND ASSIGNS

15.2.1 University and Contractor respectively bind themselves and their successors, permitted assigns, and legal representatives to the other party and to the successors, permitted assigns, and legal representatives of such other party in respect to covenants, agreements, and obligations contained in the Contract Documents. Neither party to the Contract shall assign the Contract, in whole or in part, without prior written consent of the other party. Notwithstanding any such assignment, each of the original contracting parties shall remain legally responsible for all of its obligations under the Contract.

15.3 RIGHTS AND REMEDIES

15.3.1 All University's rights and remedies under the Contract Documents will be cumulative and in addition to and not in limitation of all other rights and remedies of University under the Contract Documents or otherwise available at law or in equity.

15.3.2 No action or failure to act by University or University's Representative will constitute a waiver of a right afforded them under the Contract, nor will such action or failure to act constitute approval of or acquiescence in a condition or breach thereunder, except as may be specifically agreed in writing. No waiver by University or University's Representative of any condition, breach or default will constitute a waiver of any other condition, breach or default; nor will any such waiver constitute a continuing waiver.

15.3.3 No provision contained in the Contract Documents shall create or give to third parties any claim or right of action against University, University's Representative, or Contractor.

15.4 SURVIVAL

15.4.1 The provisions of the Contract which by their nature survive termination of the Contract or Final Completion, including all warranties, indemnities, payment obligations, and University's right to audit Contractor's books and records, shall remain in full force and effect after Final Completion or any termination of the Contract.

15.5 COMPLETE AGREEMENT

15.5.1 The Contract Documents constitute the full and complete understanding of the parties and supersede any previous agreements or understandings, oral or written, with respect to the subject matter hereof. The Contract may be modified only by a written instrument signed by both parties or as provided in

Article 7.

15.6 SEVERABILITY OF PROVISIONS

15.6.1 If any one or more of the provisions contained in the Contract Documents should be invalid, illegal, or unenforceable in any respect, the validity, legality, and enforceability of the remaining provisions contained herein shall not in any way be affected or impaired thereby.

15.7 UNIVERSITY'S RIGHT TO AUDIT

15.7.1 University and entities and agencies designated by University will have access to and the right to audit and the right to copy at University's cost all of Contractor's books, records, contracts, correspondence, instructions, drawings, receipts, vouchers, purchase orders, and memoranda relating to the Work. Contractor shall preserve all such records and other items during the performance of the Contract and for a period of at least 3 years after Final Completion.

15.8 METHODS OF DELIVERY FOR SPECIFIED DOCUMENTS

15.8.1 The following documents must be delivered in a manner specified in Article 15.8.2:

- .1 Contractor Notices of election to litigate or arbitrate;
- .2 Written demand for a final decision by University's Representative pursuant to Article 4.2.5;
- .3 Contractor claims pursuant to Article 4.3;
- .4 Contractor notices of conditions pursuant to Articles 3.17, 3.18, or 3.19;
- .5 University's notices of Contractor's failure to perform and/or correct defective work pursuant to Articles 4.1.6, 12.2 and 13.2.3;
- .6 University's notice to stop work pursuant to Article 2.3.1;
- .7 Notices of termination or suspension pursuant to Article 13.

15.8.2 Delivery methods for documents specified in Article 15.8.1:

- .1 By personal delivery.
- .2 Sent by facsimile copy where receipt is confirmed.
- .3 Sent by Express Mail, or another method of delivery providing for overnight delivery where receipt is confirmed.
- .4 Sent by registered or certified mail, postage prepaid, return receipt requested.

15.8.3 The documents identified in Article 15.8.1 shall only be effective if delivered in the manner specified in Article 15.8.2. Subject to the forgoing, such documents shall be deemed given and received upon actual receipt in the case of all except registered or certified mail; and in the case of registered or certified mail, on the date shown on the return receipt or the date delivery during normal business hours was attempted. Delivery of the specified documents shall be made at the respective street addresses set forth in the Agreement. Such street addresses may be changed by notice given in accordance with this Article 15.8.

15.9 TIME OF THE ESSENCE

15.9.1 Time limits stated in the Contract Documents are of the essence of the Contract.

15.10 MUTUAL DUTY TO MITIGATE

15.10.1 University and Contractor shall use all reasonable and economically practicable efforts to mitigate

LAZY K RESTORATION
UNIVERSITY OF CALIFORNIA MERCED
MERCED, CALIFORNIA

PROJECT NO.: **660175 1B 19900**

delays and damages to the Project and to one another with respect to the Project, regardless of the cause of such delay or damage.

SUPPLEMENTARY CONDITIONS

1. MODIFICATION OF GENERAL CONDITIONS, ARTICLE 3 – CONTRACTOR

Article 3.13.2 is replaced as follows:

3.13.2 Contractor shall, on a daily basis during performance of the Work, keep the Project site and surrounding area free from the accumulation of dirt, waste materials, and rubbish caused by Contractor. If cleanup is not performed on a daily basis, University may perform cleanup as necessary, and allocate the cost for such cleanup between those firms responsible. Contractor shall remove all dirt, waste material, and rubbish caused by Contractor, along with any tools, equipment, machinery, and surplus materials from the Project site and surrounding area at the completion of the Work. Cleanup of unclean jobsite conditions must be within 24 hours after such notice has been given to Contractor by University's Representative.

The following article is added to Article 3 of the General Conditions:

3.22 DAILY REPORTS

3.22.1 Contractor shall submit daily reports, on the form contained in the Exhibits, to the University's Representative not later than 2:00 p.m. each work day.

2. MODIFICATION OF GENERAL CONDITIONS, ARTICLE 3 – CONTRACTOR

Article 3.8.4 is replaced as follows:

3.8. SUPERINTENDENT

3.8.4 The Superintendent may perform the Work of any trade, pickup materials, or perform any Work not directly related to the supervision and coordination of the Work at the Project site when Work is in progress.

3. MODIFICATION OF GENERAL CONDITIONS, ARTICLE 7 - CHANGES IN THE WORK

The following article is added to Article 7 of the General Conditions:

7.7. LETTER OF INSTRUCTION

7.7.1 The University's Representative may issue Letter of Instruction (as shown in Exhibit 26) which make interpretations or clarifications of the Contract Documents that do not change the scope of Work or involve an adjustment of the Contract Sum or the Contract Time and that are consistent with the intent of the Contract Documents. Letter of Instruction shall be binding upon Contractor. Contractor shall promptly carry out the requirements of such Letter of Instruction.

4. MODIFICATION OF GENERAL CONDITIONS, ARTICLE 8 - CONTRACT TIME

8.4.1.6.11 "Rainy weather", but only for such days of rain that are in excess of the number of days specified:

October – 1 day
November – 2 days
December -3 days
January – 5 days
February - 6 days
March – 5 days
April – 3 days
May – September – 0 days

In order for a day to be considered a "day of rainy weather" for the purpose of determining whether Contractor is entitled to a time extension, all of the following conditions must be met:

.3 the Contractor must have employed all reasonable rain mitigation measures to enable the work to continue on the day; and

.4 all other conditions of Article 8 must be met.

When the total number of rainy weather days within a month does not exceed the number of days specified; the remaining days shall carry forward to the next month of the project. Remaining rain days for the calendar year shall carry forward to the next calendar year through final completion of the project.

4. MODIFICATION OF GENERAL CONDITIONS, ARTICLE 9 – PAYMENTS AND COMPLETION

Article 9.4.1 is replaced as follows:

9.4 CERTIFICATE FOR PAYMENT

9.4.1 If Contractor has submitted an Application For Payment in accordance with Article 9.3, University's Representative shall, not later than 10 working days after the date of receipt of the Application For Payment, issue to University, with a copy to Contractor, a Certificate For Payment for such amount as University's Representative determines to be properly due.

MODIFICATION OF GENERAL CONDITIONS, ARTICLE 11 - INSURANCE AND BONDS

Insurance required by Paragraphs 11.1.2.1 and 11.1.2.2 shall be (i) issued by companies with a Best rating of A- or better, and a financial classification of VIII or better (or an equivalent rating by Standard & Poor or Moody's) or (ii) guaranteed, under terms consented to by the University (such consent to not be unreasonably withheld), by companies with a Best rating of A- or better, and a financial classification of VIII or better (or an equivalent rating by Standard & Poor or Moody's). Such insurance shall be written for not less than the following:

	<u>Minimum Requirement</u>
11.1.2.1 Commercial Form General Liability Insurance-Limits of Liability	
Each Occurrence-Combined Single Limit for Bodily Injury and Property	\$1,000,000
Products-Completed Operations Aggregate	\$2,000,000
Personal and Advertising Injury	\$1,000,000
General Aggregate	\$2,000,000
11.1.2.2 Business Automobile Liability Insurance-Limits of Liability	
Each Accident-Combined Single Limit for Bodily Injury and Property Damage	\$2,000,000

Insurance required by Paragraph 11.1.2.3 shall be issued by companies (i) that have a Best rating of B+ or better, and a financial classification of VIII or better (or an equivalent rating by Standard & Poor or Moody's); or (ii) that are acceptable to the University. Such insurance shall be written for not less than the following:

11.1.2.3 WORKER'S COMPENSATION AND EMPLOYER'S LIABILITY – (as required by

Insurance required by Paragraphs 11.1.2.1 and 11.1.2.2 shall be (i) issued by companies with a Best rating of A- or better, and a financial classification of VIII or better (or an equivalent rating by Standard & Poor or Moody's) or (ii) guaranteed, under terms consented to by the University (such consent to not be unreasonably withheld), by companies with a Best rating of A- or better, and a financial classification of VIII or better (or an equivalent rating by Standard & Poor or Moody's). Such insurance shall be written for not less than the following:

Minimum Requirement

Federal and State of California law).

EXHIBITS TABLE OF CONTENTS

Exhibit 1	Certificate of Insurance
Exhibit 2	Payment Bond
Exhibit 3	Performance Bond
Exhibit 4	Application for Payment
Exhibit 5A	Selection of Retention Options
Exhibit 5B	Escrow Agreement for Deposit of Securities In Lieu of Retention and Deposit of Retention
Exhibit 6	Submittal Schedule
Exhibit 7	Cost Proposal
Exhibit 8	Field Order
Exhibit 9	Change Order/Contract Amendment
Exhibit 10	Conditional Waiver and Release Upon Progress Payment
Exhibit 10A	Conditional Waiver and Release Upon Final Payment
Exhibit 11	Unconditional Waiver and Release Upon Progress Payment
Exhibit 11A	Unconditional Waiver and Release Upon Final Payment
Exhibit 12	Summary of Builder's Risk Insurance Policy
Exhibit 13A	Report of Subcontractor Information
Exhibit 13B	Final Distribution of Contract Dollars
Exhibit 14	Self-Certification
Exhibit 15	Certificate of Substantial Completion
Exhibit 16	Guarantee/Warranty Form
Exhibit 17	Request for Information
Exhibit 18	Utility Service Interruption/Shut Down Request – N/A
Exhibit 19	Storm Water Discharge Permit Form – N/A
Exhibit 20	Automatic Sprinkler System – General Contractor's Material & Test Certificate for Aboveground Piping – N/A
Exhibit 21	Automatic Sprinkler System – General Contractor's Material & Test Certificate for Underground Piping – N/A
Exhibit 22	Material Substitution Proposal
Exhibit 23	Material Submittal Approval Form
Exhibit 24	Waste Management Plan – N/A
Exhibit 25	Waste Management Progress Report – N/A
Exhibit 26	Letter of Instruction
Exhibit 27	General Contractor Claim Certification
Exhibit 28	Subcontractor Claim Certification
Exhibit 29	Subcontractor Daily Report
Exhibit 30	Welding/Hot Work Permit
Exhibit 31	Inspection/Testing Request – N/A
Exhibit 40	LEED Documentation Sheet – N/A
Exhibit 41	LEED Score Card – N/A
Exhibit 50	Drawing List

EXHIBIT 1 – CERTIFICATE OF INSURANCE

DATE ISSUED: _____

BROKER/AGENT	COMPANIES AFFORDING COVERAGE	
	COMPANY A	
	COMPANY B	
NAMED INSURED	COMPANY C	
	COMPANY D	

COVERAGES

This is to certify that policies of insurance listed below have been issued to the insured named above for the policy period indicated. This certificate or verification of insurance is not an insurance policy and does not amend, extend or alter the coverage afforded by the policies listed herein. Notwithstanding any requirement, term or condition of any contract or other document with respect to which this certificate or verification of insurance may be issued or may pertain, the insurance afforded by the policies described herein is subject to all the terms, exclusions and conditions of such policies.

CO LTR	TYPE OF INSURANCE	POLICY NUMBER	POLICY EFF. DATE (M/D/Y)	POLICY EXP. DATE (M/D/Y)		LIMITS	DEDUCTIBLE
	GENERAL LIABILITY <input type="checkbox"/> COMMERCIAL FORM <input type="checkbox"/> CLAIMS MADE <input type="checkbox"/> OCCURRENCE <input type="checkbox"/> SEVERABILITY OF INTEREST CLAUSE <input type="checkbox"/> CROSS LIABILITY CLAUSE					GENERAL AGGREGATE \$ PRODUCTS/COMPLETED OPERATIONS AGGREGATE \$ PERSONAL & ADVERTISING INJURY \$ EACH OCCURRENCE \$ FIRE DAMAGE (ANY ONE FIRE) \$ MEDICAL EXPENSE (ANY ONE PERSON) \$	\$
	AUTOMOBILE LIABILITY <input type="checkbox"/> ANY AUTO (CODE 1) <input type="checkbox"/> ALL OWNED AUTOS (CODE 2) <input type="checkbox"/> SCHEDULED AUTOS (CODE 7) <input type="checkbox"/> HIRED AUTOS (CODE 8) <input type="checkbox"/> NON-OWNED AUTOS (CODE 9) <input type="checkbox"/> OTHER					CSL \$ BODILY INJURY (PER PERSON) \$ BODILY INJURY (PER ACCIDENT) \$ PROPERTY DAMAGE \$	\$
	EXCESS LIABILITY <input type="checkbox"/> UMBRELLA FORM <input type="checkbox"/> OTHER <input type="checkbox"/> CLAIMS MADE OCCURRENCE					EACH OCCURRENCE \$ AGGREGATE \$	
	PROFESSIONAL LIABILITY* <input type="checkbox"/> CLAIMS MADE <input type="checkbox"/> OCCURRENCE					EACH OCCURRENCE \$ AGGREGATE \$	
	WORKERS' COMPENSATION AND EMPLOYERS' LIABILITY*					AS REQUIRED BY FEDERAL AND CALIFORNIA LAW	

SPECIAL PROVISIONS:
 *Special Provision #1 and #2 below do not apply to this coverage.

- THE REGENTS OF THE UNIVERSITY OF CALIFORNIA, ITS OFFICERS, AGENTS, EMPLOYEES, CONSULTANTS, REPRESENTATIVES, AND REPRESENTATIVE'S CONSULTANTS ARE INCLUDED AS ADDITIONAL INSURERS BUT ONLY IN CONNECTION WITH **Lazy K Restoration**
- THIS INSURANCE SHALL BE PRIMARY INSURANCE AS RESPECTS THE REGENTS OF THE UNIVERSITY OF CALIFORNIA, ITS OFFICERS, AGENTS, AND EMPLOYEES. ANY INSURANCE OR SELF-INSURANCE MAINTAINED BY THE REGENTS OF THE UNIVERSITY OF CALIFORNIA SHALL BE EXCESS OF AND NONCONTRIBUTORY WITH THIS INSURANCE.
- THE PROVISIONS UNDER PARAGRAPHS (1&2) OF THIS SECTION, "SPECIAL PROVISIONS", SHALL APPLY TO CLAIMS, COSTS, INJURIES OR DAMAGES BUT ONLY IN PROPORTION TO AND TO THE EXTENT SUCH CLAIMS, COSTS, INJURIES, OR DAMAGES ARE CAUSED BY OR RESULT FROM THE NEGLIGENT ACTS OR OMISSIONS OF THE NAMED INSURED.
- SHOULD ANY OF THE INSURANCE PROGRAMS DESCRIBED HEREIN BE MATERIALLY MODIFIED OR CANCELED BEFORE THE EXPIRATION DATE THEREOF, THE ISSUING COMPANY WILL MAIL THIRTY (30) DAYS (TEN [10] DAYS FOR NON-PAYMENT OF PREMIUM) WRITTEN NOTICE TO THE CERTIFICATE HOLDER NAMED BELOW.

CERTIFICATE HOLDER: THE REGENTS OF THE UNIVERSITY OF CALIFORNIA. FORWARD TO: Design & Construction UNIVERSITY OF CALIFORNIA, MERCED 5200 N. Lake Rd Merced, CA 95343	THE UNDERSIGNED CERTIFIES THAT HE/SHE IS AUTHORIZED TO SIGN THIS CERTIFICATE AND THAT THE SPECIAL PROVISIONS DESCRIBED HEREIN HAVE BEEN MADE A PART OF THE POLICY(IES) SHOWN ABOVE. _____ AUTHORIZED REPRESENTATIVE
---	---

Bond No.: _____

PAYMENT BOND

KNOW ALL PERSONS BY THESE PRESENTS:

THAT WHEREAS, The Regents of the University of California ("The Regents") has awarded to _____ as Principal a contract dated the _____ day of _____, 20 (the "Contract") for the work described as follows:

**LAZY K RESTORATION
UNIVERSITY OF CALIFORNIA MERCED CAMPUS
MERCED COUNTY, MERCED CALIFORNIA**

AND WHEREAS, Principal is required to furnish a bond in connection with the Contract to secure the payment of claims of laborers, mechanics, material suppliers, and other persons as provided by law;

NOW, THEREFORE, we, the undersigned Principal and _____ as Surety, are held and firmly bound unto The Regents in the sum of \$ _____ for which payment well and truly to be made we bind ourselves, our heirs, executors, administrators, successors, and assigns, jointly and severally, firmly by these presents.

THE CONDITION OF THIS OBLIGATION IS SUCH, that if Principal, or its heirs, executors, administrators, successors, or assigns approved by The Regents, or its subcontractors shall fail to pay any of the persons named in State of California Civil Code Section 3181, or amounts due under the State of California Unemployment Insurance Code with respect to work or labor performed under the Contract, or for any amounts required to be deducted, withheld, and paid over to the State of California Employment Development Department from the wages of employees of Principal and subcontractors pursuant to Section 13020 of the State of California Unemployment Insurance Code with respect to such work and labor, that Surety will pay for the same in an amount not exceeding the sum specified in this bond, otherwise the above obligation shall become and be null and void.

This bond shall inure to the benefit of any of the persons named in State of California Civil Code Section 3181 as to give a right of action to such persons or their assigns in any suit brought upon this bond.

Surety, for value received, hereby expressly agrees that no extension of time, change, modification, alteration, deletion, or addition to the undertakings, covenants, terms, conditions, and agreements of the Contract, or to the work to be performed thereunder, shall in any way affect the obligation of this bond; and it does hereby waive notice of any such extension of time, change, modification, alteration, deletion, or addition to the undertakings, covenants, terms, conditions, and agreements of the Contract, or to the work to be performed thereunder.

Surety's obligations hereunder are independent of the obligations of any other surety for the payment of claims of laborers, mechanics, material suppliers, and other persons in connection with the Contract; and suit may be brought against Surety and such other sureties, jointly and severally, or against any one or more of them, or against less than all of them without impairing The Regents' rights against the others.

In the event suit is brought upon this bond, the parties not prevailing in such suit shall pay reasonable attorneys' fees and costs incurred by the prevailing parties in such suit.

Correspondence or claims relating to this bond shall be sent to Surety at the address set forth below.

IN WITNESS WHEREOF, we have hereunto set our hands this _____ day of _____, 20 .

Principal: _____
(Name of Firm)

Surety: _____
(Name of Firm)

By: _____
Title: _____

By: _____
Title: _____

Address for Notices:

NOTE: Notary acknowledgement for Surety and Surety's Power of Attorney must be attached.

Bond No.: _____

PERFORMANCE BOND

KNOW ALL PERSONS BY THESE PRESENTS:

THAT WHEREAS, The Regents of the University of California ("The Regents") has awarded to _____ as Principal a contract dated the _____ day of _____, 20 (the "Contract"), which Contract is by this reference made a part hereof, for the work described as follows:

**LAZY K RESTORATION
UNIVERSITY OF CALIFORNIA MERCED CAMPUS
MERCED COUNTY, MERCED CALIFORNIA**

AND WHEREAS, Principal is required to furnish a bond in connection with the Contract, guaranteeing the faithful performance thereof;

NOW, THEREFORE, we, the undersigned Principal and _____ as Surety are held and firmly bound unto The Regents in the sum of \$ _____, to be paid to The Regents or its successors and assigns; for which payment, well and truly to be made, we bind ourselves, our heirs, executors, administrators, successors, and assigns, jointly and severally, firmly by these presents.

THE CONDITION OF THIS OBLIGATION IS SUCH, that if Principal, or its heirs, executors, administrators, successors, or assigns approved by The Regents, shall promptly and faithfully perform the covenants, conditions, and agreements of the Contract during the original term and any extensions thereof as may be granted by The Regents, with or without notice to Surety, and during the period of any guarantees or warranties required under the Contract, and shall also promptly and faithfully perform all the covenants, conditions, and agreements of any alteration of the Contract made as therein provided, notice of which alterations to Surety being hereby waived, on Principal's part to be kept and performed at the time and in the manner therein specified, and in all respects according to their true intent and meaning, and shall indemnify, defend, protect, and hold harmless The Regents as stipulated in the Contract, then this obligation shall become and be null and void; otherwise it shall be and remain in full force and effect.

No extension of time, change, alteration, modification, or addition to the Contract, or of the work required thereunder, shall release or exonerate Surety on this bond or in any way affect the obligation of this bond; and Surety does hereby waive notice of any such extension of time, change, alteration, modification, or addition.

Whenever Principal shall be and declared by The Regents to be in default under the Contract, Surety shall promptly remedy the default, or shall promptly:

1. Undertake through its agents or independent contractors, reasonably acceptable to The Regents, to complete the Contract in accordance with its terms and conditions and to pay and perform all obligations of Principal under the Contract, including without limitation, all obligations with respect to warranties, guarantees, and the payment of liquidated damages, or, at Surety's election, or, if required by The Regents.

2. Obtain a bid or bids for completing the Contract in accordance with its terms and conditions, and, upon determination by The Regents of the lowest responsible bidder, arrange for a contract between such bidder and The Regents and make available as work progresses (even though there should be a default or a succession of defaults under the contract or contracts of completion arranged under this paragraph) sufficient funds to pay the cost of completion less the balance of the Contract Sum, and to pay and perform all obligations of Principal under the Contract, including, without limitation, all obligations with respect to warranties, guarantees, and the payment of liquidated damages; but, in any event, Surety's total obligations hereunder shall not exceed the amount set forth in the third paragraph hereof. The term "balance of the Contract Sum," as used in this paragraph, shall mean the total amount payable by The Regents to the Principal under the Contract and any amendments thereto, less the amount paid by The Regents to Principal.

Surety's obligations hereunder are independent of the obligations of any other surety for the performance of the Contract, and suit may be brought against Surety and such other sureties, jointly and severally, or against any one or more of them, or against less than all of them without impairing The Regents' rights against the others.

No right of action shall accrue on this bond to or for the use of any person or corporation other than The Regents or its successors or assigns.

Surety may join in any arbitration proceedings brought under the Contract and shall be bound by any arbitration award.

In the event suit is brought upon this bond by The Regents, Surety shall pay reasonable attorney's fees and costs incurred by The Regents in such suit.

Correspondence or claims relating to this bond shall be sent to Surety at the address set forth below.

IN WITNESS WHEREOF, we have hereunto set our hands this _____ day of _____, 20 .

Principal: _____ Surety: _____
(Name of Firm) (Name of Firm)

By: _____ By: _____

Title: _____ Title: _____

Address for Notices:

NOTE: Notary acknowledgement for Surety and Surety's Power of Attorney must be attached.

APPLICATION FOR PAYMENT

Number: _____ Period to: _____

TO UNIVERSITY: THE REGENTS OF THE UNIVERSITY OF CALIFORNIA, MERCED, UNIVERSITY OF CALIFORNIA, 5200 N. LAKE ROAD, MERCED, CA 95344 AND UNIVERSITY'S REPRESENTATIVE:

FROM CONTRACTOR: _____
ADDRESS: _____
PROJECT NAME: LAZY K RESTORATION
PROJECT NUMBER: 661075 1B 19900
FACILITY: University of California, Merced
CONTRACT DATE: _____
APPLICATION DATE: _____

<u>CHANGE ORDER SUMMARY:</u>	<u>Additions</u>	<u>Deductions</u>
Change Orders approved in previous months: Total:	_____	_____
Change Orders approved this month:		
Number: Date Approved:		
_____	_____	_____
_____	_____	_____
_____	_____	_____
Total:	_____	_____

NET CHANGE BY CHANGE ORDERS: _____

Application is made for payment under the Contract as shown below and in Schedule 1 attached hereto:

1. ORIGINAL CONTRACT SUM		\$ _____
2. NET CHANGE BY CHANGE ORDERS		\$ _____
3. CONTRACT SUM TO DATE (Line 1 ± Line 2)		\$ _____
4. TOTAL AMOUNT COMPLETED TO DATE (Column E on Schedule 1)	\$ _____	
5. RETENTION: 5% of Completed Work (Column H on Schedule 1)*	\$ _____	
a. Current Value of Securities Deposited in Escrow	\$ _____	
b. Current Value of Retention Deposited in Escrow	\$ _____	
c. Retention Held by University	\$ _____	
Current Retention Value (a + b + c)	\$ _____	
6. TOTAL EARNED LESS RETENTION (Line 4 less Line 5)		\$ _____
7. TOTAL AMOUNT PREVIOUSLY PAID	\$ _____	
8. CURRENT PAYMENT DUE (Line 6 less Line 7)		\$ _____
9. BALANCE TO FINISH, PLUS RETENTION (Line 3 less Line 6)	\$ _____	

*Pursuant to Article 9.2.2 of the General Conditions.

The undersigned Contractor hereby represents and warrants to University that all Work, for which Certificates For Payment have previously been issued and payment received from University, is free and clear of all claims, stop notices, security interests, and encumbrances in favor of Contractor, any Subcontractor, and any other persons or firms entitled to make claims by reason of having provided labor, materials, or equipment related to the Work.

The following Schedules are attached and incorporated herein, and made a part of this Application For Payment:

- Schedule 1 Cost Breakdown Schedule
- Schedule 2 Certification of Current Market Value of Securities in Escrow in Lieu of Retention
- Schedule 3 List of Subcontractors
- Schedule 4 Declaration of Releases of Claims

(Contractor)

By: _____
(Name)

(Title)

DECLARATION

I, _____, hereby declare that I am the _____ of Contractor submitting this Application For Payment; that I am duly authorized to execute and deliver this Application For Payment on behalf of Contractor; and that all information set forth in this Application For Payment and all Schedules attached hereto are true, accurate, and complete as of its date.

I declare, under penalty of perjury, that the foregoing is true and correct and that this declaration was subscribed at

_____, _____, State of _____

on _____, 20__.

(Signature)

(Print Name)

LAZY K RESTORATION
 UNIVERSITY OF CALIFORNIA MERCED
 MERCED, CALIFORNIA

PROJECT NO.: 660175 1B 19900

PROJECT NAME: _____

APPLICATION NUMBER: _____

PROJECT NUMBER: _____

APPLICATION DATE: _____

FACILITY: University of California, Merced

PERIOD TO: _____

CONTRACT DATE: _____

CONTRACTOR: _____

SCHEDULE 1
 TO
 APPLICATION FOR PAYMENT
 COST BREAKDOWN

<u>A</u>	<u>B</u>	<u>C</u>	<u>D</u>	<u>E</u>	<u>F</u>	<u>G</u>	<u>H</u>
ITEM NO.	DESCRIPTION OF WORK ACTIVITY OR OTHER ITEM	SCHEDULED VALUE	% COMPLETE TO DATE	TOTAL AMOUNT COMPLETED TO DATE (C x D)	TOTAL AMOUNT COMPLETED ON PRIOR APPLICATION FOR PAYMENT	AMOUNT OF THIS APPLICATION (E - F)	RETENTION (5% x E)
001	Bonds/Insurance						
002	Mobilization						
003	Submittals						
004	Shop Drawings						
005							
006	As-built Update						
007	Closeout Documents						
008	Punchlist						
009	Warranty						
010	Commissioning/ Start Up						

PROJECT NAME: _____

CONTRACTOR: _____

PROJECT NUMBER: _____

APPLICATION NUMBER: _____

SCHEDULE 2
TO
APPLICATION FOR PAYMENT

CERTIFICATION OF CURRENT MARKET VALUE
OF SECURITIES IN ESCROW IN LIEU OF RETENTION

As of _____, 20__ (not earlier than 5 days prior to the date of the Application For Payment of which this certification is a part), the aggregate market value of securities on deposit in Escrow

Account No. _____ with _____
(Escrow Agent)

is _____ Dollars (\$_____).

(Escrow Agent)

(Contractor)

By: _____
(Name)

(Name)

(Title)

(Title)

Date: _____

Date: _____

NOTE: Notary acknowledgment for Contractor and Escrow Agent must be attached.

PROJECT NAME: _____
CONTRACTOR: _____
PROJECT NUMBER: _____
APPLICATION NUMBER: _____

SCHEDULE 3
TO
APPLICATION FOR PAYMENT
LIST OF SUBCONTRACTORS

Subcontractors listed below are all Subcontractors furnishing labor, services, or materials for the period referred to in the Application For Payment referenced above, of which this Schedule 3 is a part:

<u>Name of Subcontractor</u>	<u>Subcontracted Work Activity</u>	<u>Date Work Activity Completed</u>

(Contractor)
By: _____
(Name)

(Title)

Date: _____

PROJECT NAME: _____

CONTRACTOR: _____

PROJECT NUMBER: _____

APPLICATION NUMBER: _____

SCHEDULE 4
TO
APPLICATION FOR PAYMENT

DECLARATION OF RELEASE OF CLAIMS

Contractor hereby certifies that attached hereto are releases and waivers of claims and stop notices from all Subcontractors furnishing labor, services, or materials covered by the Certificate For Payment dated _____, 20____, except those listed below:

(Contractor)

By: _____
(Name)

(Title)

Date: _____

SELECTION OF RETENTION OPTIONS

I (we): _____
(Contractor)

SELECTION OPTION 1

Check here for Option 1

University will withhold retention _____

OR SELECTION OPTION 2

Check here for Option 2

herewith elect to substitute securities in the form of:

(Type of security)

in lieu of retention being withheld by University for the above-referenced project.

OR SELECT OPTION 3

Check here for Option 3

herewith elect to have retention on the above-referenced project paid directly into the Escrow Account.

(Type of Security to be purchased)

An Escrow Account will be opened with**:

(Name of state or federally chartered bank in California)

whose address is:

(Street)

(City, County)

(State, Zip Code)

On Behalf of Contractor*

On Behalf of University Acknowledged and Approved

(Signature)

(Signature)

(Printed Name)

Thomas E. Lollini, FAIA

(Printed Name)

(Title)

Associate Vice Chancellor Design & Construction

(Title)

***Signature shall be by the authorized party who signs the Escrow Agreement for Deposit of Securities in Lieu of Retention and Deposit of Retention ("Escrow Agreement").**

**** Note: Contractor and its surety bear the risk of failure of the bank selected.**

Note: If a completed and signed Escrow Agreement is not submitted with this form, University will not allow deposit of securities in lieu of retention.

RETURN THIS AGREEMENT SIGNED BY CONTRACTOR AND ESCROW AGENT TO: DESIGN AND CONSTRUCTION, UNIVERSITY OF CALIFORNIA, MERCED, 5200 N. Lake RD, MERCED CA 95343.

Escrow Account No.: _____

**ESCROW AGREEMENT FOR
DEPOSIT OF SECURITIES IN LIEU OF RETENTION
AND
DEPOSIT OF RETENTION**

This Escrow Agreement is made as of _____, _____, and entered into by and between THE REGENTS OF THE UNIVERSITY OF CALIFORNIA, whose address is University of California, Office of the President, 1111 Franklin Street, 6th Floor, Oakland, CA 94607-5200, hereinafter called "University," and

_____ ,
whose address is _____ ,

hereinafter called "Contractor," and _____ ,

a state or federally chartered bank in the state of California, whose address is:

_____ ,
hereinafter called "Escrow Agent."

For consideration hereinafter set forth, University, Contractor, and Escrow Agent agree as follows:

(1) Contractor has the option to deposit securities with Escrow Agent as a substitute for retention required to be withheld by University pursuant to the Contract Documents, hereinafter referred to as "Contract," entered into between University and Contractor for the Project titled **LAZY K RESTORATION** in the amount of \$ _____, dated _____. Alternatively, on written request of Contractor, University shall deposit retention directly with Escrow Agent. When Contractor deposits the securities as a substitute for retention, Escrow Agent shall notify University within 5 days after the deposit. At all times, Contractor shall have on deposit securities the market value of which is at least equal to the cash amount then required to be withheld as retention under the terms of the Contract. Securities shall be held in the name of The Regents of the University of California, Merced Campus (Facility); and Contractor shall be designated as the beneficial owner.

(2) Escrow Agent shall review the market value of securities deposited in escrow under this Escrow Agreement as often as conditions of the securities market warrant, but in no case less than once per month. Escrow Agent shall promptly notify University and Contractor of the market value of the deposited securities if such market value is less than the total amount of retention required to be withheld under the terms of the Contract. Contractor shall promptly deposit additional securities so that the current market value of the total of all deposited securities shall be at least equal to the total required amount of retention. Escrow Agent shall, within 5 days after University's request, provide a statement to University of the current market value of all securities deposited under this Escrow Agreement as of a date not earlier than 5 days prior to such request. The provisions of this Paragraph 2 shall not apply to securities consisting of monetary deposits as allowed by Paragraph 7 held by a bank as Escrow Agent, provided the bank provides monthly statements reflecting the status of the monetary deposits held by the bank to University and Contractor.

(3) Contractor shall not use any or all of the securities deposited in lieu of retention under this Escrow Agreement for any other obligations, including deposits in lieu of retention for other contracts. Contractor represents, covenants and warrants that all deposited securities shall be lien free when tendered to the Escrow Agents and shall remain lien free during their retention by the Escrow Agent.

(4) University shall make progress payments to Contractor for those funds which otherwise would be withheld from progress payments pursuant to the Contract provision, provided that Escrow Agent holds

securities in the form and amount specified herein.

(5) Prior to Contractor's submission of each Application For Payment, Escrow Agent shall issue a current statement of (a) the value of the securities currently being deposited in lieu of retention and (b) the current value of all securities being held in escrow pursuant to this Escrow Agreement. Such statement shall be no more than 5 days old at the time of submission, shall be notarized or have a guarantee of signature, and shall be submitted to Contractor with a copy to University under separate cover. Contractor shall attach such original statement to each Application For Payment. The provisions of this Paragraph 5 shall not apply to securities consisting of monetary deposits as allowed by Paragraph 7 held by a bank as Escrow Agent, provided the bank provides monthly statements reflecting the status of the monetary deposits held by the bank to University and Contractor.

(6) If, at the request of Contractor, University deposits retention directly with Escrow Agent, Escrow Agent shall hold such retention for the benefit of Contractor until such time as the escrow created under the Contract is terminated. All terms and conditions of this Escrow Agreement and the rights and responsibilities of the parties shall be equally applicable and binding when University deposits retention directly with Escrow Agent.

(7) University will allow Contractor to deposit the following securities in lieu of retention and direct the investment of the retention deposits into any of the following which at the time of payment are legal investments under the laws of the State of California:

- a. Direct obligations of the United States of America (including obligations issued or held in book-entry form on the books of the Department of the Treasury of the United States of America or any Federal Reserve Bank), or obligations the timely payment of the principal of and interest on which are fully guaranteed by the United States of America, or tax-exempt obligations which are rated in the highest rating category of a nationally recognized bond rating agency.
- b. Obligations, debentures, notes or other evidence of indebtedness issued or guaranteed by any of the following: Banks for Cooperatives, Federal Intermediate Credit Banks, Federal Home Loan Bank System, Export-Import Bank of the United States, Federal Financing Bank, Federal Land Banks, Federal Farm Credits, Government National Mortgage Association, Farmer's Home Administration, Federal Home Loan Mortgage Corporation, or Federal Housing Administration.
- c. Bonds of the State of California or those for which the faith and credit of the State of California are pledged for the payment of principal and interest.
- d. Interest-bearing bankers acceptances and demand or time deposits (including certificates of deposit) in banks, provided such deposits are either (1) secured at all times, in the manner and to the extent provided by law, by collateral security described in clauses a or b of this Paragraph 7 continuously having a market value at least equal to the amount so invested so long as such underlying obligations or securities are in the possession of the Securities Investors Protection Corporation, (2) in banks having a combined capital and surplus of at least One Hundred Million Dollars, or (3) fully insured by the Federal Deposit Insurance Corporation.
- e. Taxable government money market portfolios restricted to obligations with maturities of one (1) year or less, issued or guaranteed as to payment of principal and interest by the full faith and credit of the United States of America.
- f. Commercial paper rated in the highest rating category of a nationally recognized rating agency, and issued by corporations organized and operating within the United States of America and having total assets in excess of Five Hundred Million Dollars.

(8) Contractor shall be responsible for paying all fees, costs, and expenses incurred by Escrow Agent in administering the escrow account. These expenses and payment terms shall be determined by

Contractor and Escrow Agent. All fees, costs, and expenses of this Escrow Agreement and any transactions carried out hereunder shall be billed by Escrow Agent to Contractor. In the event that any fees, costs, or expenses shall remain unpaid in excess of 30 days from the date due, Escrow Agent may withhold such unpaid amount from any income distributable to Contractor, but shall not withhold such unpaid amount from any income distributable to University.

(9) Interest earned on the securities or the money market accounts held in escrow and all interest earned on the interest shall be for the sole account of Contractor and shall be held in escrow. Interest may be withdrawn by Contractor from time to time, without notice to University, only to the extent that the total amount held in escrow meets or exceeds the required amount of retention.

(10) Except as provided in Paragraph 9, Contractor shall have the right to withdraw all or any part of the escrow account only by written notice to Escrow Agent accompanied by written authorization from University to Escrow Agent stating that University consents to the withdrawal of the amount sought to be withdrawn by Contractor. University shall not be obligated to consent to any withdrawal to the extent of stop notice claims which cannot be satisfied from other funds then due and payable to Contractor.

(11) University shall have the right to draw upon the securities, any interest earned on the securities, and any interest earned on the interest in the event of default by Contractor. Upon 7 days written notice to Escrow Agent from University, with a copy to Contractor, Escrow Agent shall immediately convert the securities, any interest earned on the securities, and all interest earned on the interest to cash and shall distribute the cash as instructed by University. Escrow Agent shall have no duty to determine whether a default has occurred and may rely solely upon the written notice of such default from University.

(12) Upon receipt of written notification from University certifying that final payment is due under the Contract, Escrow Agent shall release to Contractor the amount, if any, by which the value of all securities and interest on deposit less escrow fees and charges of the escrow account exceeds 125% of all stop notice claims on file. Escrow Agent shall pay the remaining amount to University or as directed by University. The escrow shall be closed immediately upon disbursement of all monies and securities on deposit and payment of fees and charges.

(13) Escrow Agent shall rely upon the written notifications from University and Contractor pursuant to this Escrow Agreement; and University and Contractor shall hold Escrow Agent harmless from Escrow Agent's release, conversion, and disbursement of the securities and interest as set forth herein.

(14) Escrow Agent shall have the right to terminate this Escrow Agreement upon 30 days notice to all parties hereunder. Upon receipt of such notice, University and Contractor shall appoint a successor Escrow Agent in writing and deliver written notice of such appointment to Escrow Agent. Thereupon, Escrow Agent shall deliver all assets in its custody to such successor Escrow Agent and all responsibility of Escrow Agent under this Escrow Agreement shall terminate; provided, however, if Contractor and University fail to appoint a successor Escrow Agent on or before the end of the 30 day notice period, then Escrow Agent is authorized and instructed to return all assets, documents, and other items in its custody to University and this Escrow Agreement shall be terminated without further instruction.

(15) The duties and responsibilities of Escrow Agent shall be limited to those expressly set forth in this Escrow Agreement; provided, however, that, with Escrow Agent's written consent, the duties and responsibilities in this Escrow Agreement may be amended at any time or times by an instrument in writing signed by all parties.

(16) Whenever Contractor tenders securities to be deposited in lieu of retention, an authorized representative of the Contractor shall declare under penalty of perjury that the securities are lien free and shall remain lien free during their retention by the Escrow Agent. The declaration shall be in the following form:

“The undersigned, on behalf of _____ (Name of Contractor) whose address is _____ (Street Address, City, State, Zip Code) represents, covenants and warrants that the securities tendered herewith are lien free and shall remain lien free during their retention by the Escrow Agent. I, _____ (Name), hereby declare that I am the _____ (Title) of _____ (Name of Contractor), that I am duly authorized to make this representation, and that I declare under perjury under the laws of the State of California that the foregoing is true and correct.”

(Signature)

(Date)

(17) The names of the persons authorized to give written notice or to receive written notice on behalf of University and on behalf of Contractor in connection with this Escrow Agreement, and exemplars of their respective signatures, are as set forth below. Such names may be changed by written notice to the other parties.

On behalf of University:

On behalf of Contractor:

1. Michael Reese, Vice Chancellor for
Business & Administration

(Name)

1. _____
(Name)

(Signature)
(209) 228-4430

(Telephone Number)

(Signature)

(Telephone Number)

2. Dan Feitelberg, Vice Chancellor for
Planning & Budget

(Name)

(Signature)
(209) 228-4070

(Telephone Number)

2. _____
(Name)

(Signature)

(Telephone Number)

Contractor, Escrow Agent, and University hereby agree to the covenants contained herein.

IN WITNESS WHEREOF, Contractor, Escrow Agent, and University have executed this Escrow Agreement, the day and year first written above.

University:

Contractor:

By

By

(Signature)
Michael Reese

(Printed Name)
Vice Chancellor for Business &
Administration Services

(Title)
(209) 228-4430

(Telephone Number)

(Signature)

(Printed Name)

(Title)

(Telephone Number)

By

By

(Signature)
Dan Feitelberg

(Printed Name)
Vice Chancellor for Planning & Budget

(Title)
(209) 228-4070

(Telephone Number)

(Signature)

(Printed Name)

(Title)

(Telephone Number)

Escrow Agent:

By:

(Signature)

(Printed Name)

(Title)

(Telephone Number)

SUBMITTAL SCHEDULE
(Refer to Section 01 33 23 Shop Drawings, Project Data and Samples)

PROJECT NAME: LAZY K RESTORATION
UNIVERSITY OF CALIFORNIA MERCED
MERCED CALIFORNIA

PROJECT NO: 660175 1B 19900

FACILITY: DESIGN & CONSTRUCTION,
UNIVERSITY OF CALIFORNIA, MERCED CAMPUS

CONTRACT DATE: _____

Contractor
/SUBCONTRACTOR: _____

SPECIFICATION
SECTION: _____

WORK ACTIVITY: _____

Event	Scheduled Completion Date	Actual Completion Date	Calendar Days Required to Complete
1. Received by Contractor and Time for Checking			
2. First Delivered to University's Representative and Time for Checking			
3. Return to Contractor			
4. Corrections Completed and Time for Corrections			
5. Next Delivered to University's Representative and Time for Checking			
6. Return to Contractor			
7. Approval for Job Information			
8. Approval for Fabrication and Time for Fabrication			
9. Fabrication Completed			
10. Shipping Date and Time en Route			
11. Delivery to Job			

COST PROPOSAL

Date: _____ Change Request No.: _____

Project Name: LAZY K RESTORATION
UNIVERSITY OF CALIFORNIA MERCED
MERCED, CALIFORNIA

Project No: 660175 1B 19900

Facility: DESGIN & CONSTRUCTION
UNIVERSITY OF CALIFORNIA MERCED
MERCED CALIFORNIA

Contract Date: _____

SCOPE OF CHANGE:

INSTRUCTIONS:

1. Complete this form by providing (a) all information required above, (b) the amount and justification based upon the Contract Schedule for any proposed adjustment of Contract Time, (c) the proposed adjustment of Contract Sum, (d) the attached "Cost Proposal Summary," and (e) the attached form titled, "Supporting Documentation for the Cost Proposal Summary."
2. Attach the form titled "Supporting Documentation for the Cost Proposal Summary" for Contractor and each Subcontractor involved in the Extra Work. Each such form shall be completed and signed by Contractor or Subcontractor actually performing the Work activity identified on the form. Attach supporting data to each such form to substantiate the individually listed costs. The costs provided on these forms shall be used to substantiate Additional Costs shown on the Cost Proposal Summary.
3. The Contractor Fee shall be computed on the Cost of Extra Work of Contractor and each Subcontractor involved in the Extra Work; and shall constitute full compensation for all costs and expenses related to the subject change and not listed in the "Supporting Documentation for the Cost Proposal Summary," including overhead and profit.
4. Refer to Article 7.3 of the General Conditions for the method of computing the Contractor Fee.

Adjustment of the Contract Time (Include justification based upon the Contract Schedule):

Refer to Article 8 of the General Conditions. _____ (Days)

Adjustment of the Contract Sum (Total Additional Cost from Cost Proposal Summary): \$ _____

Refer to Article 7 of the General Conditions.

Submitted: _____
(Contractor)

Received: _____
(University's Representative)

By: _____

By: _____

Title: _____

Title: _____

Date: _____

Date: _____

COST PROPOSAL SUMMARY

Project Name: LAZY K RESTORATION
 UNIVERSITY OF CALIFORNIA MERCED
 MERCED, CALIFORNIA

Project No.: 900165

Facility: University of California, Merced

Change Request No.: _____

Contractor Name: _____

		(1)	(2)	(3)	(4)
		Contractor	1st Tier Subs	2nd & Lower Tier Subs	Total
ACTUAL COSTS	1. Straight Time Wages/Salaries - Labor				
	2. Fringe Benefits and Payroll Taxes - Labor				
	3. Overtime Wages/Salaries - Labor				
	4. Fringe Benefits and Payroll Taxes - Overtime				
	5. Materials and Consumable Items				
	6. Sales Taxes (On line 5)				
	7. Rental Charges				
	8. Royalties				
	9. Permits				
	10. Actual Costs (Sum of lines 1-9)				
	11. Insurance & Bonds (up to 2% of line 10)				
CONTRACTOR FEE	12. Sub-Sub (15% of line 10; col. 3)				
	13. Subcontractor (5% of line 10; col. 3)				
	14. Subcontractor (15% of line 10; col. 2)				
	15. Contractor (5% of line 10; col. 2 & 3)				
	16. Contractor (15% of line 10; col. 1)				
	17. Contractor Fee (Sum of lines 12-16)				
18. Sum of lines 10, 11, & 17					

Actual Costs are taken from line 12 of the attached forms titled, "Supporting Documentation For the Cost Proposal Summary" for Contractor and each Subcontractor involved in the Extra Work.

SUPPORTING DOCUMENTATION FOR THE COST PROPOSAL SUMMARY

Contractor/Subcontractor Name: _____
 Work Activity _____
 Facility _____
 University of California, Merced

Change Order Request No.: _____
 Project No.: _____
 907265

COST ITEM		COST ⁽¹⁾
ACTUAL COSTS	1. Straight Time Wages/Salaries -- Labor	
	2. Fringe Benefits and Payroll Taxes -- Labor: ____ % of line 1	
	3. Overtime Wages/Salaries - Labor (Attach University Representative's written authorization)	
	4. Fringe Benefits and Payroll Taxes -- Overtime: ____ % of line 3	
	5. Materials and Consumable items	
	6. Sales Taxes: ____ % of line 5	
	7. Rental Charges (attach U.S. Army Corps of Engineers' Schedule)	
	8. Royalties	
	9. Permits	
	10. Total Direct Expense -- sum of lines 1-9	
	11. Insurance and Bonds: ____ % of line 10 (up to 2% of line 10)	
TOTAL	12. Sum of lines 10 and 11	

 (Company Name)

 (Signature) ⁽²⁾

 (Title)

 (Date)

 (Company Name)

 (Signature) ⁽³⁾

 (Title)

 (Date)

- NOTES:
- (1) Round-off all Costs to the nearest dollar.
 - (2) This form shall be prepared and signed by Contractor or Subcontractor actually performing the Work activity indicated above.
 - (3) If this form is signed by a Subcontractor, it shall be reviewed and signed by Contractor certifying the accuracy of the information.

FIELD ORDER No.: 001

Project Name: Parcade Office Tenant Improvements
Project Number: 900165
To CM/Contractor:
Address:

DESCRIPTION OF CHANGE:

Date:
PCO #:

Please provide a Cost Proposal within 7 days of receipt of this Field Order.

In accordance with the General Conditions, Article 7, Paragraph 7.3.6; As a condition to General Contractor's right to an adjustment of the Contract Sum, pursuant to Article 7.3.5.3; General Contractor must keep detailed and accurate records itemizing each element of cost and shall provide substantiating records and documentation, including time cards and invoices. Such records and documentation shall be submitted to and approved University's Representative on a daily basis.

The PTC must follow all procedures set forth and submit per Article 4 of the General Conditions.

Estimated Adjustment
of Contract Sum: \$0

Estimated Adjustment
of Contract Time:

By: (Signature)
(Title)

Date:

Sara Mitchell
(University Representative)

(Signature)
Director of Construction Services
(Title)

Date:

NOTE: This Field Order will be superseded by a Change Order that will include the scope of the change in the Work and any actual adjustments of the Contract Sum and the Contract Time. Field Order shall only be used for Work currently under contract; and shall not be used to modify Option Sum or Option Time.

CHANGE ORDER

University of California Facility: Merced Campus

Change Order No. _____

Reference Field Order No. _____

PROJECT NAME:	LAZY K RESTORATION		
PROJECT LOCATION:	UNIVERSITY OF CALIFORNIA MERCED, MERCED CALIFORNIA		
PROJECT NO:	660175 1B 19900	CONTRACT DATE:	
TO CONTRACTOR:			
ADDRESS:			

DESCRIPTION OF CHANGE:

ADJUSTMENT OF CONTRACT SUM:

Original Contract Sum:	\$	_____
Prior Adjustments:	\$	_____
Contract Sum Prior to this Change:	\$	_____
Adjustment for this Change:	\$	_____
Revised Contract Sum:	\$	_____

ADJUSTMENT OF CONTRACT TIME:

Original Contract Time:	_____	(Days)
Prior Adjustments:	_____	(Days)
Contract Time Prior to this Change:	_____	(Days)
Adjustment for this Change:	_____	(Days)
Revised Contract Time:	_____	(Days)

Contractor waives any claim for further adjustments of the Contract Sum and the Contract Time related to the above described change in the Work.

RECOMMENDED:

By: _____
(Signature of University's Representative)

(Printed Name)

Date: _____

REVIEWED AND RECOMMENDED:

By: _____
(Signature of University's Designated Administrator)

(Printed Name)

Date: _____

FUNDS SUFFICIENT:

By: _____
(Signature from University's Accounting Office)

(Printed Name)

Date: _____

APPROVED:

UNIVERSITY: THE REGENTS OF THE
UNIVERSITY OF CALIFORNIA

(Printed or Typed Name)

By: _____
(Signature)

(Title)

Date: _____

ACCEPTED:

By: _____
(Contractor Signature)

(Printed Contractor Name)

Date: _____

**CONDITIONAL WAIVER AND RELEASE
ON PROGRESS PAYMENT**

Exhibit 10

NOTICE: THIS DOCUMENT WAIVES THE CLAIMANT'S LIEN, STOP PAYMENT NOTICE, AND PAYMENT BOND RIGHTS EFFECTIVE ON RECEIPT OF PAYMENT. A PERSON SHOULD NOT RELY ON THIS DOCUMENT UNLESS SATISFIED THAT THE CLAIMANT HAS RECEIVED PAYMENT.

Identifying Information:

Name of Claimant: _____

Name of Customer: _____

Job Location: _____

Owner: _____

Conditional Waiver and Release

This document waives and releases lien, stop payment notice, and payment bond rights the claimant has for labor and service provided, and equipment and material delivered, to the customer on this job through the Through Date of this document. Rights based upon labor or service provided, or equipment or material delivered, pursuant to a written change order that has been fully executed by the parties prior to the date that this document is signed by the claimant, are waived and released by this document, unless listed as an Exception below. This document is effective only on the claimant's receipt of payment from the financial institution on which the following check is drawn:

Maker of Check: _____

Amount of Check: \$ _____

Check Payable to: _____

Exceptions

This document does not affect any of the following:

- (1) Retentions.
- (2) Extras for which the claimant has not received payment.
- (3) The following progress payments for which the claimant has previously given a conditional waiver and release but has not received payment:

Date(s) of waiver and release: _____

Amount(s) of unpaid progress payment(s): \$ _____

- (4) Contract rights, including
 - (A) a right based on rescission, abandonment, or breach of contract, and
 - (B) the right to recover compensation for work not compensated by the payment.

Signature:

Claimant's Signature: _____

Claimant's Title: _____

Date of Signature: _____

**CONDITIONAL WAIVER AND RELEASE
UPON FINAL PAYMENT**

(CA Civil Code § 8136)

NOTICE: THIS DOCUMENT WAIVES THE CLAIMANT'S LIEN, STOP PAYMENT NOTICE, AND PAYMENT BOND RIGHTS EFFECTIVE ON RECEIPT OF PAYMENT. A PERSON SHOULD NOT RELY ON THIS DOCUMENT UNLESS SATISFIED THAT THE CLAIMANT HAS RECEIVED PAYMENT.

Identifying Information:

Name of Claimant: _____

Name of Customer: _____

Job Location: _____

Owner: _____

This document waives and releases lien, stop payment notice, and payment bond rights the claimant has for labor and service provided, and equipment and material delivered, to the customer on this job. Rights based upon labor or service provided, or equipment or material delivered, pursuant to a written change order that has been fully executed by the parties prior to the date that this document is signed by the claimant, are waived and released by this document, unless listed as an Exception below. This document is effective only on the claimant's receipt of payment from the financial institution on which the following check is drawn:

Maker of Check: _____

Amount of Check: \$ _____

Check Payable to: _____

Exceptions:

This document does not affect any of the following:

Disputed claims for extras in the amount of \$ _____.

Signature:

Claimant's Signature: _____

Claimant's Title: _____

Date of Signature: _____

UNCONDITIONAL WAIVER AND RELEASE UPON PROGRESS PAYMENT

(CA Civil Code § 8134)

NOTICE TO CLAIMANT: THIS DOCUMENT WAIVES AND RELEASES LIEN, STOP PAYMENT NOTICE, AND PAYMENT BOND RIGHTS UNCONDITIONALLY AND STATES THAT YOU HAVE BEEN PAID FOR GIVING UP THOSE RIGHTS. THIS DOCUMENT IS ENFORCEABLE AGAINST YOU IF YOU SIGN IT, EVEN IF YOU HAVE NOT BEEN PAID. IF YOU HAVE NOT BEEN PAID, USE A CONDITIONAL WAIVER AND RELEASE FORM.

Identifying Information:

Name of Claimant: _____

Name of Customer: _____

Job Location: _____

Owner: _____

Through Date: _____

This document waives and releases lien, stop payment notice, and payment bond rights the claimant has for labor and service provided, and equipment and material delivered, to the customer on this job through the Through Date of this document. Rights based upon labor or service provided, or equipment or material delivered, pursuant to a written change order that has been fully executed by the parties prior to the date that this document is signed by the claimant, are waived and released by this document, unless listed as an Exception below.

The claimant has received the following progress payment:

\$ _____

Exceptions:

This document does not affect any of the following:

- (1) Retentions.
- (2) Extras for which the claimant has not received payment.
- (3) Contract rights, including (A) a right based on rescission, abandonment, or breach of contract, and (B) the right to recover compensation for work not compensated by the payment.

Signature:

Claimant's Signature: _____

Claimant's Title: _____

Date of Signature: _____

**UNCONDITIONAL WAIVER AND RELEASE
UPON FINAL PAYMENT**

(CA Civil Code § 8138)

NOTICE TO CLAIMANT: THIS DOCUMENT WAIVES AND RELEASES LIEN, STOP PAYMENT NOTICE, AND PAYMENT BOND RIGHTS UNCONDITIONALLY AND STATES THAT YOU HAVE BEEN PAID FOR GIVING UP THOSE RIGHTS. THIS DOCUMENT IS ENFORCEABLE AGAINST YOU IF YOU SIGN IT, EVEN IF YOU HAVE NOT BEEN PAID. IF YOU HAVE NOT BEEN PAID, USE A CONDITIONAL WAIVER AND RELEASE FORM.

Identifying Information:

Name of Claimant: _____

Name of Customer: _____

Job Location: _____

Owner: _____

This document waives and releases lien, stop payment notice, and payment bond rights the claimant has for all labor and service provided, and equipment and material delivered, to the customer on this job. Rights based upon labor or service provided, or equipment or material delivered, pursuant to a written change order that has been fully executed by the parties prior to the date that this document is signed by the claimant, are waived and released by this document, unless listed as an Exception below. The claimant has been paid in full.

Exceptions:

This document does not affect any of the following:

Disputed claims for extras in the amount of \$ _____.

Signature:

Claimant's Signature: _____

Claimant's Title: _____

Date of Signature: _____

EXHIBIT 14
SELF-CERTIFICATION

For the Contractor and each Subcontractor indicated on the Report of Subcontractor Information, the following must be completed.

Indicate all Business category(ies) that apply by initialing next to the applicable category(ies):

 (Initial, if applicable) **Small Business Enterprise (SBE)** - an independently owned and operated concern certified, or certifiable, as small business by the Federal Small Business Administration (SBA). (Size standards by Standard Industrial Classification codes required by the Federal Acquisition Regulations, Section 19.102, may be found at www.sba.gov/size. The University may rely on written representation by the vendors regarding their status.) Annual average receipts, computed from the gross receipts for the last 3 fiscal years, do not exceed the amount listed in the MAXIMUM RECEIPTS TABLE below. The average annual receipt is computed by taking the sum of the gross receipts of the prior 3 fiscal years and dividing by 3.

MAXIMUM RECEIPTS TABLE	
Construction Services (by Contractor's License Classification):	AVERAGE ANNUAL RECEIPTS (Preceding 3 Years)
Class "A" - General Engineering	\$31,000,000
Class "B" - General Building	\$31,000,000
Class "C" - Specialty	\$13,000,000
Architectural & Engineering Services	\$4,500,000 (except landscape architectural services)
Landscape Architectural Services	\$6,500,000
Other services	For appropriate amount, see www.sba.gov/size

 (Initial, if applicable) **Disadvantaged Business Enterprise (DBE)** - a business concern which is at least 51% owned by one or more socially and economically disadvantaged individuals or, in the case of any publicly owned business, at least 51% of the stock of which is owned by such individuals and whose management and daily business operations are controlled by one or more of such individuals. Socially disadvantaged individuals are those who have been subjected to racial or ethnic prejudice or cultural bias because of their identity as members of a group without regard to their individual qualities. Economically disadvantaged individuals are those socially disadvantaged individuals whose ability to compete in the free private enterprise system has been impaired due to diminished capital and credit opportunities as compared to others in the same business area who are not socially disadvantaged. Business owners who certify that they are members of named groups (Black Americans, Hispanic Americans, Native Americans, Asian-Pacific Americans, Asian-Indian Americans) are to be considered socially and economically disadvantaged.

 (Initial, if applicable) **Women-Owned Business Enterprise (WBE)** - a business that is at least 51% owned by a woman or women who also control and operate it. "Control" in this context means exercising the power to make policy decisions. "Operate" in this context means being actively involved in the day-to-day management.

 (Initial, if applicable) **Disabled Veteran Business Enterprise (DVBE)** - a business that is at least 51% owned by one or more disabled veterans or, in the case of any publicly owned business, at least 51% of the stock of which is owned by such individuals and whose management and daily business operations are controlled by one or more of such individuals. A Disabled Veteran is a veteran of the military, naval, or air service of the United States with a service connected disability who is a resident of the State of California. To qualify as a veteran with a service connected disability, the person must be currently declared by the United States Veterans Administration to be 10% or more disabled as a result of service in the armed forces.

 (Initial, if applicable) **None of the above categories apply.**

I hereby certify under penalty of perjury under the laws of the State of California that I have read this certification and know the contents thereof, and that the business category indicated above reflects the true and correct status of the business in accordance with Federal Small Business Administration criteria and Federal Acquisition Regulations, FAR 19 pertaining to small, disadvantaged, women-owned, and disabled veteran business enterprises. I understand that falsely certifying the status of this business, obstructing, impeding or otherwise inhibiting any University of California official who is attempting to verify the information on this form may result in suspension from participation in University of California business contracts for a period up to five (5) years and the imposition of any civil penalties allowed by law.

INFORMATION FURNISHED BY:

(Print or Type Name of Owner and/or Principal)

(Name of Business or Firm)

a

(Insert type of business e.g. corporation, sole proprietorship, partnership, etc.)

By:

(Print Name)

(Title)

(Signature)

(Date)

PRIVACY NOTICE

The State of California Information Practices Act of 1977 (effective July 1, 1978) requires the University of California to provide the following information to individuals who are asked to supply personal information about themselves. Information furnished on the Self-Certification form may, in some cases, identify personal information of an individual.

- The University of California, Merced, is requesting the information contained in this form and the accompanying Report of Subcontractor Information.
- The Small Business Outreach Program Manager at the University of California, Merced, is responsible for maintaining the requested information. The contact information for the Small Business Outreach Program Manager may be found at: <http://www.ucop.edu/purchserv/documents/sbdrmgr.pdf>
- The maintenance of information is authorized in part by Public Contract Code section 10500.5.
- Furnishing the information requested on this form is mandatory. If SBE, DBE, WBE and/or DVBE status is applicable, furnishing such information is mandatory.
- Failure to provide the information may be a violation of bidding procedures and/or breach of the contract and the University may pursue any and all remedies permitted by the provisions of the Contract Documents.
- The information on this form is collected for monitoring and reporting purposes in accordance with state law and University policy.
- The individual may access information contained in this form and related forms by contacting the Small Business Outreach Program Manager(s).

**EXHIBIT 15
CERTIFICATE OF SUBSTANTIAL COMPLETION**

Project Name: LAZY K RESTORATION

Contractor: _____

Project Number: 660175 1B 19900

Date of Issuance: _____

The Work has been reviewed and the date of Substantial Completion is hereby established as of the date of issuance above.

A Certificate of Occupancy has been issued by the University's Building Official _____ on _____, _____.

A list of items to be completed or corrected is included herein. The failure to include any items on such list does not alter the responsibility of Contractor to complete all of the Work in accordance with the Contract Documents.

In accordance with the Contract Documents, Contractor is notified as follows:

1. Without limitation of Contractor's obligation to fully complete the Work within the Contract Time, Contractor shall complete or correct the Work on the list of items attached hereto within _____ days from the date of Substantial Completion.
2. Contractor shall be responsible for all Contract requirements except items or responsibilities of University set forth in Paragraph 2 above.
3. List of items to be completed or corrected: See Attached List

UNIVERSITY'S REPRESENTATIVE:

(Name of Firm)

(Signature)

(Typed or Printed Name)

(Title)

(Date)

UNIVERSITY: THE REGENTS OF THE UNIVERSITY OF CALIFORNIA

(Signature)

(Typed or Printed Name)

(Title)

(Date)

cc: Office of Risk Management

**EXHIBIT 16
GUARANTEE/WARRANTY FORM**

Date: _____
Project Name LAZY K RESTORATION
UNIVERSITY OF CALIFORNIA MERCED

Project Location _____
Project Number 660175 1B 19900

GUARANTEE FOR: _____
(Specification SECTION and Contract No.)
(the "Contract"), between the Regents of the University of California ("University") and

(Name of Contractor)
("Contractor") and

(Name of Subcontractor)
Hereby guarantee to University that the portion of the work described as follows:

Which it has provided for the above referenced Project, is of good quality; free from defects; free from any liens, claims, and security interests; and has been completed in accordance with Specifications SECTION _____ and the other requirements of the Contract.

The undersigned further agrees that, if at any time within _____ months after the date of the guarantee the undersigned receives notice from University that the aforesaid portion of the Work is unsatisfactory, faulty, deficient, incomplete, or not in conformance with the requirements of the Contract, the undersigned will, within 10 days after receipt of such notice, correct, repair, or replace such portion of the Work, together with any other parts of the Work and any other property which is damaged or destroyed as a result of such defective portion of the Work or the correction, repair, or replacement thereof; and that it shall diligently and continuously prosecute such correction, repair, or replacement to completion.

In the event the undersigned fails to commence such correction, repair, or replacement within 10 days after such notice, or to diligently and continuously prosecute the same to completion, the undersigned, collectively and separately, do hereby authorize University to undertake such correction, repair, or replacement at the expense of the undersigned; and Contractor will pay to University promptly upon demand all costs and expenses incurred by University in connection therewith.

SUBCONTRACTOR

Signed: _____
Title: _____
Typed Name: _____
Name of Firm: _____
Contractor License Classification, Code, and Number: _____
Address: _____

CONTRACTOR

Signed: _____
Title: _____
Typed Name: _____
Name of Firm _____

LAZY K RESTORATION
**Project No.: 661075 1B
19900**
University of California,
Merced

Request for Information			
RFI Number:	_____		
Date Created:	___/___/___	___/___/___	___/___/___
Answer Required by:	___/___/___	___/___/___	___/___/___
Priority:	<input type="checkbox"/> Urgent	<input type="checkbox"/> High	<input type="checkbox"/> Low
	<input type="checkbox"/> Normal	<input type="checkbox"/> Low	

Submitted By

Company: _____ Subject: _____
Contact: _____ Discipline: _____
Telephone: _____ Category: _____
Email: _____ Reason: _____

Question

Suggestion

Answer

Received
By: _____ Date: ___/___/___

EXHIBIT 18

UTILITY SERVICE INTERRUPTION/SHUT DOWN REQUEST

A minimum of 7 working days advance notice
is required prior to each utility service interruption/shut down
(Refer to Section 01 35 00 Special Requirements)

SUBMIT DIFFERENT FORM FOR EACH UTILITY

To University's Representative: _____

Submitted by Contractor: _____

(Printed Name/Title) _____

Project No: 900165 _____

Project Name: PARCADE OFFICE TENANT IMPROVEMENTS _____

Date Request Submitted: _____

Shut Down Date Requested: _____

Commencing Time of Shut Down: _____ A.M. _____ P.M.

Duration of Shutdown: _____ A.M. _____ P.M.

Type of Utility Service to be shut down:

Contractor Signature: _____

The above shut down HAS / HAS NOT been scheduled as requested.

EXHIBIT 18
UTILITY SERVICE INTERRUPTION/SHUT DOWN REQUEST

Additional comments if required:

Confirmed by telephone with _____
Confirmed via fax on _____ by _____

DOES NOT APPLY

EXHIBIT 19
 UNIVERSITY OF CALIFORNIA, MERCED CAMPUS
 NEW CONSTRUCTION PROJECT INFORMATION FORM
 TO COMPLY WITH THE TERMS OF THE
 GENERAL PERMIT TO DISCHARGE STORM WATER
 ASSOCIATED WITH CONSTRUCTION ACTIVITY (WQ ORDER No. 2009-0009-DWQ)

I. NOTICE OF INTENT

UNIVERSITY OF CALIFORNIA, MERCED CAMPUS	WDID#	5F24S319219
--	--------------	--------------------

II. PROPERTY OWNER

Name	Contact Person		
Mailing Address	Title		
City MERCED	State CA	Zip 95343	Phone (209) 228-4404

III. CONTRACTOR INFORMATION

Contractor	Contact Person		
Mailing Address	Title		
City	State	Zip	Phone () -

IV. NEW CONSTRUCTION PROJECT INFORMATION

Project No			
Project Name	University's Representative		
Physical Address/Location	Latitude	Longitude	County
City (or nearest City) Merced	Zip	Site Phone Number () -	Emergency Phone Number () -
A. Total size of construction site area: ___ Acres	B. Total area to be disturbed: ___ Acres (% of total ___)		
C. Percent of site imperviousness (including rooftops): Before Construction: ___% After Construction: ___%			
D. Tract Number(s): ___	E. Mile Post Marker:		
F. Is the construction site part of a larger common plan of development or sale? <input checked="" type="checkbox"/> YES <input type="checkbox"/> NO	G. Name of plan or development:	H. Construction commencement date: ___/___/___	
I. Percentage of site to be mass graded:	J. Projected construction dates: Complete grading: ___/___/___ Complete project: ___/___/___		
K. Type of Construction (Check all that apply):			
1. <input type="checkbox"/> Residential 2. <input type="checkbox"/> Commercial 3. <input type="checkbox"/> Industrial 4. <input type="checkbox"/> Reconstruction 5. <input type="checkbox"/> Transportation 6. <input type="checkbox"/> Utility Description: 7. <input type="checkbox"/> Other (Please List):			

V. IMPLEMENTATION OF NPDES PERMIT REQUIREMENTS

A. STORM WATER POLLUTION PREVENTION PLAN (SWPPP) (check one)

A SWPPP has been prepared for this facility and is available for review:
Date Prepared: ___/___/___ Date Amended: ___/___/___

A SWPPP will be prepared and ready for review by (enter date): ___/___/___

A tentative schedule has been included in the SWPPP for activities such as grading, street construction, home construction, etc.

B. MONITORING PROGRAM

A monitoring and maintenance schedule has been developed that includes inspection of the construction BMPs before Anticipated storm events and after actual storm events and is available for review.

If checked above: A qualified person has been assigned responsibility for pre-storm and post-storm BMP inspections to identify effectiveness and necessary repairs or design changes. YES NO

Name: _____ Phone: () - _____

C. PERMIT COMPLIANCE RESPONSIBILITY

A qualified person has been assigned responsibility to ensure full compliance with the Permit, and to implement all elements of the Storm Water Pollution Prevention Plan including:

1. Preparing an annual compliance evaluation. YES NO
Name: _____ Phone: () - _____

2. Eliminating all unauthorized discharges. YES NO

VI. VICINITY MAP AND FEE (must show site location in relation to nearest named streets, intersections, etc.)

Have you included a vicinity map with this submittal? YES NO

UC Merced pays annual fee; no fee required by Contractor

VII. CONTRACTOR CERTIFICATION

"I certify under penalty of law that this document and all attachments were prepared under my direction and supervision in accordance with a system designed to assure that qualified personnel properly gather and evaluate the information submitted. Based on my inquiry of the person or persons who manage the system, or those persons directly responsible for gathering the information, the information submitted is, to the best of my knowledge and belief, true, accurate, and complete. I am aware that there are significant penalties for submitting false information, including the possibility of fine or imprisonment. In addition, I certify that the provisions of the permit, including the development and implementation of a Storm Water Pollution Prevention Plan and a Monitoring Program Plan will be complied with."

Printed Name: _____

Signature: _____ Date: _____

Title: _____

THE NEXT SECTION TO BE COMPLETED BY UNIVERSITY'S REPRESENTATIVE

VIII. UNIVERSITY CERTIFICATION

"I certify under penalty of law that this document and all attachments were prepared under my direction and supervision in accordance with a system designed to assure that qualified personnel properly gather and evaluate the information submitted. Based on my inquiry of the person or persons who manage the system, or those persons directly responsible for gathering the information, the information submitted is, to the best of my knowledge and belief, true, accurate, and complete. I am aware that there are significant penalties for submitting false information, including the possibility of fine or imprisonment. In addition, I certify that the provisions of the permit, including the development and implementation of a Storm Water Pollution Prevention Plan and a Monitoring Program Plan will be complied with."

Printed Name: _____

Signature: _____ Date: _____

Title: _____

**EXHIBIT 22
 MATERIAL SUBSTITUTION PROPOSAL**

TO (NAME): _____
 PROJECT: **LAZY K RESTORATION** PROJECT No.: **660175**
 _____ **1B 19900**

A. We hereby submit for your consideration the following product instead of the specified item:

1. Section: _____
2. Article Number: _____
3. Specified Item: _____
4. Proposed Substitution (Mfg., Type, Model, etc.): _____

B. Complete all of the following:

1. Does this substitution offer University a cost credit (including costs for changes by other subcontractors)?
 Yes No How much? \$ _____

List of Subcontractors, if any that may be affected by the substitution.	
Name	Trade

2. Does this substitution offer earlier delivery or less Contract Time?
 Yes No
 How much and why? _____
3. How does this substitution affect any dimensions, layout, or details of other subcontractors as shown on the Drawings?

4. What are the specific differences between this substitution and the specified item?

C. Attach the following as applicable (Check if attached):

1. Manufacturer's technical data
2. Laboratory test or performance results
3. Drawings & wiring diagrams of the proposed product
4. Drawings & description of changes required by other subcontractors
5. Samples
6. Manufacturer's guarantee & maintenance instructions

D. Submitted by Contractor: _____

Statement by Contractor that the proposed substitution is in full compliance with the requirements of the Contract Documents and Applicable Code Requirements.

Signature: _____ Date: _____

E. University Review Decision:

For Use Only by University's Representative			
Accepted	Rejected	Revise and Resubmit	See Attached

University's
Representative
Signature: _____ Date: _____

Exhibit 23 - Submittal Approval Page

By Submittal Item

Preparer Approval	University Approval
<p>Spec Section Sub Section Item No. Rev</p> <p>Description: _____</p> <p>By: _____</p> <p>Date: _____</p>	
University of California, Merced Approval	Design Team Approval
<ul style="list-style-type: none"> <input type="checkbox"/> Approved <input type="checkbox"/> Approved as Noted <input type="checkbox"/> Revise & Resubmit <input type="checkbox"/> Rejected <p>Review is general and only for conformance with the design concept of the project and with the information given in the contract documents, and shall not be construed as relieving the Contractor of responsibility for omissions or errors, including performance, details, dimensions, materials, configuration, etc. Review of a separate item does not indicate acceptance of an assembly which the item functions.</p> <p>By: _____</p> <p>Date: _____</p>	



Letter of Instruction

Detailed, Grouped by Each Number

Lazy K Restoration
5200 N Lake Rd
Merced CA 95343

Project # 660175 1b 19900
Tel: 209 228-4479 Fax: 209 228-4468

University of California, Merced

Number: 001

Date: 5/9/2012

To:	From: University of California, Merced Sara Mitchel 5200 North Lake Road Merced, CA 95343
------------	---

Subject	Type	Reason
Lazy K Restoration		

Location	Reference	Not To Exceed Cost
		0

Description

The following information is hereby issued as a clarification or interpretation of the Contract Documents. This is a clarification or interpretation only and not intended to change the scope of the Work, the Contract Sum, or the Contract Time.

EXHIBIT 27

GENERAL CONTRACTOR CLAIM CERTIFICATION

Pursuant to Article 4.3.3 of the General Conditions, I certify as follows:

1. The Claim to which this certification is attached is made in good faith.
2. Amounts claimed for costs, expenses and damages incurred by General Contractor are accurate and complete. Supporting data for amounts incurred by General Contractor is accurate and complete. Any such supporting data, including any such new amounts, submitted after the execution of this certification, will be accurate and complete.
3. To the best of my knowledge and belief, amounts claimed, and supporting data submitted by General Contractor on behalf of any and all subcontractors or suppliers, of all tiers, or any person or entity under General Contractor, are accurate and complete. General Contractor will not submit, after the date of execution of this certification, any such supporting data, including any such new amounts that, to the best of my knowledge and belief, is not accurate and complete.
4. The amount requested accurately reflects the adjustment of the Contract Sum for which the General Contractor believes the University is liable.
5. Attached hereto is a certification that has been executed by each Subcontractor claiming not less than 5% of the total monetary amount sought by the claim to which this certification is attached.
6. I am duly authorized to certify the Claim on behalf of the General Contractor.

I declare under penalty of perjury under the laws of the State of California that the foregoing is true and correct and that this declaration was executed at: _____(Name of City if within a City, otherwise Name of County), in the State of _____(State), on _____(Date).

(Signature)

(Print Name)

(Name of General Contractor)

EXHIBIT 28

SUBCONTRACTOR CLAIM CERTIFICATION

Pursuant to Article 4.3.3 of the General Conditions, I certify as follows:

1. The portion of the Claim made on behalf of the Subcontractor to which this certification is attached is made in good faith.
2. Amounts claimed for costs, expenses and damages incurred by the Subcontractor are accurate and complete. Supporting data for amounts incurred by the Subcontractor is accurate and complete. Any such supporting data, including any such new amounts, submitted to Contractor after the execution of this certification, will be accurate and complete.
3. To the best of my knowledge and belief, amounts claimed, and supporting data submitted to Contractor by the Subcontractor on behalf of any and all subcontractors or suppliers to Subcontractor, of all tiers, or any person or entity under Subcontractor, are accurate and complete. Subcontractor will not submit, after the date of execution of this certification, any such supporting data, including any such new amounts that, to the best of my knowledge and belief, is not accurate and complete.
4. The amount requested accurately reflects the amount for which the Subcontractor believes the University is liable to Contractor.
5. I am duly authorized to certify the Claim on behalf of the Subcontractor.

I declare under penalty of perjury under the laws of the State of California that the foregoing is true and correct and that this declaration was executed at: _____ (Name of City if within a City, otherwise Name of County), in the State of _____ (State), on _____ (Date).

(Signature)

(Print Name)

(Name of Subcontractor)

CONTRACTOR / SUBCONTRACTOR DAILY REPORT

Contractor
/Subcontractor: _____

Daily Details

Date: ___ ___ / ___ ___ / ___ ___

Temperature: A.M. °F P.M. °F

Weather: _____

Manpower *(List Quantity)*

Project Managers: _____ Other: _____

Superintendents: _____ Other: _____

Non-Working

Foremen: _____ Other: _____

Working Foremen: _____ Other: _____

Journeyman: _____ Other: _____

Apprentices: _____ Other: _____

Laborers: _____ Other: _____

Subcontractors on Site: _____

Work Performed in Each
Area:

**Equipment
Rented/Used:**

**Shortages/Discrepancies
of Delivered Materials:**

Delays/Problems:

**Unsafe or Hazardous
Conditions:**

Questions:

Last Safety Meeting

Date: ___ ___ / ___ ___ / ___ ___

Topic: _____

Number of Additional Sheets Attached: _____

Signed: _____

LAZY K RESTORATION
UNIVERSITY OF CALIFORNIA MERCED
MERCED, CALIFORNIA

PROJECT NO.: 660175 1B 19900

Printed Name:

Title:

HOT WORK PERMIT

**BEFORE INITIATING HOT WORK, ENSURE PRECAUTIONS ARE IN PLACE!
MAKE SURE AN APPROPRIATE FIRE EXTINGUISHER IS READILY AVAILABLE!**

This Hot Work Permit is required for any operation involving open flames or producing heat and/or sparks. This includes, but is not limited to: Brazing, Cutting, Grinding, Soldering, Thawing Pipe, Torch-Applied Roofing, and Cadwelding

INSTRUCTIONS

1. Verification below is to be completed by a qualified person.
2. The completed original is to be presented to the inspector prior to commencing work.
3. Must also be submitted to C.M. 24 hours before work is started to insure proper notifications are made.

HOT WORK BEING DONE BY:

UCM Employee

Contractor: _____

Date: _____ W.O.# _____

Start Time: _____

Location / Building / Floor _____

Nature of Job / Object _____

Name of Person Doing Hot Work _____

I verify the above location has been examined, the precautions checked on the Required Precautions Checklist have been taken to prevent fire, and permission is authorized for work.

Signed: _____

Permit Expires	Date	Time	
			AM PM

Fire Detection Disabled Reactivated

Date / Time _____ _____

Initial: _____ _____

**THIS PERMIT IS GOOD FOR
ONE DAY ONLY**

Ref: -

Inspection No. -

REQUIRED PRECAUTIONS CHECKLIST

- Automatic Fire Detection Disabled?
- Available sprinklers, hose streams, and extinguishers are in service/operable?
- Hot work equipment is in good repair?

Requirements within 10 m (35 feet) or work:

- Flammable liquids, dust, lint, and oil deposits removed?
- Explosive atmosphere in area eliminated?
- Floors swept clean?
- Combustible floors wet down, covered with damp sand or fire-resistant sheets?
- Remove other combustibles where possible. Otherwise protect with fire-resistant tarpaulins of metal sheets?
- All wall and floor openings covered?
- Fire-resistant tarpaulins suspended beneath work?

Work on walls or ceiling / enclosed equipment:

- Construction is non-combustible and without combustible covering or insulation?
- Combustibles on other side of walls moved away?
- Danger exists by condition of heat into another area?
- Enclosed equipment cleaned of all combustibles?
- Containers purged of flammable liquids/vapors?

Fire Watch / Hot Work area monitoring:

- Fire watch will be provided during and for 30 minutes after work, including any coffee or lunch breaks?
- Fire watch is supplied with suitable extinguishers?
- Fire watch is trained in use of this equipment? And is sounding alarm?
- Fire watch may be required for adjoining areas, above and below?
- Monitor hot work area 30 minutes after job is completed.

Other precautions taken:

- Confined space entry permit required?
- Area protected with smoke or heat detection?
- Ample ventilation to remove smoke/vapor from work area?
- Lockout / tagout required?

LAZY K RESTORATION
University of California Merced
Project No. 900165

EXHIBIT 30 – WELDING/HOT WORK PERMIT

**Requests for
Inspections and/or Tests**

Initial Inspection No.: _____ (CM)

Lazy K Restoration

Project No.: 661075 1b 19900
Tel: _____

University of California – Merced
Fax: _____

Date of Request: _____ Person Accompanying
Inspector: _____

Date of Inspection: _____ Cell Phone: _____

Installing Company: _____ Requested
Time: _____ Reference # _____

Description System / Discipline

Location – Items to Be Inspected

Quality Control

Verified by: _____ on _____ (date).

IOR's Observations

Items Passed

Items Failed

Signature _____

Signed Date _____



SF BAY AREA OFFICE
1720 Solano Avenue
Berkeley, CA 94707
Phone: 510/559-9603
Fax: 510/559-9605
www.vollmarconsulting.com

FINAL VERNAL POOL RESTORATION DESIGN AND CONSTRUCTION PLAN

**Lazy K Ranch Permittee-Responsible Mitigation Preserve,
Madera County, California**

UCM Project

Prepared for:

Phil Woods, AIA, AICP
Director of Physical & Environmental Planning
University of California, Merced
5200 North Lake Road
Merced, CA 95343

Prepared by:

Vollmar Natural Lands Consulting, Inc.
1720 Solano Avenue
Berkeley, CA 94707
Contact: John Vollmar
510-559-9603

May 8, 2015

TABLE OF CONTENTS

1 INTRODUCTION	2
2 BACKGROUND INFORMATION	2
3 RESTORATION DESIGN APPROACH	7
4 CONSTRUCTION PROCESS	18
5 CUT-FILL CALCULATION	21
6 PROJECT PERMITS	21
7 EQUIPMENT STAGING AND WATER	21
8 ENVIRONMENTAL AWARENESS TRAINING	21
9 BEST MANAGEMENT PRACTICES	22

Figures

Figure 1. Regional Vicinity Map	3
Figure 2. Site Map	4
Figure 3. Final Vernal Pool Restoration Design	6
Figure 4. Vernal Pool Restoration and Design Reference Area Soil Pit Locations	8
Figure 5. Vernal Pool Restoration and Design Area Elevation and Hydrology	10
Figure 6. Vernal Pool Restoration Area Cut/Fill Calculation	11
Figure 7-A. Vernal Pool Design Reference Area Topographic Map	13
Figure 7-B. Vernal Pool Restoration Area (West) Topographic Map	14
Figure 7-C. Vernal Pool Restoration Area (East) Topographic Map	15
Figure 8-A. Comparison of Pool Size Distributions (Count of Pools)	16
Figure 8-B. Comparison of Pool Size Distributions (Sum of Pool Area)	16
Figure 9. Comparison of Maximum Pool Depth Distributions	17

1 INTRODUCTION

The University of California, Merced (UCM) is establishing a 65.5-acre permittee-responsible mitigation preserve (preserve) on the Lazy K Ranch (ranch) located in Madera and Merced counties, California (**Figures 1 and 2**). The preserve is being established to provide mitigation for project impacts from development of UCM Campus and the University Community North Project (UCM Project). The preserve consists of a 65.5-acre wetland restoration area (**Figure 2**). This area historically supported mound-basin topography and associated vernal pools and swales but was leveled for agriculture prior to the 1950s. The proposed wetland restoration will restore a semblance of the historic mound-basin topography and 10.5 acres of vernal pool wetlands. The restoration design is based on a nearby “design reference area” on the ranch with intact mound-basin topography and associated vernal pools (**Figure 2**).

This document presents the restoration design and specifications as well as the construction practices to be employed on the wetland restoration area. The design is based on extensive analyses of the soils, topography, and surface hydrology within both the restoration and design reference area. It was also developed in reference to a set of 18 natural “reference pools” within the design reference area that were selected by the U.S. Army Corps of Engineers (Corps). The hydrologic and floristic characteristics of the reference pools will be used to evaluate the performance of the restored pools. Consequently, the restored pools were designed to have a general distribution of sizes and depths similar to that of the reference pools.

The proposed design involves re-contouring of the entire surface of the restoration area to restore mound and basin (pool) features, as well as interconnecting swales. This approach is different from other vernal pool restoration projects that have been conducted on previously leveled ground. These previous projects typically involved localized excavation of basins within the leveled terrain, sometimes with limited mound reconstruction in the immediate vicinity of the basins using the excavated soils. To our knowledge, the more comprehensive, site-wide approach being utilized on this site has not been conducted before. This construction approach will be implemented using a specific step-by-step approach as described in this document. The intended outcome is a genuine, landscape-level restoration of vernal pool habitats and associated upland mounds across the restoration area.

2 BACKGROUND INFORMATION

The proposed wetland restoration area currently consists of a dry pasture used for livestock grazing (**Figure 2**). This pasture was leveled prior to the 1950s for flood irrigation but has been subsequently managed and maintained as dry pasture. Soil pit analyses showed that the site has been only shallowly ripped (to about 18 inches), leaving the subsurface hardpan largely intact. Intact, native mound-basin topography is present just east of the site in areas of the ranch that were not leveled. The primary purpose of the project is to grade and re-contour the restoration area to restore a semblance of the original mound-basin topography and associated vernal pools and swales. While the specific original topography cannot be re-established, due to a lack of available aerial photography or other records prior to leveling, the proposed design was developed in reference to the adjacent design reference area with intact mound-basin topography. Thus, the proposed restoration design represents a landscape that reflects the historic landscape.

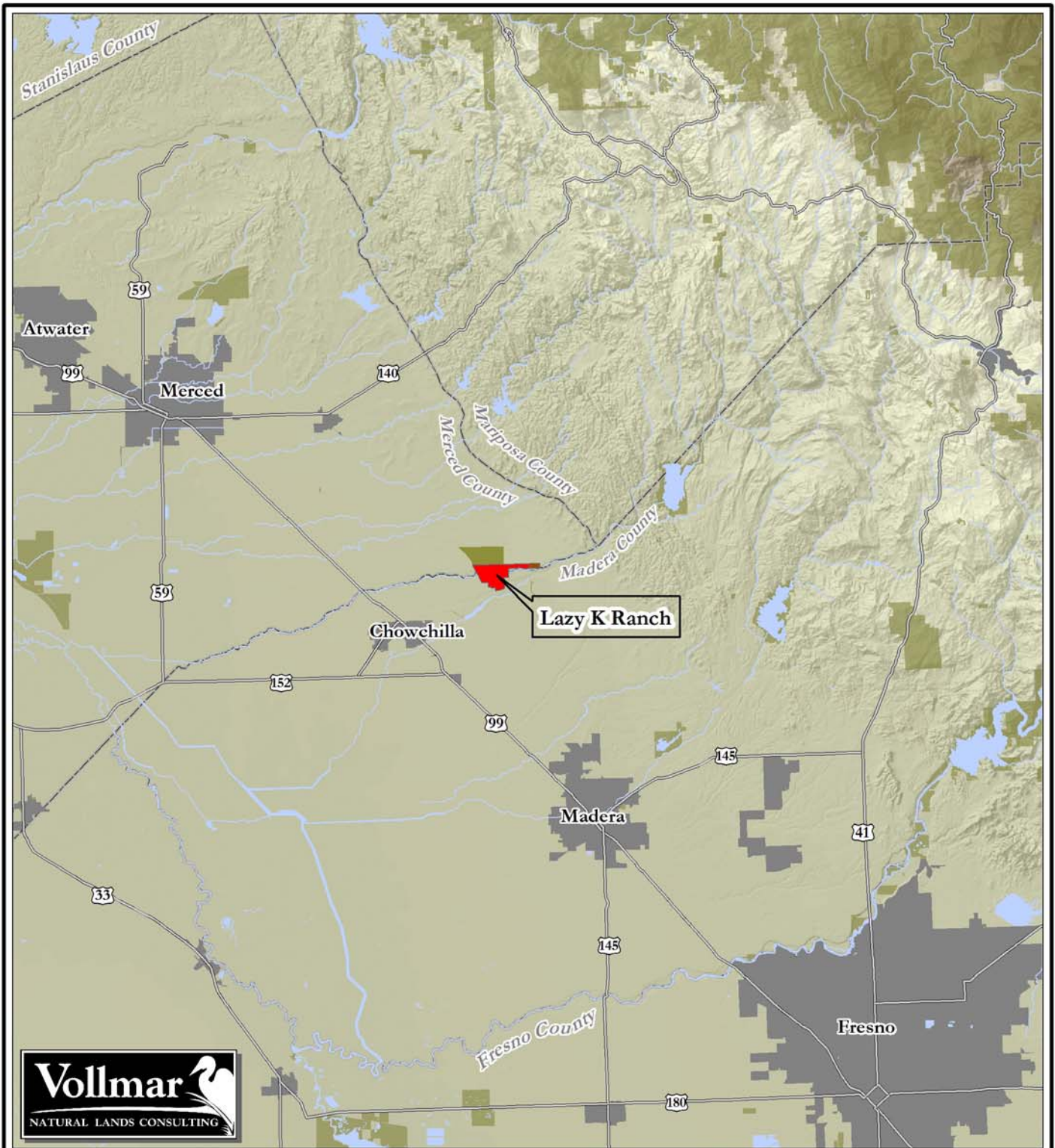

Legend

- Lazy K Ranch
- Public and/or Preserved Land
- Urbanized Area
- Water Body
- River or Major Creek
- Highway

Data Sources: VNLC, 2015 | TIGER, 2000 | CPAD, 2012
 USGS, Various | GAP, 1998 | DWR, 2001
 GIS/Cartography by: C. De La Torre, Feb. 2015
 Map File: Vicinity_UCM-LTMP_A-P_2015-0203.mxd

FIGURE 2
Regional Vicinity Map
Lazy K Ranch

Merced and Madera County, California



1:506,880
 (1 inch = 8 miles, at letter layout)

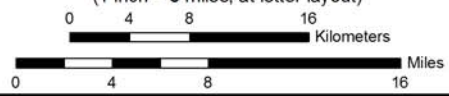
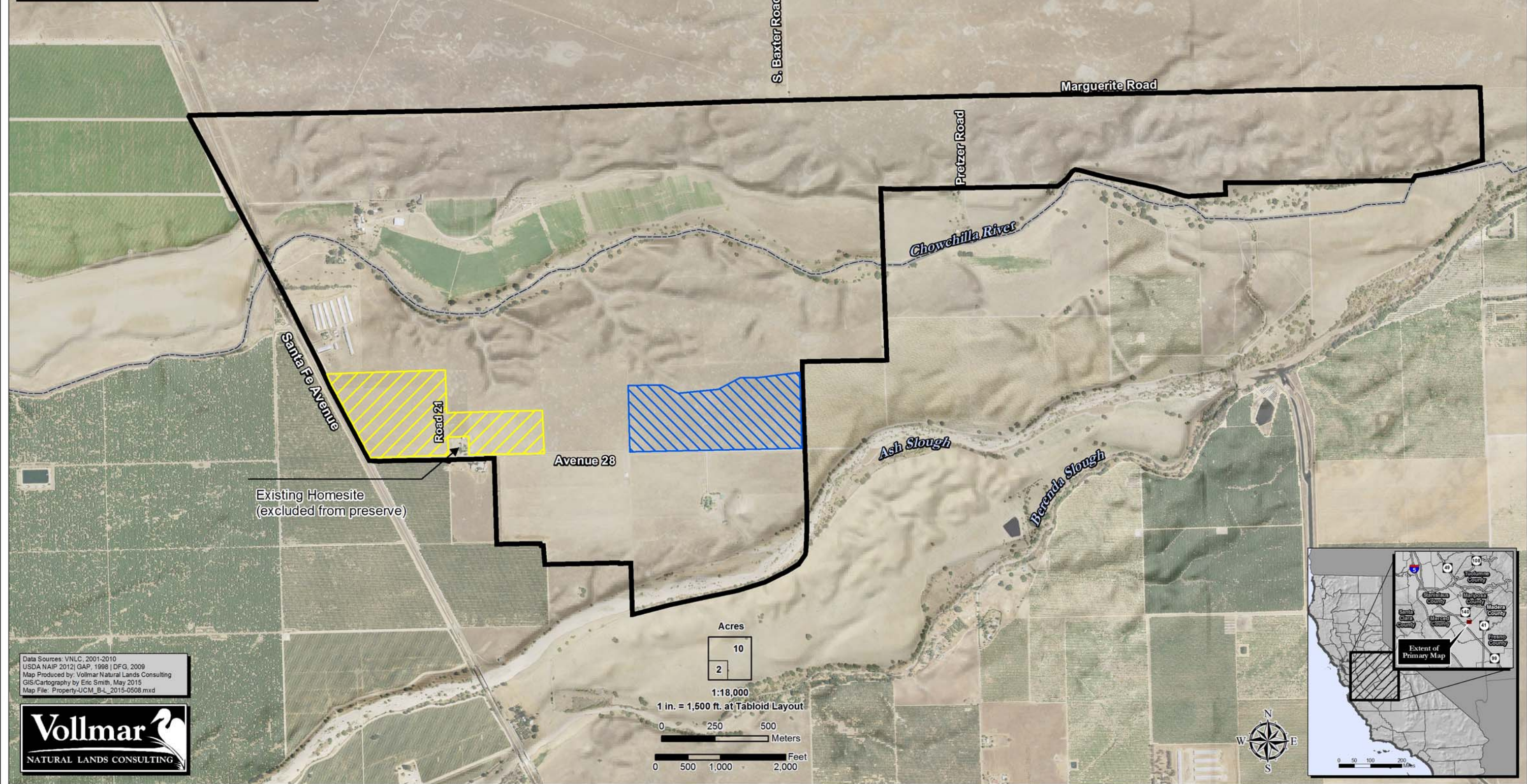

FIGURE 2: Site Map
UCM Lazy K Ranch Mitigation Preserve
Madera County, California

Legend

-  UCM Wetland Restoration Area (65.5 ac.)
-  Design Reference Area (63.5 acres)
-  Lazy K Ranch Boundary (1,556 acres)
-  County Boundary



Data Sources: VNLC, 2001-2010
 USDA NAIP 2012 | GAP, 1998 | DFG, 2009
 Map Produced by: Vollmar Natural Lands Consulting
 GIS Cartography by: Eric Smith, May 2015
 Map File: Property-UCM_B-L_2015-0508.mxd



Acres

10
2

1:18,000
 1 in. = 1,500 ft. at Tabloid Layout

0 250 500 Meters

0 500 1,000 2,000 Feet



Overview of Vernal Pool Structure and Function

Vernal pools are a type of naturally-occurring seasonal wetland in the region. They form within natural basins across the landscape due to the presence of an underlying soil ‘hardpan’ (or other limited-permeability soil layer) that restricts downward percolation of water and thus causes the development of a “perched” water table during the rainy season. The hardpan layer on the Madera soils that occur throughout the restoration area is typically 2-3 feet below the surface and typically varies from 1-4 feet thick. Vernal pools would not form without the presence of the hardpan and the perched water table it creates, and thus the hardpan is a critical feature to understand as a key component of vernal pool function. Vernal pools are filled by natural rainfall and run-off. Pools typically begin filling in late fall or early winter with the first heavy rains, remain continuously or intermittently ponded through winter, and typically dry in early to late spring depending on seasonal rainfall and pool depth. Once dry, they remain dry and desiccated throughout the summer and fall until the onset of the next rainy season. Vernal pools typically occur in hydrologically interconnected complexes with water flowing between pools during and following heavy rains along vernal swales.

Vernal pools support a unique suite of native plant and aquatic wildlife species that have evolved within this habitat. These species are specifically adapted to withstand the combination of winter/spring inundation and summer/fall desiccation. These native species include many rare or endangered species endemic to California vernal pools. The high diversity of unique native and rare species within vernal pools is the main reason there is so much interest in their conservation and restoration.

Vernal pools and swales exist within a surrounding upland environment of meandering low ridges and individual mounds. On a landscape level, the pools and swales along with the low ridges and mounds co-exist as fully integrated components. In the intact, unlevelled habitat to the east of the restoration area (**Figure 3**), the uplands consist of a series of somewhat parallel, meandering low ridges generally trending east-west. Between these low ridges are ‘macro-swales’ that also trend east-west across the landscape in a sinuous manner. We have found that the upland ridges and mounds constitute roughly 60% of the landscape while the macro-swales constitute roughly 40% of the landscape. The vernal pools and swales tend to be concentrated within the macro-swales (roughly 80% of the total wetland acreage) and the pools in these areas tend to be elongated and sinuous, following the direction of the macro-swales. There are also some vernal pools situated within the upland mounds. These typically exist as more isolated features that are generally more oval in shape.

Effects of Land Leveling

The land leveling that occurred on the restoration area prior to the 1950s eliminated the natural mound-basin topography. The area currently has leveled terrain that drops very gently from east to west with low remnant soil berms for flood irrigation.

The land leveling involved down-cutting some areas and building up other areas within the site. This changed the depth relationship between the soil surface and the underlying hardpan. In some areas, the grading exposed or even removed the hardpan; in other areas, soils were built up, causing the hardpan to be deeper than under natural conditions. We have analyzed the current soil-hardpan conditions including excavation of numerous backhoe pits across the ranch that cut through the hardpan, and more than 140

Figure 3 Final Vernal Pool Restoration Design

UCM Lazy K Ranch Mitigation Preserve
Madera County, California

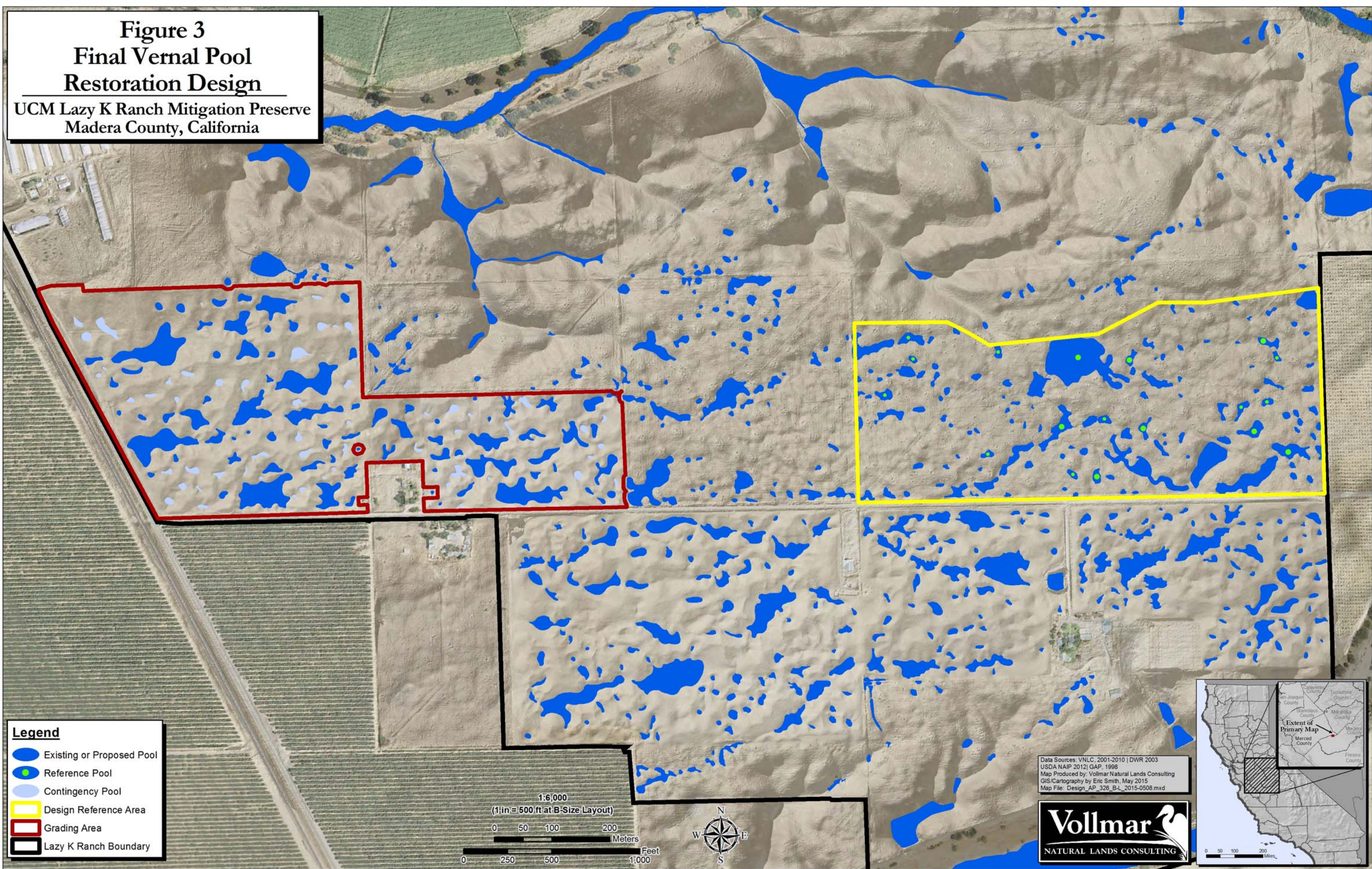

Legend

- Existing or Proposed Pool
- Reference Pool
- Contingency Pool
- Design Reference Area
- Grading Area
- Lazy K Ranch Boundary

1:6,000
(1 in = 500 ft at B-Size Layout)

0 50 100 200 Meters

0 250 500 1,000 Feet

Data Sources: VNLC, 2001-2010 | DWR 2003
USDA NAIP 2012 | GAP, 1998
Map Produced by: Vollmar Natural Lands Consulting
GIS/Cartography by Eric Smith, May 2015
Map File: Design_AP_326_B-L_2015-0508.mxd



Extent of Primary Map

0 50 100 200 Miles

shallower pits within the restoration area down to the surface of the hardpan. Data from these soil pits were used to develop the final restoration design related to proposed locations and depths of soil excavation and contouring.

3 RESTORATION DESIGN APPROACH

Figure 3 shows the final wetland restoration design. It also shows the distribution of pools within the adjacent design reference site as well as the selected reference pools. This figure also includes the proposed restoration of another area within the Lazy K Ranch, which will be restored as part of an unrelated project. This design is included for landscape context.

The design was developed through a comprehensive analysis of soils, topography, and surface hydrology within the design reference and restoration areas, the identification and analysis of ‘macro-swale’ versus ‘low ridge’ landscape features within the design reference area, and hand drawing of restoration contours to closely mimic slopes and grades within the design reference area. The design was also developed in reference to the set of 18 reference pools selected by the Corps that will be used to gauge the performance success of the restored pools (**Figure 3**). The influence of these parameters on the design approach and outcome are discussed below.

Soil Pit Analysis

We excavated a total of 157 soil pits within the restoration and adjacent natural areas (**Figure 4**). These were primarily shallow pits excavated down to the hardpan surface but also included a limited number of deeper pits excavated through the hardpan to investigate its thickness, strength, and composition. The surface soil, clay layer, hardpan depth, and other soil characteristics within each pit were recorded and categorized as presented in **Figure 4**.

The average depth to hardpan in the restoration and design reference areas are comparable, at approximately 20 inches below the surface. In the restoration area, though, the range of values is much greater, with the hardpan very near the surface in some locations and very deep in others, reflecting the historic disturbance of land leveling. In the extreme form of this condition, the hardpan is actually exposed on the surface, though this is only possible in a limited area which was never subjected to any ripping.

In areas which were ripped, in pits with the hardpan less than 18 inches from the surface (about 20% of pits in the restoration area), we found that historic ripping had disrupted the surface of the hardpan, down to a depth of about 18 inches. Since the hardpan was typically 1-4 feet thick, and began some distance below the surface, some hardpan remained undisturbed below the depth of the ripping in nearly all pits. Nonetheless, we classified pits with damaged hardpan surface as low-priority restoration areas.

In about 10% of pits in the restoration area, an intact hardpan was not detected, either too deep to detect, ripped all the way through, or carried away completely when the leveling equipment cut deeply into a former mound. We classified such locations as unsuitable for restoration.

The soil texture is largely sandy loam, however in many pits we observed an approximately 5-inch thick layer of sandy clay loam that has accumulated immediately above the hardpan. This “clay” layer was present in about 80% of pits in the reference area. The process of leveling and ripping apparently

Figure 4 Vernal Pool Restoration and Design Reference Area Soil Pit Locations

UCM Lazy K Ranch Mitigation Preserve
Madera County, California

Legend		Key to Soil Pit Points	
	Existing or Proposed Pool	Aquitard Suitability Shape of Point: ● Highest ◐ High ◑ Medium ◒ Low ✕ No Aquitard ◊ Exposed Duripan	Depth to Aquitard (in.) Color of Point: 1-7 8-10 11-13 14-16 17-19 20-22 23-26 27-30 31-60
	Contingency Pool		
	Design Reference Area		
	Grading Area		
	Lazy K Ranch Boundary		

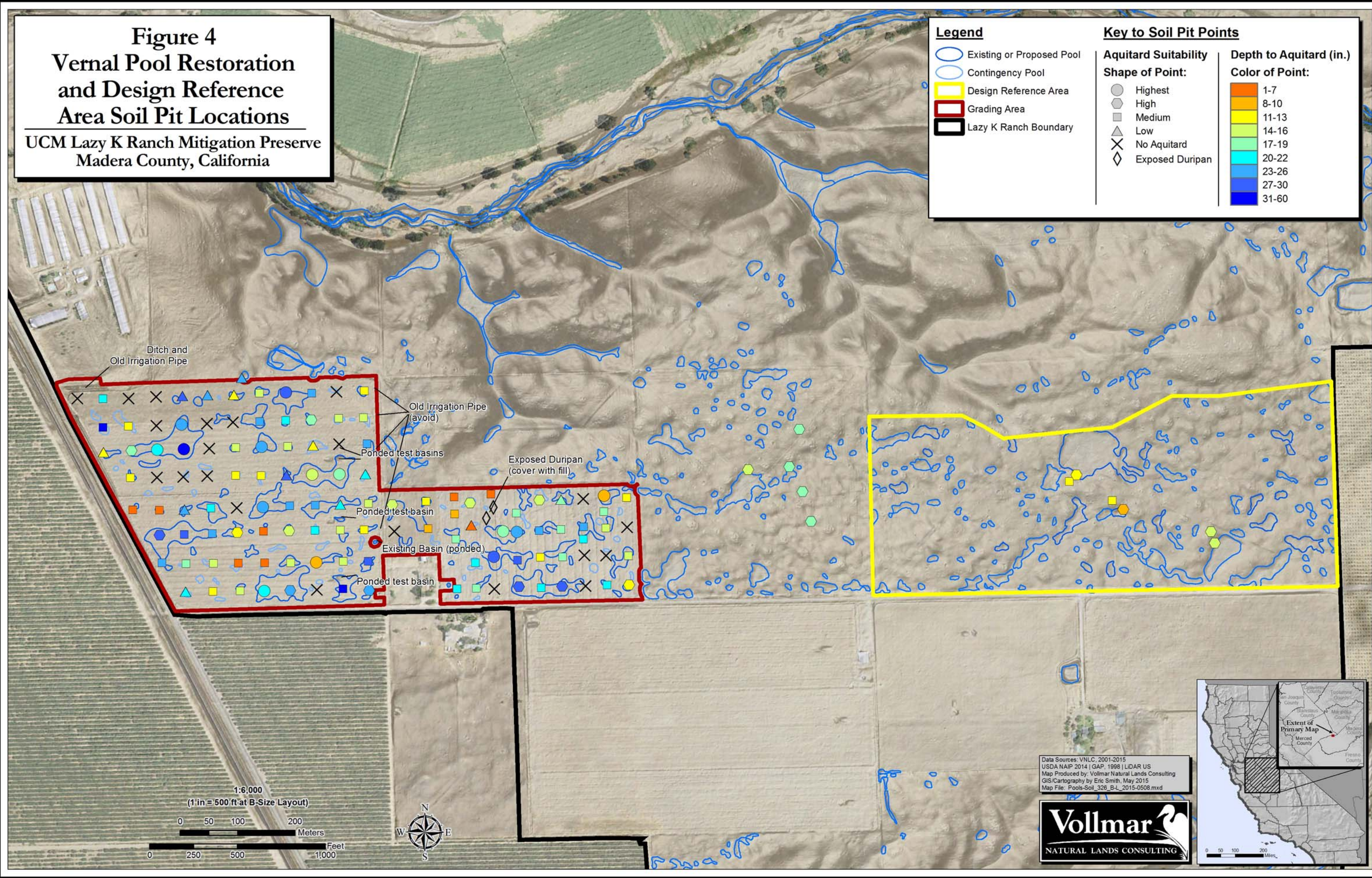

Data Sources: VNLC, 2001-2015
 USDA NAIP 2014 | GAP, 1998 | LIDAR US
 Map Produced by: Vollmar Natural Lands Consulting
 GIS/Cartography by Eric Smith, May 2015
 Map File: Pools-Soil_326_B-L_2015-0508.mxd



removed or disrupted the clay layer in parts of the restoration area; we observed it in only about 40% of pits there. We designated pits with intact clays as high priority restoration areas.

In a limited number of restoration-area pits, we observed a layer of heavy clay at least 10 inches thick. When we located such soils, we typically dug additional surrounding pits to determine the extent of the clay “lens” as a good substrate for a large restored pool. We designated such areas as top-priority for restoration. We assume that similar heavy clays are present in some reference area pools; however this is speculative as we did not excavate within existing wetlands, only in delineated upland areas.

Topography and Surface Hydrology Analysis

We analyzed the existing topography, elevation and surface hydrology patterns in the design reference area (**Figure 5**). We calculated a wetland density of approximately 15% within the reference area based on a formal wetland delineation. This was the target wetland density for the restoration area. Our analyses revealed the general surface flow patterns and hydrological connectivity among the natural pools and swales. The flow generally heads from east to west, though there are some swales that head east, south, or north, indicating that the overall area has a subtle convexity.

Within the restoration area, we analyzed the existing topography and found that though the area had been leveled, there were some subtle topographic features to be considered in the restoration design. We also identified existing swales conveying water on and off the restoration area. Lastly, in spring 2009, we excavated 10 hydrology test basins across the leveled areas on the ranch and monitored ponding during the following rainy season. Eight of the 10 basins ponded for a prolonged period, one drained shortly after it filled (within a few days), and one drained immediately. Four of the test basins were within the UCM project area; all four of these held water successfully. Based on these data, we estimated we will have a hydrologic success rate within the restored vernal pools of 80-90%.

Macro-swale versus Mound Area Analysis

Our topography and surface hydrology analyses of the design reference area revealed a pattern in the distribution and density of vernal pools. We divided the landscape into “macro-swales” and “mound areas” (**Figure 6**). The macro-swales are sinuous low areas that meander across the landscape, generally trending east to west across the site. The mound areas separate the macro-swales, also generally trending east to west across the site. The mound areas are higher-elevation areas containing many mounds, as well as some vernal pools. The macro-swales are not entirely wetland swales, but they contain approximately 80% of the reference area’s wetlands, even though they make up only about 40% of the reference area. Pools in the macro-swales tend to be sinuous in shape, medium to large in size, and closely spaced. In contrast, pools in the mound areas tend to be small, isolated, and oval in shape. We incorporated similar macro-swales and mound areas in the restoration design to mimic the natural landscape (**Figure 6**).

Cut-Fill Balance

We have balanced the cut and fill volumes in the restoration design so that there is a net zero change in volume, with no soil being exported or imported. We targeted this balance in our macro-swale/mound area design because we believe the prior land leveling also had a net zero volume change. By balancing

Figure 5 Vernal Pool Restoration and Design Reference Area Elevation and Hydrology

UCM Lazy K Ranch Mitigation Preserve
Madera County, California

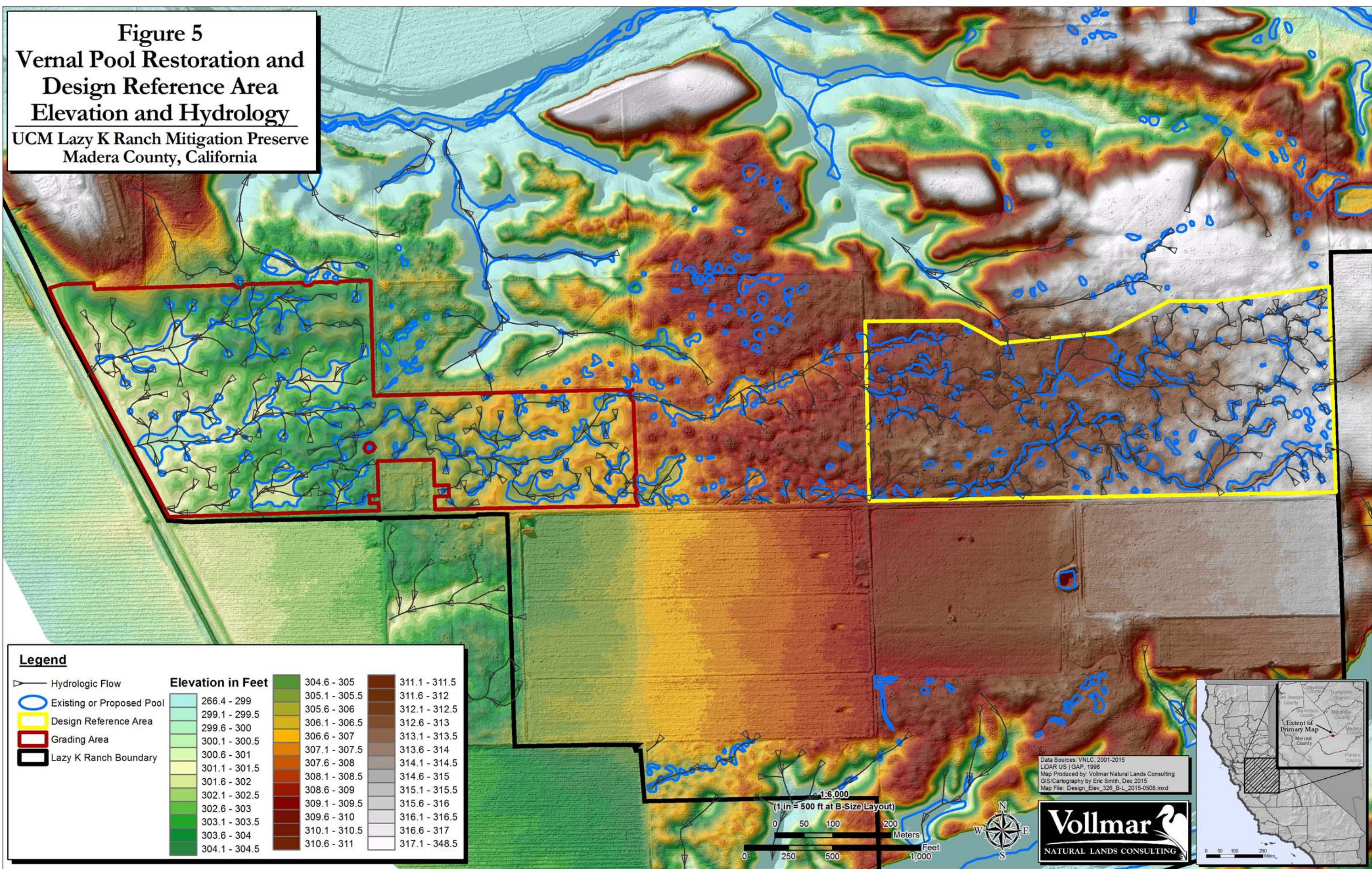

Legend

- Hydrologic Flow
- Existing or Proposed Pool
- Design Reference Area
- Grading Area
- Lazy K Ranch Boundary

Elevation in Feet	
266.4 - 299	304.6 - 305
299.1 - 299.5	305.1 - 305.5
299.6 - 300	305.6 - 306
300.1 - 300.5	306.1 - 306.5
300.6 - 301	306.6 - 307
301.1 - 301.5	307.1 - 307.5
301.6 - 302	307.6 - 308
302.1 - 302.5	308.1 - 308.5
302.6 - 303	308.6 - 309
303.1 - 303.5	309.1 - 309.5
303.6 - 304	309.6 - 310
304.1 - 304.5	310.1 - 310.5
	310.6 - 311
	311.1 - 311.5
	311.6 - 312
	312.1 - 312.5
	312.6 - 313
	313.1 - 313.5
	313.6 - 314
	314.1 - 314.5
	314.6 - 315
	315.1 - 315.5
	315.6 - 316
	316.1 - 316.5
	316.6 - 317
	317.1 - 348.5

Data Sources: VNLC, 2001-2015
LIDAR US | GAP, 1998
Map Produced by: Vollmar Natural Lands Consulting
GIS/Cartography by Eric Smith, Dec 2015
Map File: Design_Elev_326_B-L_2015-0508.mxd

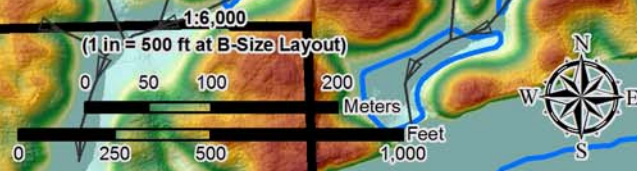
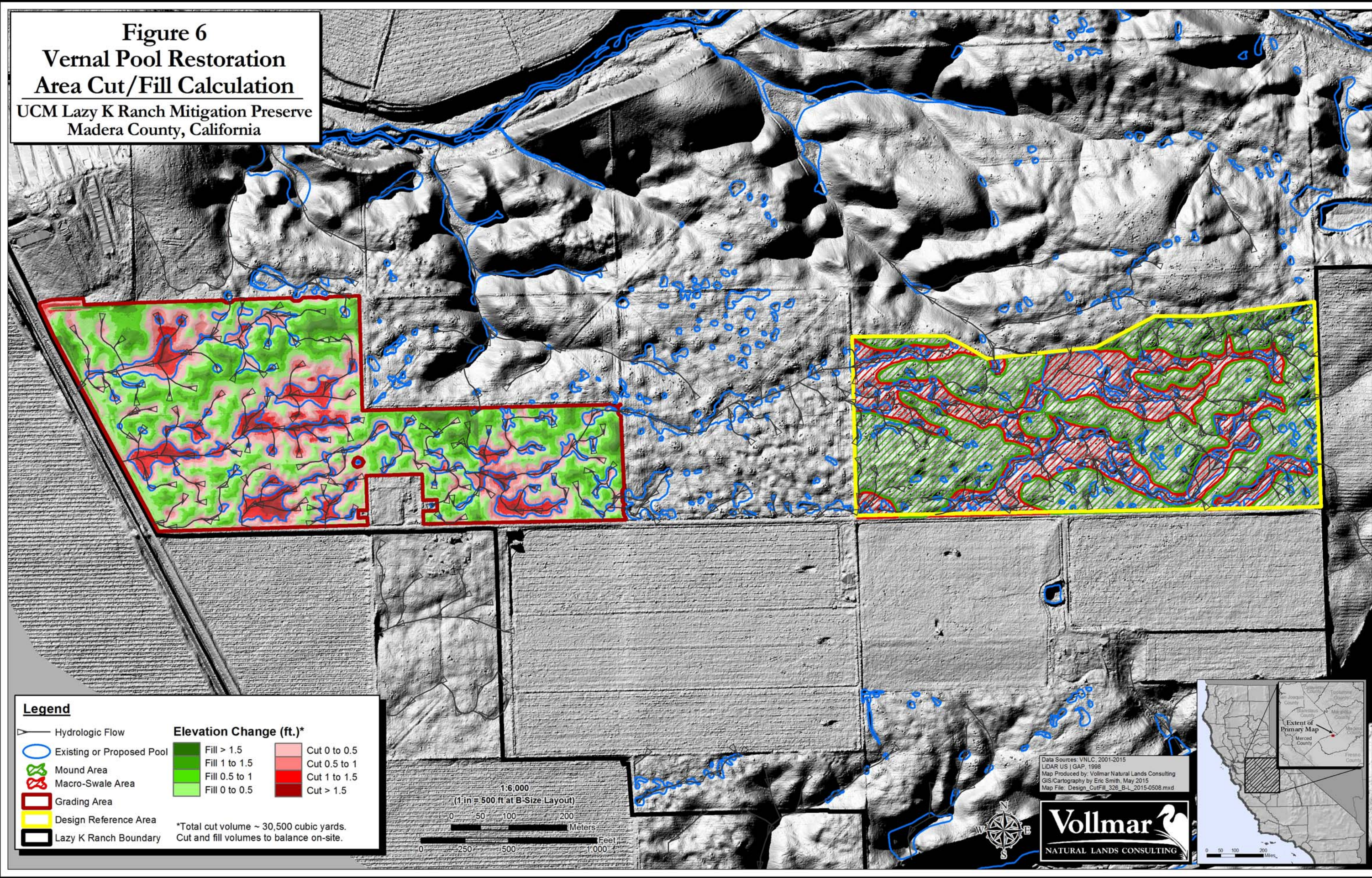

Figure 6
Vernal Pool Restoration
Area Cut/Fill Calculation
 UCM Lazy K Ranch Mitigation Preserve
 Madera County, California



Legend

- Hydrologic Flow
- Existing or Proposed Pool
- Mound Area
- Macro-Swale Area
- Grading Area
- Design Reference Area
- Lazy K Ranch Boundary

Elevation Change (ft.)*

	Fill > 1.5		Cut 0 to 0.5
	Fill 1 to 1.5		Cut 0.5 to 1
	Fill 0.5 to 1		Cut 1 to 1.5
	Fill 0 to 0.5		Cut > 1.5

*Total cut volume ~ 30,500 cubic yards.
 Cut and fill volumes to balance on-site.

1:6,000
 (1 in = 500 ft at B-Size Layout)

0 50 100 200
 Meters

0 250 500 1,000
 Feet

Data Sources: VNLC, 2001-2015
 LIDAR US | GAP, 1998
 Map Produced by: Vollmar Natural Lands Consulting
 GIS/Cartography by Eric Smith, May 2015
 Map File: Design_CutFill_326_B-L_2015-0508.mxd



the soils in the restoration project we can best approximate the original soil depths above the hardpan. Moreover, on-site soil balance is the most efficient use of resources, and avoids costly soil hauling. **Figure 6** shows the areas of proposed cut versus fill by depth class within the restoration area.

Contour Development

The shape of the landscape in the design reference area is complex and subtle, with gentle but constantly-changing slopes. Contours generated automatically by computer design programs lack these nuances, so we drew the contours by hand to mimic the natural variations and shapes of the slopes (**Figures 7A-7C**).

Pool Size Analysis

As described above, the Corps selected a set of 18 natural reference pools within the design reference area that will be used to evaluate the performance of the restored pools (**Figure 3**). The success criteria are based on similarity in ponding depth and duration, floristic diversity and cover, and invasive weed cover. The reference pools were not randomly selected. Rather, pools were selected that exhibited “good” vernal pool habitat characteristics based on cursory field observations during a one-day site visit in April 2014. While the reference pools were selected to include a range of pool sizes, the Corps determined that at least five “large” pools were to be included and “small” pools were to be excluded from the reference set.

Figures 8A and **8B** are histograms that compare the distribution (by number of pools and by area of pools, respectively) of pool sizes among three groups: 1) all pools within the design reference area, 2) the 18 Corps-selected reference pools, and 3) the restored pools as designed. Two characteristics stand out.

First, for all natural pools within the design reference area, the highest proportion by pool number is within the smallest size class (0-0.03 ac.) (**Figure 8A**). However, there are no reference pools within this size class since the Corps excluded small pools. The lack of small pools is compensated for in the next four size classes, all of which have a higher proportion of reference pools than the other two groups. We chose to include restored pools within the smallest size class to more closely mimic the natural size distribution patterns and to achieve a more naturalistic look to the overall design. However, we limited the acreage in this class to less than 10% of the total restored acreage to minimize potential issues with meeting performance standards. Also, we plan to construct these smaller pools with a maximum potential depth of at least 4 inches to ensure that each has a ponding depth and duration within the range of the reference pools and thus meets the hydrologic performance success criteria.

Second, the proportion of pool area within the 1-2 acre class is much higher for the reference pools than the other two groups (**Figure 8B**). This is due to the inclusion of the largest pool (1.83 acres) in the design reference area within the relatively small set of reference pools, greatly skewing this size class. The effect of this largest pool is much more muted when included among all pools within the design reference area. For the restored pools, there is a much smaller proportion of the total acreage within the largest size class as compared to the other two groups. We chose not to design pools in the largest size class (1-2 acres) since a failure of such a large pool would cause a significant loss of restored pool acreage. Instead, we chose to design a number of ‘medium large’ pools (as shown in **Figure 8B**) which still provide similar large pool habitat but pose less risk of a single catastrophic failure.

Figure 7-A Vernal Pool Design Reference Area Topographic Map

UCM Lazy K Ranch Mitigation Preserve
Madera County, California

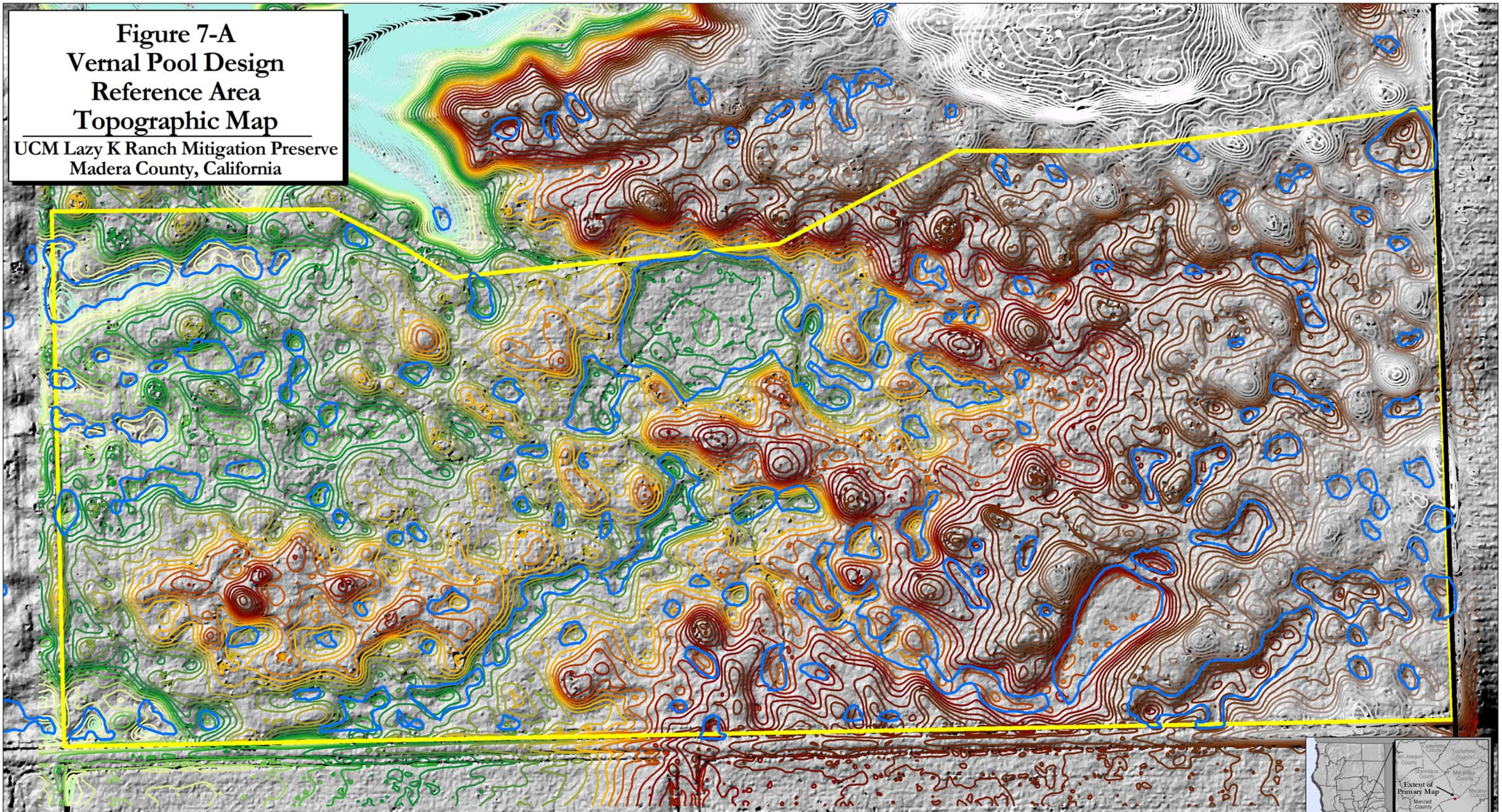

Legend

- Existing or Proposed Pool
- Design Reference Area
- Lazy K Ranch Boundary
- 0.25-ft (3-inch) contours displayed



Data Sources: VNLC, 2001-2015
LIDAR US | GAP, 1998
Map Produced by: Vollmar Natural Lands Consulting
GIS/Cartography by Eric Smith, May 2015
Map File: Design_Topo_R_326_B-L_2015-0508.mxd



Figure 7-B
Vernal Pool Restoration
Area (West)
Topographic Map
 UCM Lazy K Ranch Mitigation Preserve
 Madera County, California

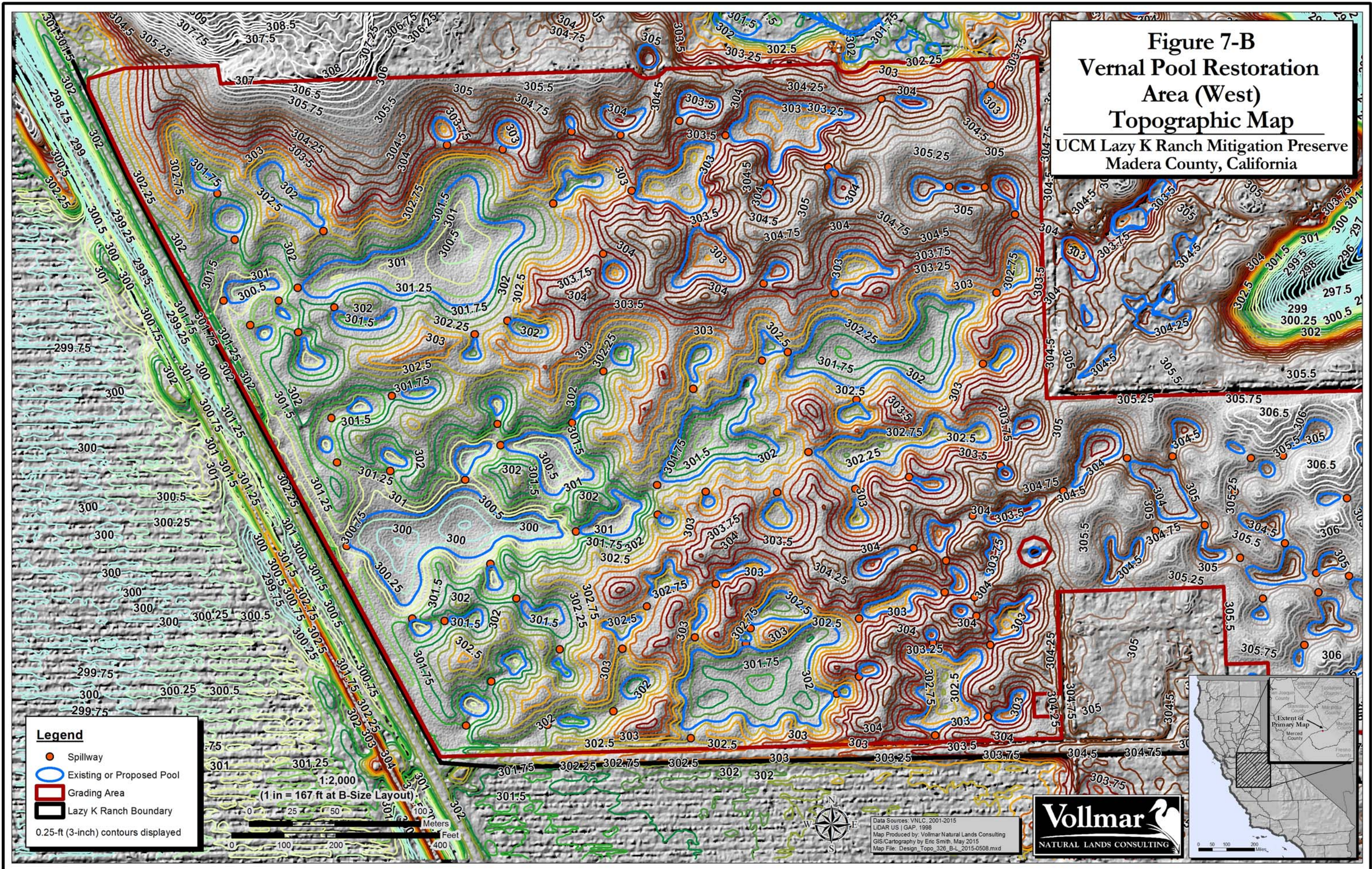

Legend

- Spillway
- ◌ Existing or Proposed Pool
- Grading Area
- Lazy K Ranch Boundary

0.25-ft (3-inch) contours displayed

1:2,000
 (1 in = 167 ft at B-Size Layout)

0 25 50 100 150 200 250 300 350 400
 Meters Feet



Data Sources: VNLG, 2001-2015
 LIDAR US | GAP, 1998
 Map Produced by: Vollmar Natural Lands Consulting
 GIS/ Cartography by Eric Smith, May 2015
 Map File: Design_Topo_326_B-L_2015-0508.mxd

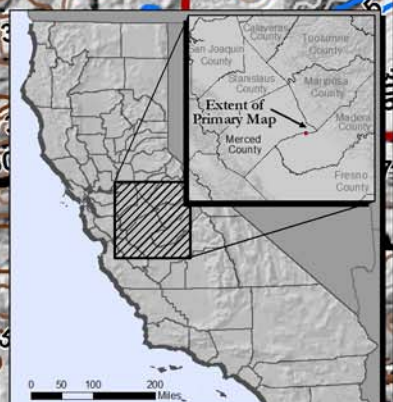
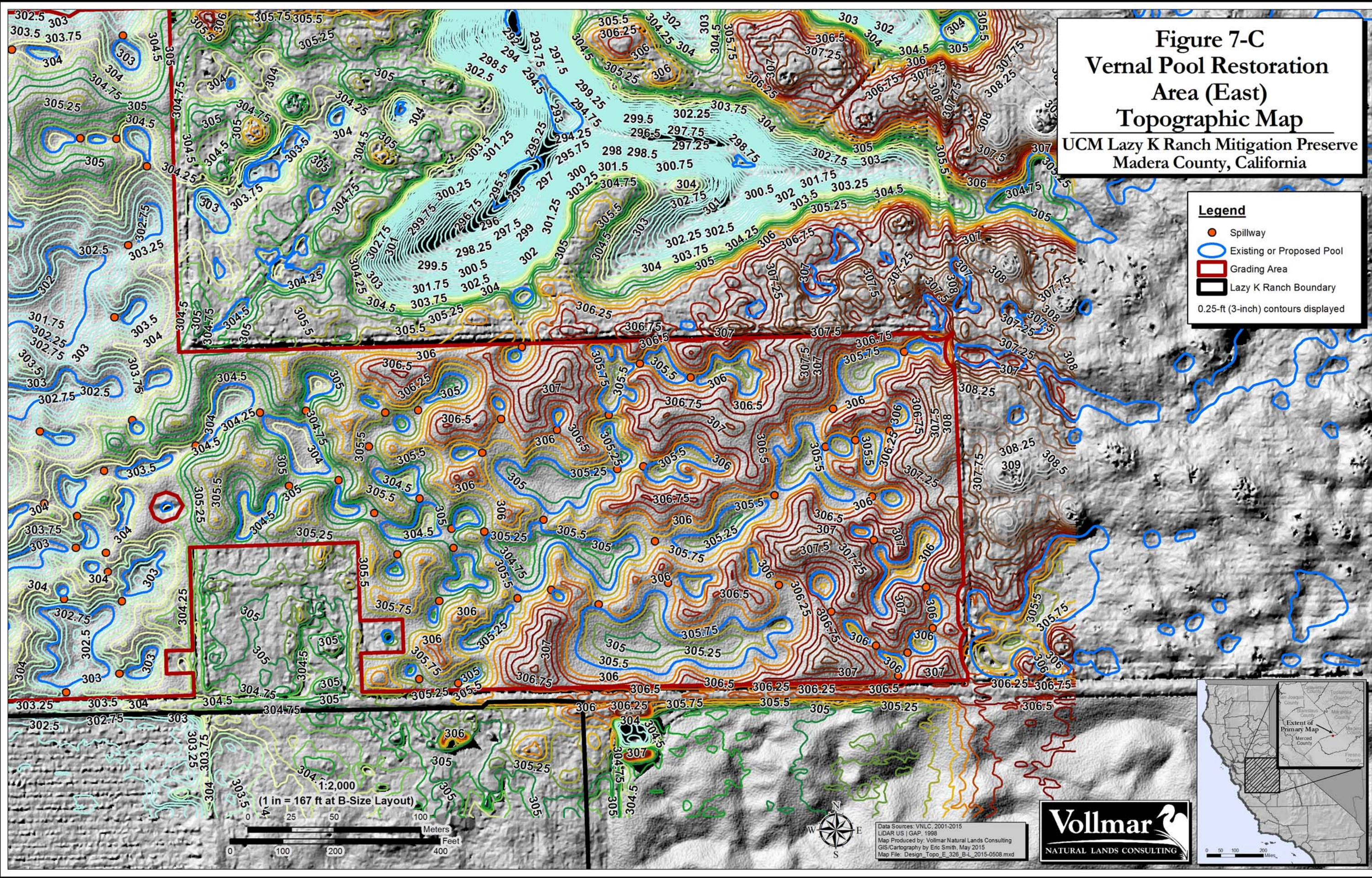

Figure 7-C
Vernal Pool Restoration
Area (East)
Topographic Map
 UCM Lazy K Ranch Mitigation Preserve
 Madera County, California

Legend

-  Spillway
-  Existing or Proposed Pool
-  Grading Area
-  Lazy K Ranch Boundary

0.25-ft (3-inch) contours displayed



1:2,000
 (1 in = 167 ft at B-Size Layout)

0 25 50 100 Meters
 0 100 200 400 Feet



Data Sources: VNLC, 2001-2015
 LIDAR US | GAP, 1998
 Map Produced by: Vollmar Natural Lands Consulting
 GIS/Cartography by Eric Smith, May 2015
 Map File: Design_Topo_E_326_B-L_2015-0508.mxd



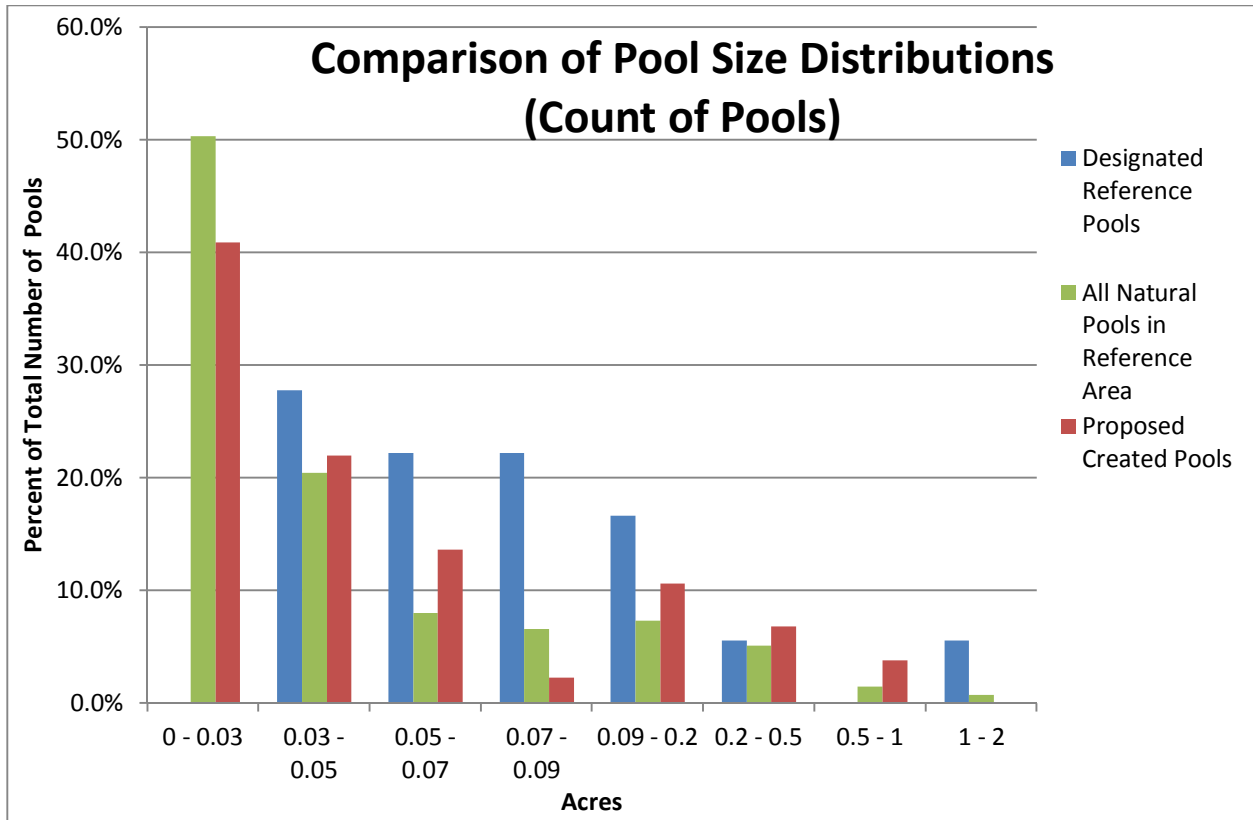

Figure 8-A. Comparison of Pool Size Distributions (Count of Pools)

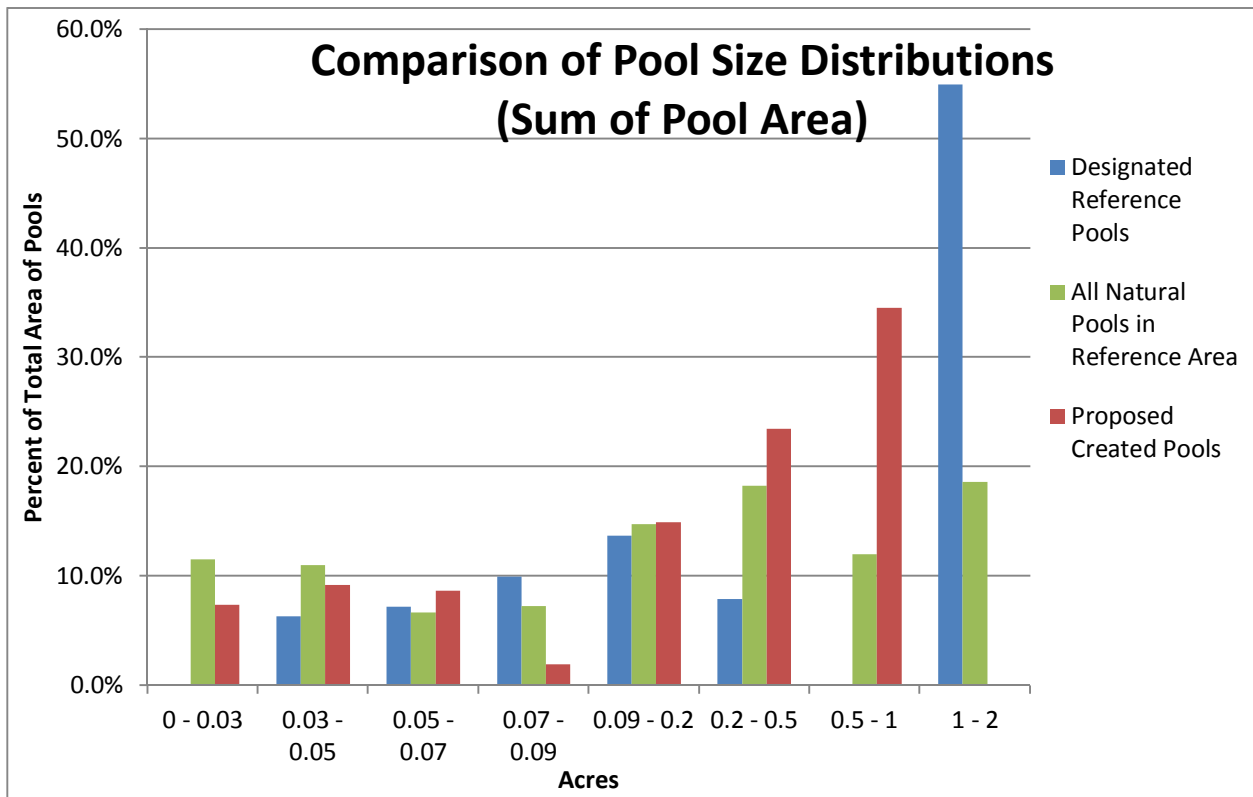

Figure 8-B. Comparison of Pool Size Distributions (Sum of Pool Area)

Pool Depth Analysis

Figure 9 is a histogram that compares pool depth classes among all pools within the design reference area, reference pools, and designed restored pools. As with pool sizes, pool depths in the reference pool set are notably skewed. There are no reference pools in the shallowest depth class (0-3 inches), and few reference pools in the second shallowest class (6-9 inches), even though this class is the most common among natural pools in the design reference area. The success criteria force us to similarly skew our restored pool design in order to meet the hydrology success criteria. Each restored pool has a maximum potential ponding depth between 4 and 18 inches. This is within the range of maximum potential ponding depths among the reference pools. The designed depth generally varies by pool size with depth increasing as pool size increases, as occurs in natural pools. The minimum depth of four inches will ensure that each restored pool will exhibit jurisdictional wetland characteristics and support hydrology suitable for vernal pool indicator plants, provided the pool has a competent hardpan or clay layer that supports suitable hydrology.

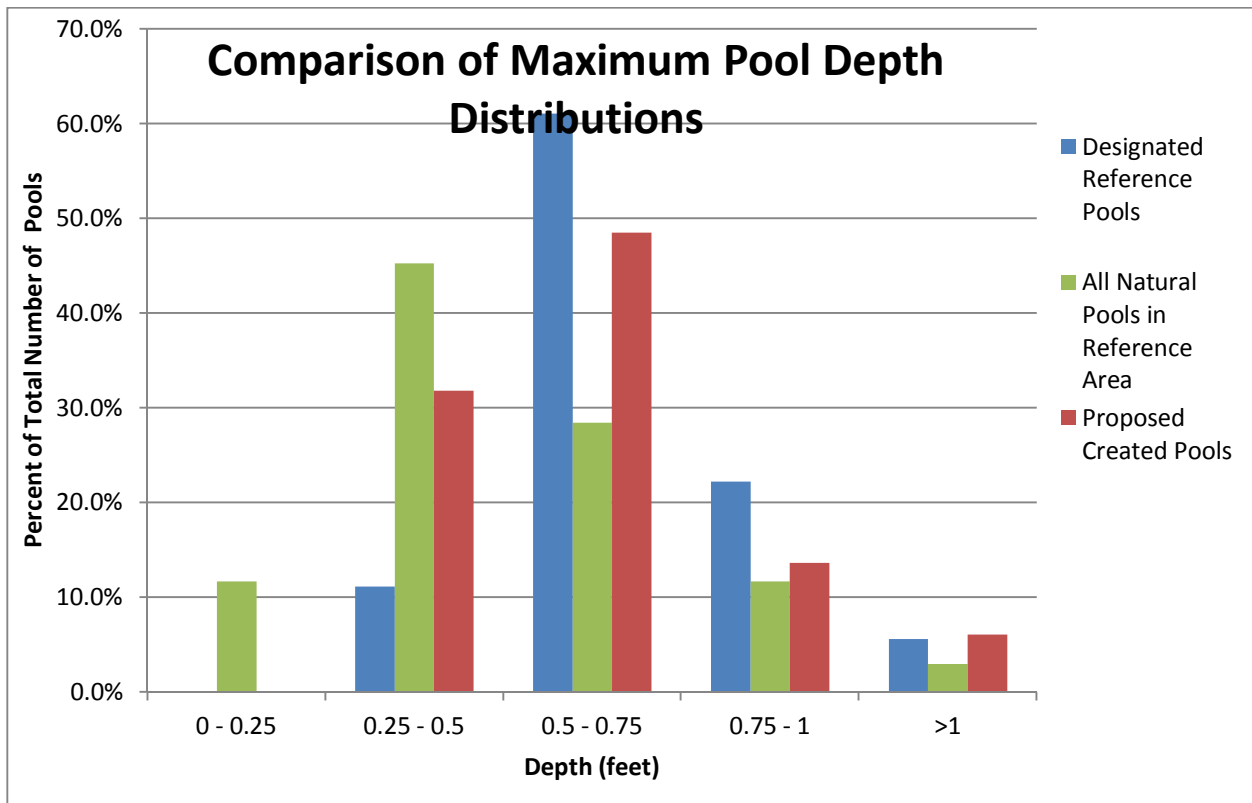

Figure 9. Comparison of Maximum Pool Depth Distributions

Pool Acreage and Contingency Pools

The design reference area has a wetland density of approximately 15%. The restoration area was designed to have a functionally equivalent density. As designed, the restored pools have a density of 16% with a total of 10.5 acres.

Based on our past experience with vernal pool restoration projects, along with the results from the hydrologic test basins, we anticipate that roughly 10-20% of the designed pools will either need to be altered or abandoned during the construction process (due to inappropriate soil conditions) or will fail hydrologically once they are built. To compensate for this, we have included an additional 1.58 acres of 'contingency' pools within the design. These are shown as light blue in **Figure 3**.

Final Restoration Design

Figure 3 shows the final restoration design based on the design elements and considerations discussed above. The figure also shows the distribution of vernal pools within the adjacent design reference site for visual comparison.

The design was constrained to a degree by the need to have the restored pools fall within the size range of the reference pools and by our decision not to build any exceptionally large pools (such as the largest pool reference pool). These factors reduced the number of small pools and eliminated the largest pools as compared to the design reference site. These factors had the effect of decreasing the proportion of the smallest and largest pools and increasing the proportion of medium size pools as compared to the design reference site. As a result, the pools within the final restoration design appear to be more evenly sized and distributed across the site than the design reference site. Nonetheless, the final design appears fairly similar to the design reference site in pool size and distribution and supports a very similar overall density of vernal pools.

4 CONSTRUCTION PROCESS

Construction of the restoration design will be conducted through a series of sequential steps as described below. This process may be modified based on recommendations from the construction contractor if approved by the vernal pool design team. Prior to the start of construction, the construction contractor will meet with the vernal pool design team to discuss the construction process. Also, the design team will provide the construction contractor with digital data of the restoration design which the contractor can use to with GPS units to guide the contouring work. Monitoring biologists will be present at all times during the construction activities to check final grades and ensure that impacts to sensitive resources on or adjacent to the site are avoided.

Key Information

This project differs from typical grading projects in several particulars. These key factors for a grading contractor to be aware of are:

- Soil Constraints,
- Design Flexibility,
- Smooth, Gentle Slopes, and
- Accurate Spillway and Pool Depth Elevations.

Each of these factors is briefly described below.

Soil Constraints

The success of the project depends on intact water-restricting soil layers (including hardpan and clay layers) beneath pools. While we have designed the grading plan to preserve these layers to the best of our ability, it is certain that in some locations our plans will conflict with actual soil conditions. The equipment operators must be sensitive to the soil conditions, and if the grading plans call for digging into clays or hardpan, the operators should alert the Biological Monitor. Conversely, if the soils at a planned pool location are sandy or permeable, the operators should alert the Biological Monitor of that as well.

Design Flexibility

If soil conditions or other unexpected issues create a situation where the design should be modified, the grading contractor must be ready to work with the Biological Monitor to adapt to these conditions. Such changes might include, for example, expanding a pool if heavy clays are present; making a pool shallower if the hardpan is nearer the surface than expected; turning a pool into a mound if the soils are unexpectedly permeable; or even creating entirely new pools and swales as the conditions dictate.

Smooth, Gentle Slopes

The slopes within the Design Reference Area range from approximately 0% to 6.5%, with an average slope of only 2.7%. The grading contractor should be prepared to restore a landscape with these gentle slopes, as reflected in the grading plans. Moreover, any sharp cuts or sudden drops will be out of place in a naturalistic vernal pool landscape, and will be likely to result in erosion. All steep slopes and sharp angles must therefore be scraped clean prior to project completion.

Accurate Spillway and Pool Depth Elevations

It is critical that all created pools pond in the designated depth range of approximately four to 15 inches. Pools shallower or deeper than this are likely to receive no mitigation credit, so accurate relative elevations from the pool bottom to spillway are critical. Elevations of mounds and other features are less important, and can be field-adjusted to ensure on-site soil balance.

Sequential Construction Steps

The assumed construction workflow is as follows:

- 1) Select a 10- to 20-acre Restoration Block

The construction will be conducted in 10- to 20- acre blocks across the project site. The construction contractor and biological monitor will meet at the start of construction to determine the size and sequence of blocks to be constructed.

- 2) Scrape and Stockpile the Top ¼-1/3 Foot of Topsoil from the Block

The top 0.25-0.33 foot of topsoil from the selected block will be scraped and stockpiled in a convenient location within the project site. This topsoil will be distributed back across the block after other grading is completed.

3) Rough Grade and Contour the Surface of the Block as Designed

The surface of the entire block will be graded and contoured per the topographic design. The grade will be established 0.25 foot lower than the design elevations to accommodate replacement of the topsoil after rough grading is complete. The grading and contouring will be guided RTK- GPS units, and spot-checked by the monitoring biologist using a laser transit and stadia rod. Grade tolerance for the pool basins and swales, especially at pool bottoms and spillway points, is ± 0.1 foot. Grade tolerance for upland areas is ± 0.2 foot. Grading of the swales and pool spillways needs to be done carefully to avoid over-cutting and replacing soil in these areas. This will reduce potential for later erosion from water flow, and help avoid inadvertent damage to the hardpan. As described above, the design may be subject to on-the-fly changes at this stage to adapt to soil conditions.

Rough grading may be accomplished with self-loading scrapers or via other means as the contractor deems appropriate. However, if rippers are used as part of this process to loosen soil for the scrapers, it is critical that the soils are not ripped deeper than they will be graded, as this could result in inadvertent damage to the hardpan.

4) Compact Fill Soil

Fill soil (i.e. in upland mounds and ridges) will be lightly to moderately compacted by track-rolling or wheel-rolling with heavy equipment. This will be performed to reduce erosion and reduce water-holding capacity of the upland soils. Note that this stage does *NOT* require “full compaction” with vibratory or other compacting equipment. The objective is naturalistic soils, neither structurally hardened nor loose and fluffy.

5) Smooth the Block Surface

Drag the entire surface of the block to knock down soil chunks, remnant blades cuts, etc. to leave a smooth, ‘natural-looking’ surface.

6) Lightly Harrow or Rip the Block Surface

Lightly harrow or rip the entire block surface to prepare it for the topsoil replacement. The drag lines should follow contours, especially in the pool basins, to reduce potential for erosion down drag lines.

7) Spread Stockpiled Topsoil across Block Surface

The topsoil needs to be evenly spread across the entire block surface to be sure that all areas have a covering of at least 0.25 foot of topsoil. This will ensure a good growing surface for plants.

8) Finish-Grade Topsoil

Ensure the replaced topsoil is spread smoothly and evenly, without sharp angles, bare spots, and without filling pools too deeply.

9) Gently Compact Block Surface

Use appropriate equipment to gently compact the entire block surface. This will reduce potential for erosion during the rainy season as well as soil loss to wind.

10) Select the Next Block for Grading

Continue across the project site, block by block, until the entire project site has been contoured. Ensure smooth transition and grading along the borders between adjacent blocks so that the final constructed surface is a single, integrated landscape.

5 CUT-FILL CALCULATION

Based on the design contours, we anticipate that the project will require approximately 30,500 cubic yards of soil cut, with an equivalent amount of fill to balance. There will be no import or export of soil.

6 PROJECT PERMITS

The project will operate under the terms and conditions of several environmental permits. These include:

- Biological Opinion for Federally-listed Species
- Incidental Take Permit for State-listed Species
- County Grading Permit
- Air Quality Permit
- Stormwater Pollution Prevention Plan (SWPPP)

The first two permits will be acquired by UCM prior to the start of construction. The remaining three permits will be acquired by the construction contractor prior to the start of construction. The construction contractor is responsible abiding by the terms and conditions of all these permits.

7 EQUIPMENT STAGING AND WATER

There will be a designated equipment staging area located on the Lazy K Ranch near the center of the project site along Avenue 28. The staging area will be marked on project maps. Equipment and vehicles can be stored in this area overnight. Water for dust control can be obtained from a well located on the Lazy K Ranch. The well location will also be marked on project maps.

8 ENVIRONMENTAL AWARENESS TRAINING

The areas to the north and east of the project site support natural vernal pools and grasslands with numerous associated special-status species and sensitive wetland habitats. Construction vehicles and personnel are prohibited from entering these areas during the course of the project. Some of these species also may use the project site for upland foraging and sheltering, especially California tiger salamander and Swainson's hawk. San Joaquin kit fox, western burrowing owls, and badgers are other special-status species with potential to use the project site for foraging or denning but have not been observed in the project area and thus are not expected to occur on site.

Adult and juvenile California tiger salamanders use small mammal burrows for sheltering. All of the burrows on the project site will be excavated and collapsed prior to the start of construction. Thus, this species is not expected to occur on the site during the construction activities. Nonetheless, there is potential for individual salamanders to wander onto the project site during the night and shelter under staged equipment or other items providing cover. Construction workers need to be aware of the potential for occurrence of this species and measures to take if an individual is observed.

Swainson's hawks nest in the nearby trees along the Chowchilla River and use the adjacent grasslands for hunting squirrels and other prey. This species is not expected to occur on the project site during construction activities but construction workers should be aware of the potential for occurrence of this species and measures to take if an individual is observed.

Prior to the start of working on the project site, all construction personnel are required to participate in an environmental awareness training provided on site by the monitoring biologist. The biologist will hand out materials with photographs of the special-status species with potential to occur on site and discuss the best management practices to be followed to avoid potential impacts to these species.

9 BEST MANAGEMENT PRACTICES

The construction contractor will adhere to the following best management practices (BMPs) during the course of project:

1. Construction is permitted from one hour after sunrise to one hour before sunset.
2. A maximum speed limit of 15mph must be observed on the project site and along Avenue 28.
3. Construction vehicles must proceed with caution when entering or exiting Santa Fe Drive.
4. The construction contractor will develop a dust control plan that adheres to the terms and conditions of the air quality permit and grading permit, and will spray water on construction areas as needed to adequately control dust.
5. No machinery or workers can enter the non-construction portions of the project site.
6. Prior to the beginning of work on the site, all construction personnel will receive environmental awareness training and informational materials by a monitoring biologist on the sensitive species and habitats present on the project site. This presentation will also include potential penalties for not complying with avoidance measures.
7. The monitoring biologist will stop construction activities if situations arise that present a threat to sensitive species or sensitive habitats on the project site. Construction activities will resume after corrective measures have been taken as deemed appropriate by the monitor.
8. If the monitor believes that an unauthorized take has occurred of a listed species, all construction activities will be halted immediately and the monitor will notify USFWS and/or CDFW. Activities will continue only after agency approval.
9. Erosion will be controlled during construction activities by grading during the dry season and utilizing natural/biodegradable erosion control measures (e.g., straw wattles, hay bales) as needed to prevent sediments from entering existing wetlands.
10. Construction vehicles and equipment will be staged when not in use in a designated staging located along Avenue 28. This area will be marked on construction maps. All refueling and maintenance activities will occur within this staging area and all machinery will be parked in the staging area over night.

11. Construction equipment and vehicles need to be maintained in adequate condition to avoid inadvertent leakage of oil, gas, or hydraulic fluids. Any leaks or spills must be cleaned up immediately, and hazardous materials disposed of appropriately.
12. To avoid wildfires, smoking shall be restricted to a designated area within the equipment staging area or in the enclosed cab of a construction vehicle.
13. The site shall remain free of trash and excess accumulated debris during the construction process. A trash bin or other trash receptacle will be provided as necessary to dispose of trash from lunches, etc.
14. Upon completion of the overall construction project, all vehicles and equipment shall be removed from the project site as well as all stakes and pin flags placed during the construction process.



BAY AREA OFFICE
1720 Solano Ave
Berkeley, CA 94707
Phone: 510/559-9603
Fax: 510/559-9605
www.vollmarconsulting.com

RESTORATION AND REVEGETATION PLAN

**Lazy K Ranch Permittee-Responsible Off-site Mitigation Preserve,
Madera County, California**

University of California, Merced Project

Prepared for:

University of California, Merced
5200 North Lake Road
Merced CA 95343
Contact: Phil Woods
(209) 228-4481

Prepared by:

Vollmar Natural Lands Consulting, Inc.
1720 Solano Avenue
Berkeley, CA 94707
Contact: John Vollmar
510-559-9603

May 18, 2015

1.0 INTRODUCTION

This document presents a Restoration and Revegetation Plan (RRP) for the upland communities within the 65.5-acre construction footprint of the University of California, Merced (UCM) Project Wetland Restoration Area (WRA) on the Lazy K Ranch permittee-responsible mitigation preserve (**Figure 1 and 2**). Following wetland construction, this RRP will be implemented in temporarily disturbed upland areas. The WRA is being established to restore the historic mound-basin topography, and associated vernal pools and swales to mitigate for vernal pool wetland losses resulting from development of UCM Campus. This area historically supported mound-basin topography and associated vernal pools and swales but was leveled for agriculture prior to the 1950s. The proposed wetland restoration will restore a semblance of the historic mound-basin topography and 10.5 acres of vernal pool wetlands. The restoration design is based on a nearby ‘design reference area’ on the ranch with intact mound-basin topography and associated vernal pools (**Figure 2**).

The Lazy K Ranch is located just northeast of the town of Chowchilla, on the border of southeastern Merced and northwestern Madera Counties, California. It is on the east side of South Santa Fe Avenue, south of the intersection with Marguerite Road. Specifically, the ranch is located in Section 1, Township 9 South, and Range 16 E, and Sections 7-9 and 18, Township 9 South, Range 17 East of the Le Grand and Raynor Creek, California 7.5 minute quadrangles. The UCM WRA itself is located in the southwestern area of the ranch, bordered on the south by Avenue 28 and on the west by Santa Fe Drive.

2.0 SITE CONDITIONS

The WRA, though currently leveled, supports annual grasslands that are generally similar in overall cover and species diversity as the annual grasslands in the adjacent Preservation Area. Overall, the WRA is relatively free of major infestations of invasive plant species, which is due in large part to the diligence of the Property Owners in eradicating or controlling incipient populations. The WRA is currently managed as dry pasture used for livestock grazing.

The annual grasslands in the WRA are dominated by several naturalized non-native annual grasses, including soft chess (*Bromus hordeaceus*), ripgut brome (*B. diandrus*), and slender oats (*Avena barbata*). Other common grass species present include foxtail barley (*Hordeum leporinum*), red brome (*B. rubens* ssp. *madridentis*), and rattail fescue (*Festuca myuros*). Low-lying seasonally moist areas are dominated by Italian ryegrass (*Festuca perennis*) and Mediterranean barley (*H. marinum* var. *gussoneanum*). Common native herbs include blow wives (*Achyrachaena mollis*), miniature lupine (*Lupinus bicolor*), slender tarweed (*Holocarpha virgata*), smooth cat’s-tongue (*Hypochaeris glabra*), dove weed (*Croton setigerus*), and filaree (*Erodium botrys*). No special-status upland plant species or significant stands of native perennial bunchgrasses occur in the UCM WRA. The annual grasslands have a generally low occurrence and cover of invasive plant species.

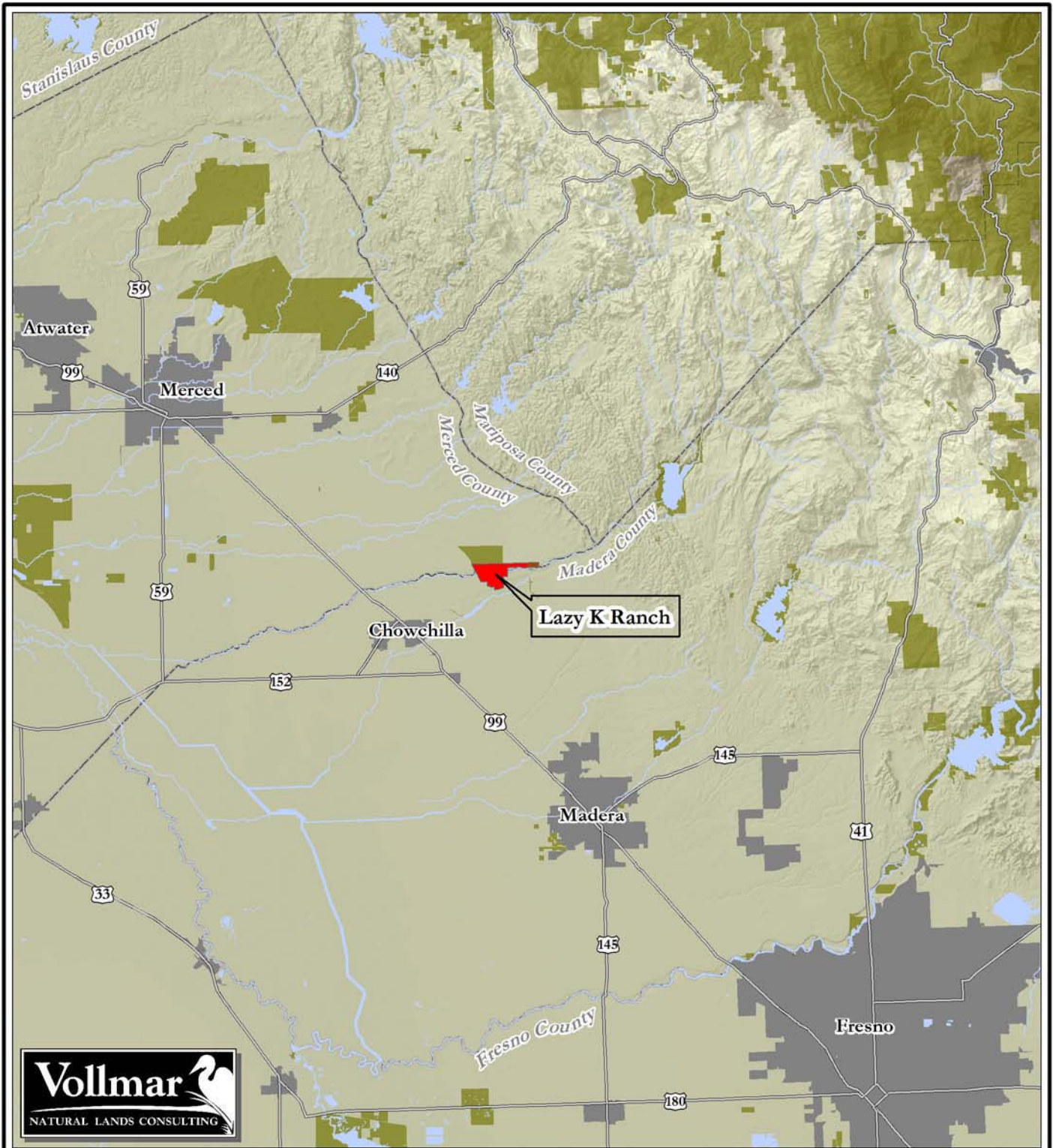

Legend

- Lazy K Ranch
- Public and/or Preserved Land
- Urbanized Area
- Water Body
- River or Major Creek
- Highway

Data Sources: VNL, 2015 | TIGER, 2000 | CPAD, 2012
 USGS, Various | GAP, 1998 | DWR, 2001
 GIS/Cartography by: C. De La Torre, Feb. 2015
 Map File: Vicinity_A-P_2015-0319.mxd

FIGURE 1
Regional Vicinity Map
Lazy K Ranch

Merced and Madera County, California



1:506,880
 (1 inch = 8 miles, at letter layout)

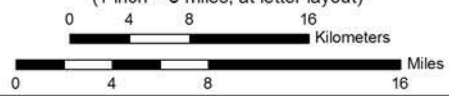
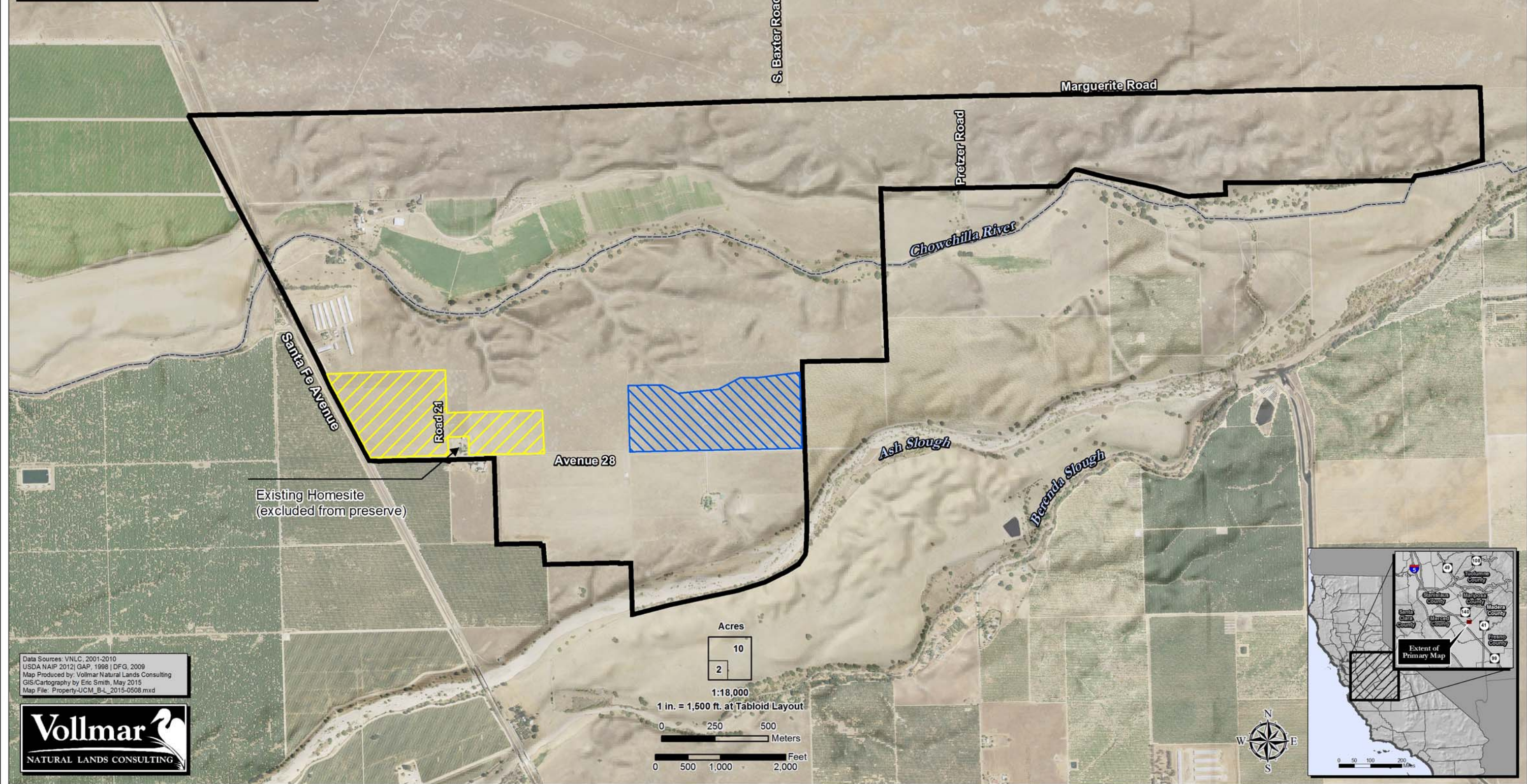

FIGURE 2: Site Map
 UCM Lazy K Ranch Mitigation Preserve
 Madera County, California

Legend

-  UCM Wetland Restoration Area (65.5 ac.)
-  Design Reference Area (63.5 acres)
-  Lazy K Ranch Boundary (1,556 acres)
-  County Boundary



Data Sources: VNLC, 2001-2010
 USDA NAIP 2012 | GAP, 1998 | DFG, 2009
 Map Produced by: Vollmar Natural Lands Consulting
 GIS Cartography by: Eric Smith, May 2015
 Map File: Property-UCM_B-L_2015-0508.mxd



Acres

10
2

1:18,000
 1 in. = 1,500 ft. at Tabloid Layout

0 250 500 Meters

0 500 1,000 2,000 Feet



3.0 AUGMENTATION OF UPLAND AREAS WITH SEED MIX

The construction process for wetland restoration is described in the Final Vernal Pool Restoration Design and Construction Plan for the UCM Project. This process will result in disturbance of soils over nearly the entire 65.5-acre site, ending with approximately 15% cover of vernal wetlands. After grading has been complete, stockpiled topsoil will be re-distributed over the entire graded area. It is anticipated that the process of redistributing the topsoil in a manner aimed at promoting the germination of the existing seed bank will result in significant re-vegetation of the upland communities following project completion. Nevertheless, to ensure a return to pre-project conditions of the vegetative cover of the disturbed upland areas as thoroughly and quickly as possible, the existing seed bank present in the redistributed topsoil will be augmented with the following carefully selected native and naturalized seed mix:

Table 1: Seed Mix

Common Name	Scientific Name	%	*Cal-IPC status	Notes
Native Small Fescue	<i>Festuca microstachys</i>	5.00	Native	Not currently on site
Blando Brome	<i>Bromus hordeaceus</i>	40.00	Non-native, Limited	Abundant at site
Tetraploid Annual Rye	<i>Lolium multiflorum</i>	25.00	Non-native, Moderate	Abundant at site
PK Hykon Rose Clover	<i>Trifolium hirtum</i>	10.00	Non-native, Limited	Occurs on site
Lana Vetch	<i>Vicia villosa</i>	20.00	Non-native, not listed	Occurs on site

* California Invasive Plant Council

In addition to the native small fescue, this seed mix is designed to include only naturalized, non-native species that currently occur in abundance on the site and in the region. They are known to have limited to moderate invasive characteristics and are also appropriate and attractive forage for the grazing livestock on the site.

The seed mix will be applied at a rate of 25 lbs. per acre on all the upland areas of the project site (approximately 85% of the site, or 55.7 acres) just before the first germinating rain. In mid to late winter--after the seed bank and augmentation seeds have sprouted--an additional spot-application will be carried out on any areas that remain bare of vegetation.

4.0 WEED CONTROL MEASURES

The disturbance of the top soil layers has the potential to encourage the establishment of noxious weeds which typically thrive in disturbed environments. A separate weed control plan was prepared for the WRA to address this issue. The following measures, included in the plan, will be taken to reduce the potential for large populations of noxious weeds to become established on the Lazy K Ranch after the restoration activities are completed.

1. Noxious weed surveys will be conducted prior to the initiation of restoration activities. These surveys will establish the current state of noxious weeds on the WRA and ranch, and will indicate areas that may be source populations and will require increased vigilance after restoration is complete. Post-restoration weed surveys will be conducted in conjunction with other monitoring activities.
2. No soil will be imported or exported from the WRA. Topsoil will be replaced as part of the construction process and disturbed areas will also be reseeded with naturalized plant seed (i.e., seed from native and non-native but naturalized grassland plants already on the site) to minimize erosion and invasive plant establishment.

3. Since the entire WRA will be re-graded, we will not be able to avoid any existing invasive plant populations. However, we will take measures to scrape these areas and bury the topsoil as part of the regrading process rather than including it with the stockpiled topsoil that will be redistributed on the site.

5.0 SUCCESS CRITERIA

The performance standard for the implementation of this RRP is that upland vegetation communities in the WRA be statistically similar to pre-disturbance conditions. Absolute vegetative cover and cover of invasive species should fall within two standard deviations of the mean of pre-disturbance conditions.

If these success criteria have not been met by the end of the 10-year post-construction monitoring period, monitoring and control efforts will continue and remedial actions will be identified and implemented until success criteria are met or the agencies have approved conditions.

Monitoring results will help establish if the proper measures are being taken to ensure that the project is establishing adequate vegetative cover and not promoting the introduction and spread of noxious weeds. Responsible parties will practice adaptive management to ensure that the best practices available are being utilized.

6.0 REFERENCES

- California Department of Fish and Wildlife (CDFW). 2014. *California Endangered Species Act Incidental Take Permit No. 2081-2013-025-04* California High-Speed Train Project Merced to Fresno Section Permitting Phase 1.
- U.S. Fish and Wildlife Service (USFWS). 2012. *Biological Opinion on the California High-Speed Train System: Merced to Fresno Section Project, Merced, Madera, and Fresno Counties (08ESMF00-2012-F-0248)*. Sacramento, CA. September 14, 2012.

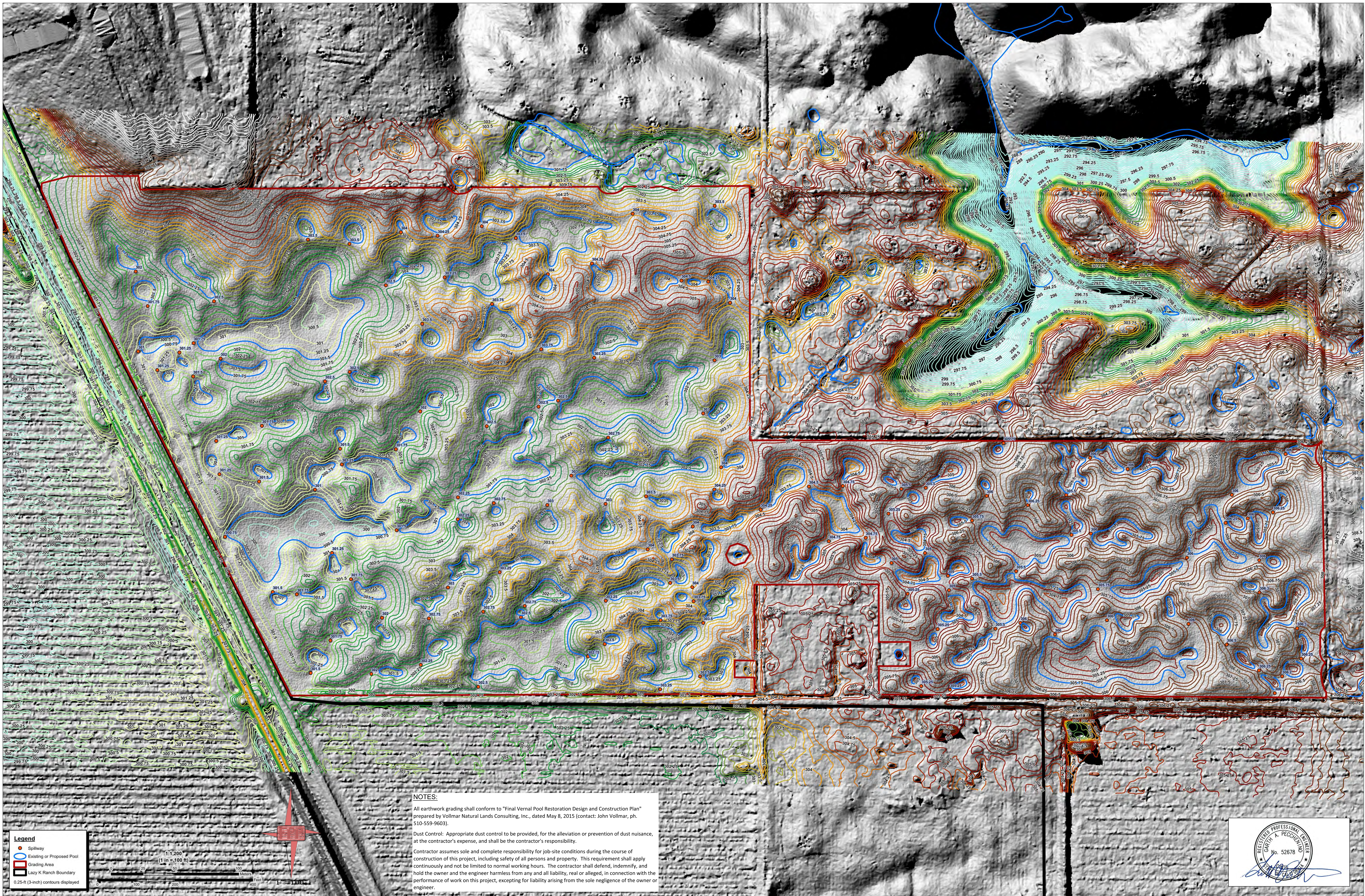

Legend

- Spillway
- Existing or Proposed Pool
- Grading Area
- Lazy K Ranch Boundary

0.25-ft (3-inch) contours displayed

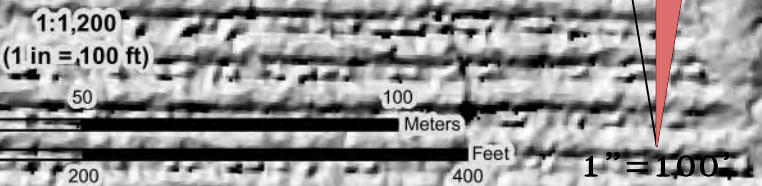

NOTES:

All earthwork grading shall conform to "Final Vernal Pool Restoration Design and Construction Plan" prepared by Vollmar Natural Lands Consulting, Inc., dated May 8, 2015 (contact: John Vollmar, ph. 510-559-9603).

Dust Control: Appropriate dust control to be provided, for the alleviation or prevention of dust nuisance, at the contractor's expense, and shall be the contractor's responsibility.

Contractor assumes sole and complete responsibility for job-site conditions during the course of construction of this project, including safety of all persons and property. This requirement shall apply continuously and not be limited to normal working hours. The contractor shall defend, indemnify, and hold the owner and the engineer harmless from any and all liability, real or alleged, in connection with the performance of work on this project, excepting for liability arising from the sole negligence of the owner or engineer.



Potential Sediment Control Requirement Map

UCM Lazy K Ranch Mitigation Preserve
Madera County, California

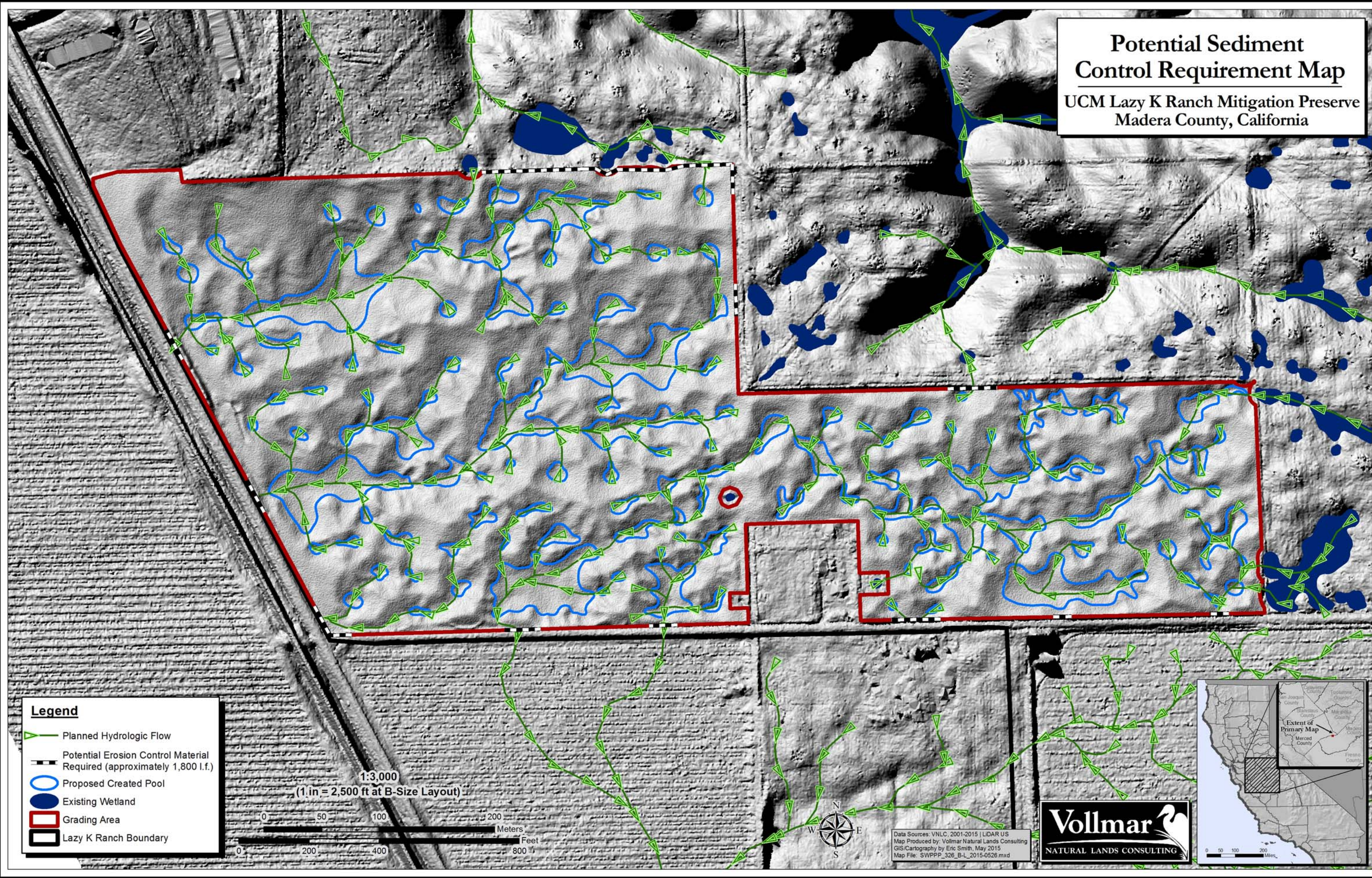

- Legend**
- Planned Hydrologic Flow
 - Potential Erosion Control Material Required (approximately 1,800 l.f.)
 - Proposed Created Pool
 - Existing Wetland
 - Grading Area
 - Lazy K Ranch Boundary

1:3,000
(1 in = 2,500 ft at B-Size Layout)

0 50 100 200 400
Meters

0 200 400
Feet



Data Sources: VNLC, 2001-2015 | LIDAR US
Map Produced by: Vollmar Natural Lands Consulting
GIS Cartography by Eric Smith, May 2015
Map File: SWPPP_326_B-L_2015-0526.mxd

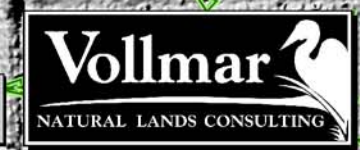

 NORTH
 SCALE: 1"=600"
 0 100 200 400 Feet
 Date: 6/10/2015
 UNIVERSITY OF CALIFORNIA, MERCED
 OFFICE OF PLANNING & BUDGET
 GEOSPATIAL ANALYTICS
 &
 CARTOGRAPHIC SERVICES

Legend:

- Fence to Be Removed (3,074 lf)
- Trough Supply Piping to be Removed (830')
- Trough Supply Piping to be Included (1,240')
- ▶▶▶▶ Flood Irrigation Piping within Project Site (4,098 lf)
- ▶▶▶▶ Irrigation Flow

DRAFT

Drawing Title:
Lazy K: Site Conditions

Drawing Number:
LZYK-01

Notes:
All utility alignments are illustrative and approximate in their location.

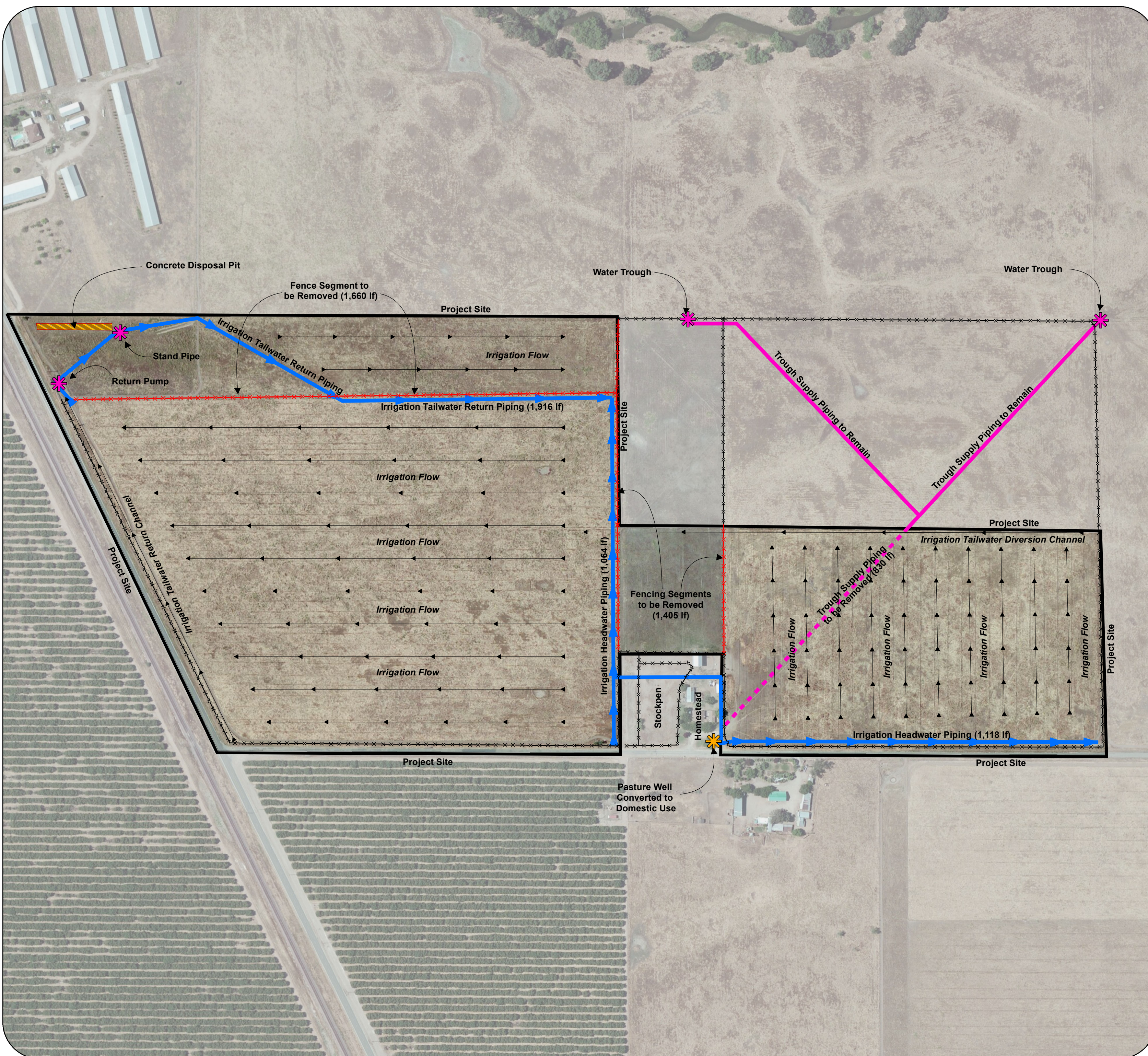

Potential Sediment Control Requirement Map

UCM Lazy K Ranch Mitigation Preserve
Madera County, California

Addendum 2 SWPPP Plan
6/15/2015

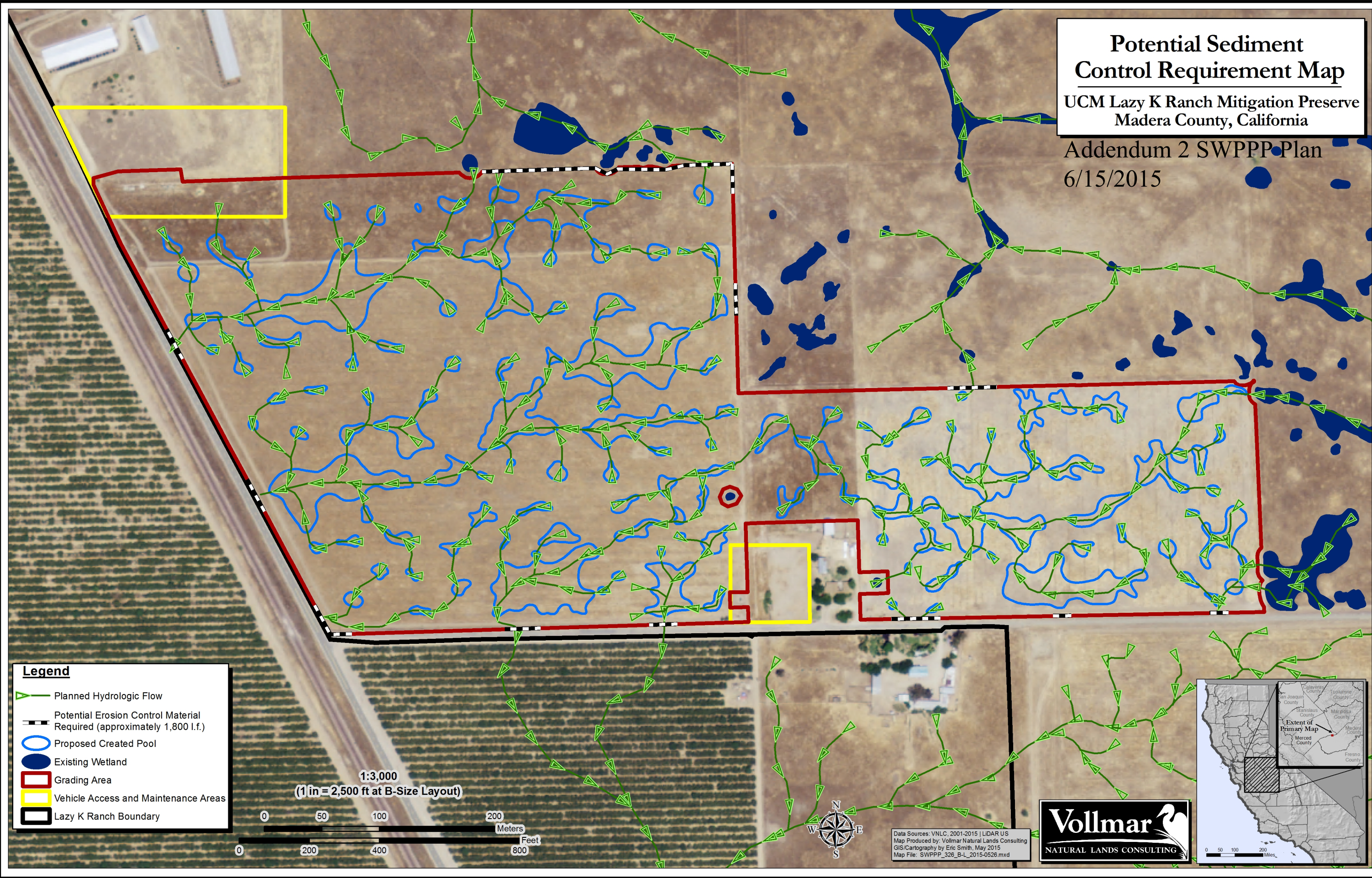

- Legend**
- Planned Hydrologic Flow
 - Potential Erosion Control Material Required (approximately 1,800 l.f.)
 - Proposed Created Pool
 - Existing Wetland
 - Grading Area
 - Vehicle Access and Maintenance Areas
 - Lazy K Ranch Boundary

1:3,000
(1 in = 2,500 ft at B-Size Layout)

0 50 100 200 Meters
0 200 400 800 Feet

Data Sources: VNLC, 2001-2015 | LIDAR US
Map Produced by: Vollmar Natural Lands Consulting
GIS/Cartography by Eric Smith, May 2015
Map File: SWPPP_326_B-L_2015-0526.mxd

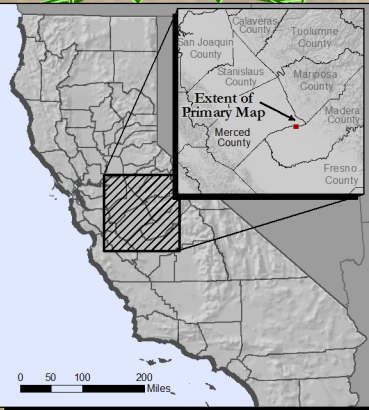
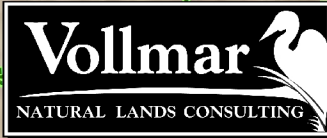

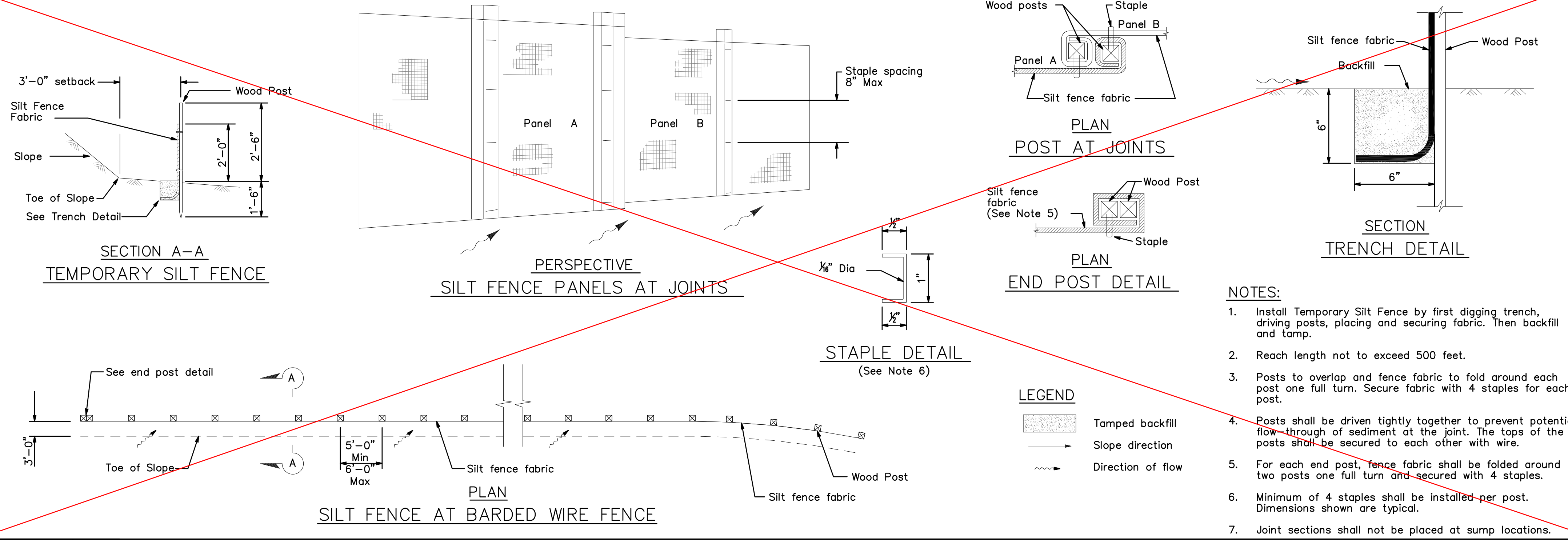

1 TEMPORARY SILT FENCE
N.T.S. REF:

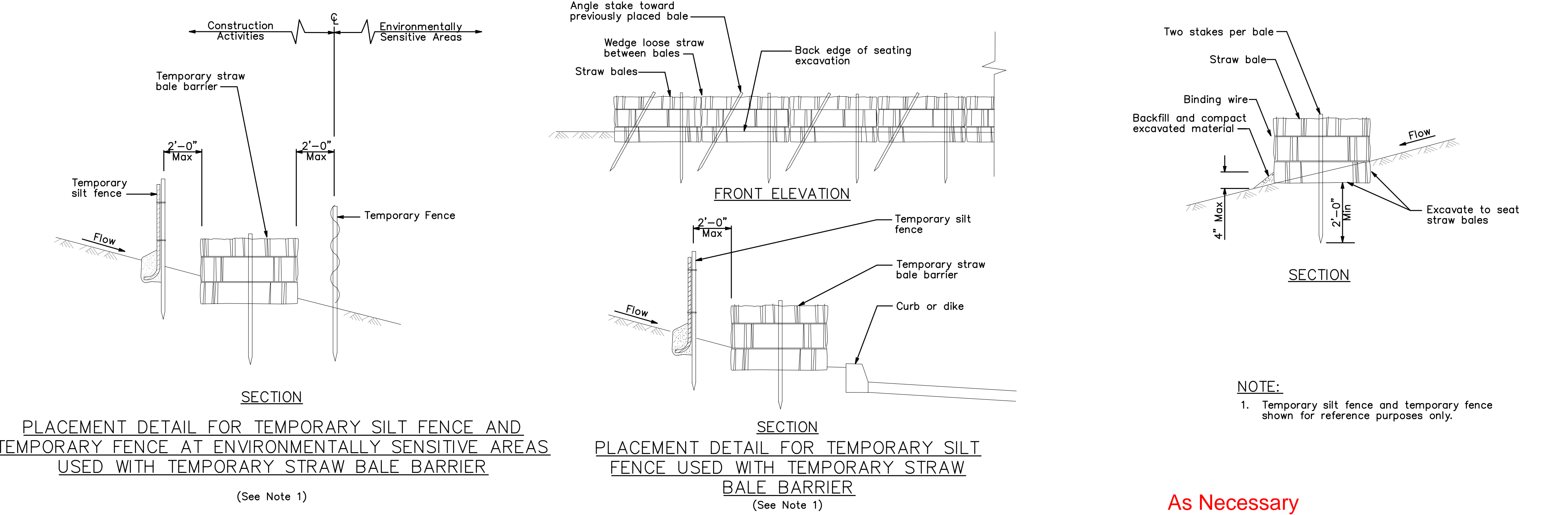

2 TEMPORARY STRAW BALE BARRIER
N.T.S. REF:

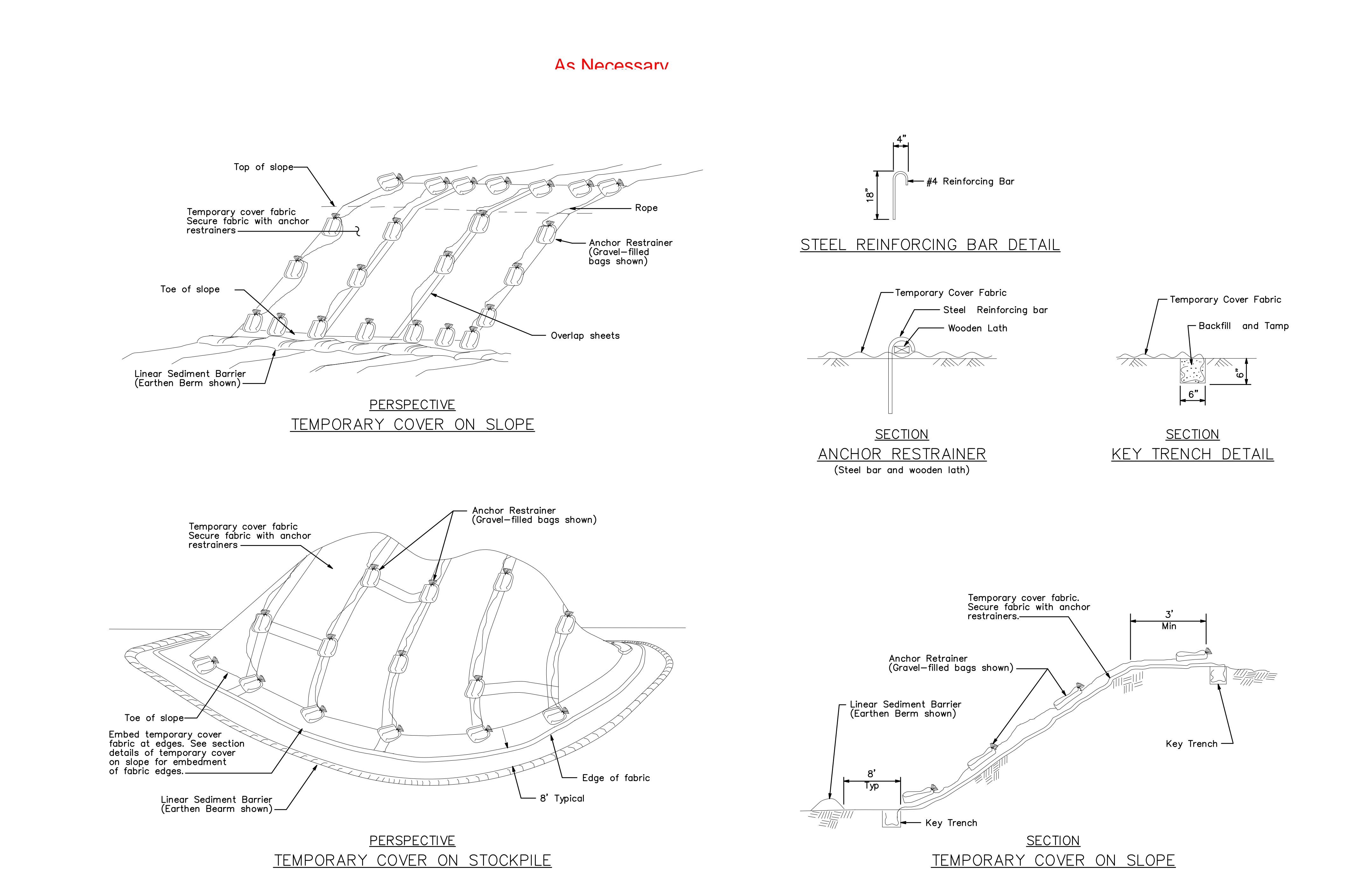

3 TEMPORARY COVER
N.T.S. REF:

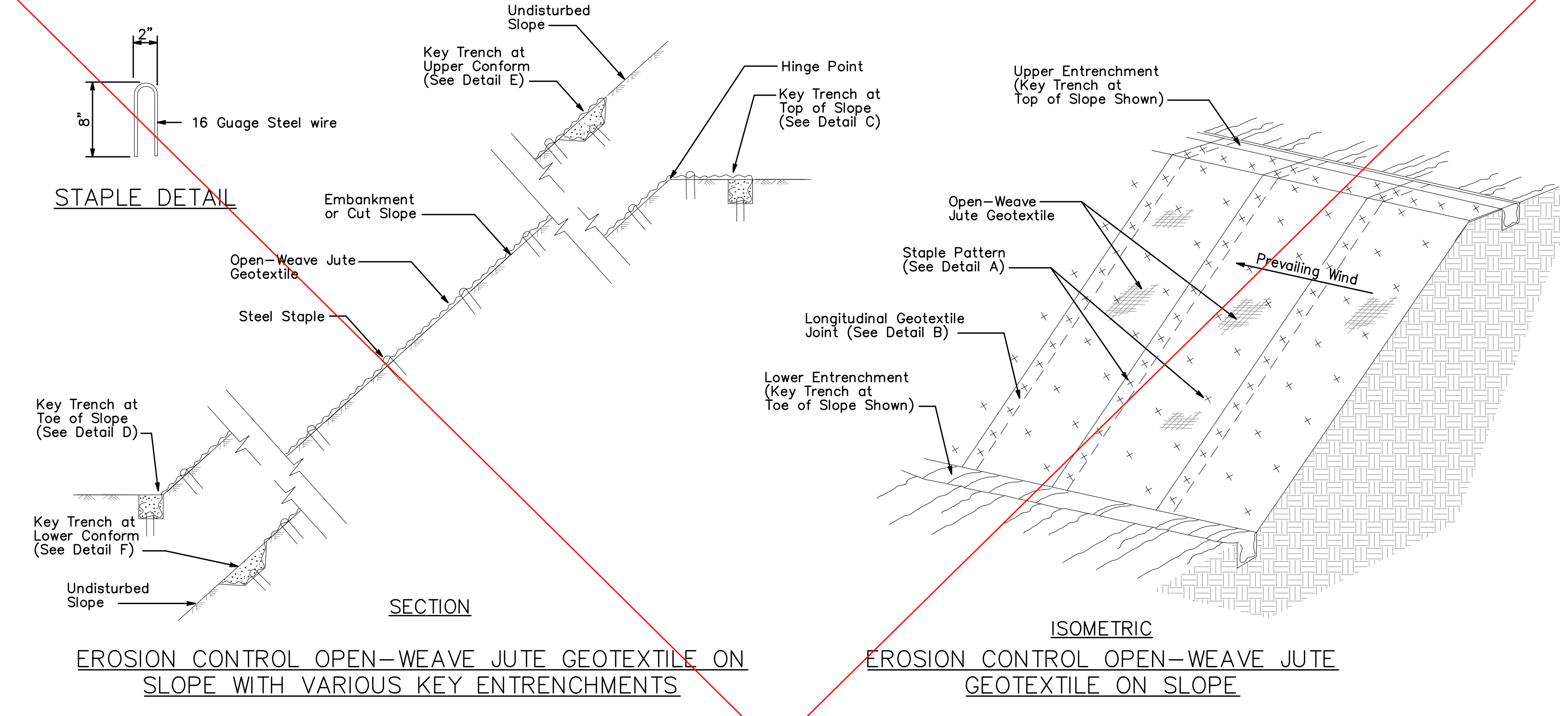

4 OPEN WEAVE JUTE GEOTEXTILE
N.T.S. REF:

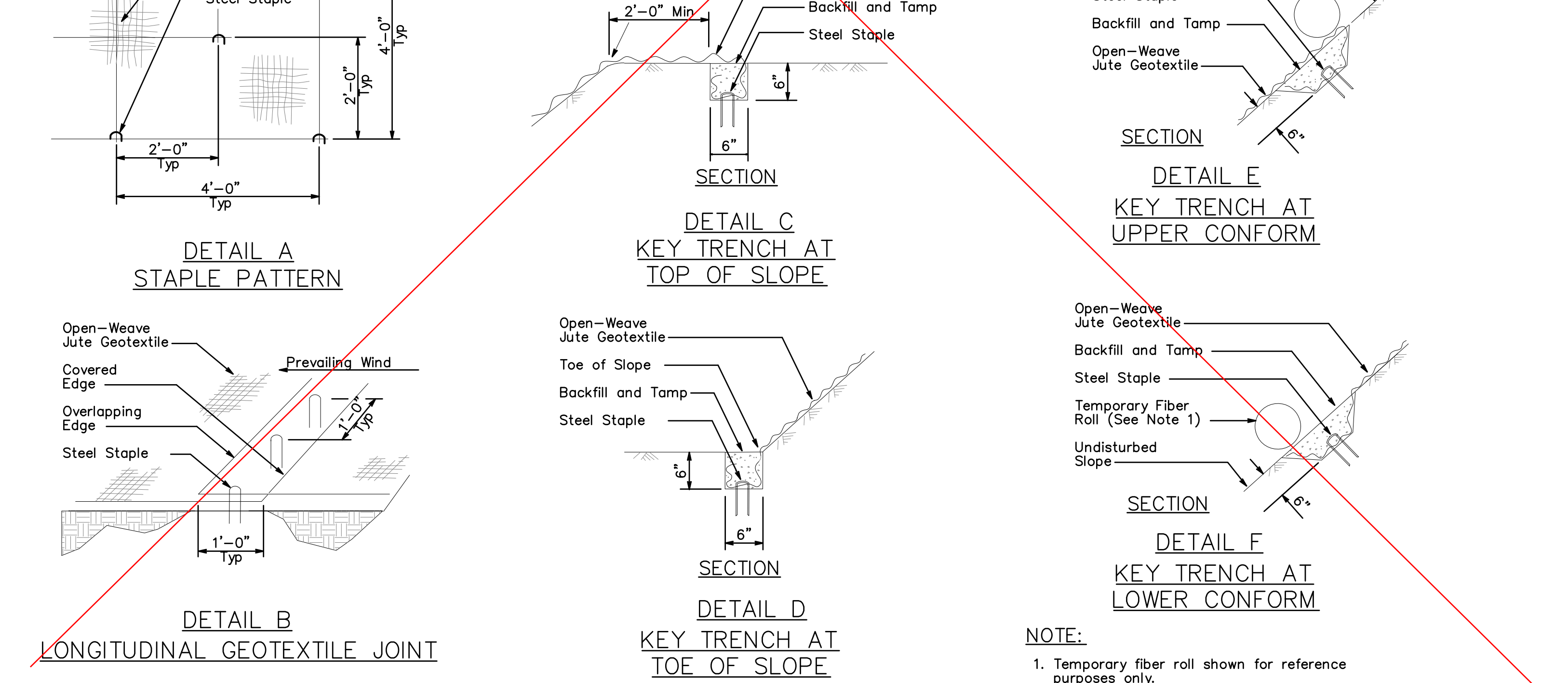

5 TEMPORARY FIBER ROLL
N.T.S. REF:

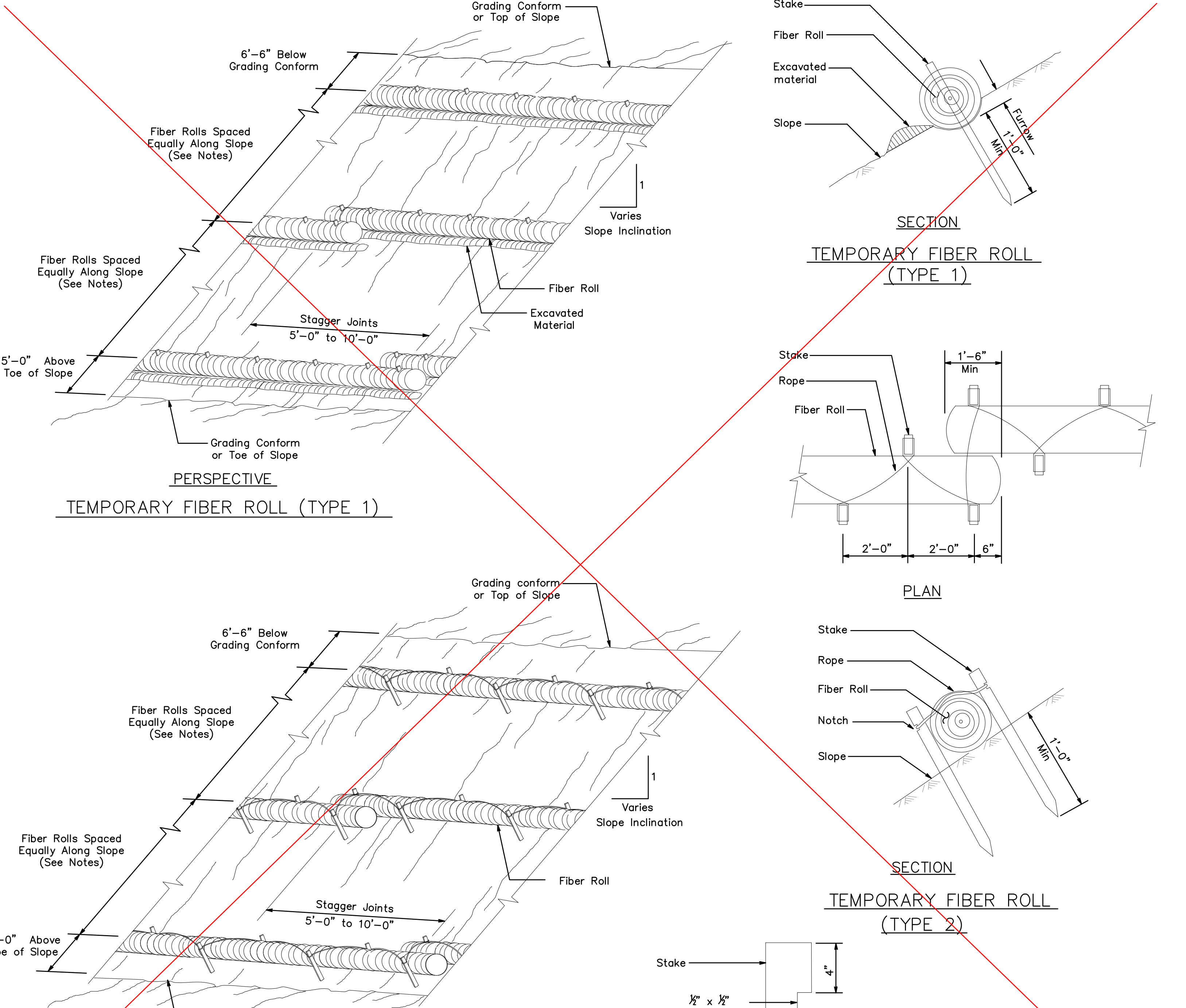

5 TEMPORARY FIBER ROLL
N.T.S. REF:

UC Merced Lazy K Restoration

Lazy K Restoration

NOTES:

1. Temporary fiber roll spacing varies depending upon slope inclination.
2. Installations shown in the perspectives are for slope inclination of 10:1 and steeper.

**SECTION 01 11 00
SUMMARY OF WORK**

PART 1 - GENERAL

1.1 WORK REQUIRED BY CONTRACT DOCUMENTS

- A. Scope of Work Overview: The work to be done includes all labor, tools and equipment necessary to furnish and install all materials and equipment shown on the drawings and described herein and to perform excavation of small mammal burrows in designated areas as directed by Designated Biologist and to perform grading work to develop vernal pools per the Contract Documents. This includes, but is not limited to, the following:
1. Pull and pay for final grading permit for Madera County for the project. Cost of the permit will be reimbursed to the General Contractor.
 2. Provide SWPPP erosion control measures as identified in the Contract Documents.
 3. Prior to commencement of clearing the project site, a Biological clearing survey is to be completed to determine areas of special concern and Environmentally Sensitive Areas.
 4. Based on this Biological clearing survey, General Contractor is to excavate small mammal burrows in identified areas as directed by Designated Biologist. General Contractor may assume for bidding purposes that there are 450 mammal burrow complexes with an average of 5-6 burrow entrances per complex (roughly 2,500 total burrows) within the project area. This is an average density of roughly 7 burrow complexes per acre.
 5. General Contractor shall provide a unit price for one backhoe and operator for a duration of 20 working days to be utilized at the discretion of the University to supplement the excavation of small mammal burrows once the bidding quantities have been completed (item 4 above).
 6. General Contractor shall coordinate all grading work with the Designated Biologist throughout the project as necessary to maintain the intent of the regulations of this Work. All grading work shall be coordinated through the use of GIS data of the restoration design that will be loaded onto General Contractor's tractor-mounted GPS units to guide construction, as well as identify and mark equipment travel corridors and staging areas.
 7. When an area is cleared by the Designated Biologist and upon direction of the University Representative, the areas to be prepared shall be rough graded, filled and finish graded per plans and specifications.
 8. All excess or unsuitable soils shall be stockpiled on Project Site at a location designated by the University Representative.

9. Any native backfill material that may be required shall be taken from on-site areas as determined by the Designated Biologist.
 10. General Contractor to provide staking of work limits.
 11. Reseeding of Upland Area as identified in the Contract Documents and disturbed areas as determined by the Designated Biologist. Topsoil to be redistribution from grading efforts on project. Augmented seed mix is as identified in the Technical Narrative.
 12. General Contractor is to perform this work under the direct supervision of the Designated Biologist; no work shall be performed if the Designated Biologist is not present. General Contractor may assume for bidding purposes that a minimum of 2 Designated Biologists will be present on site during construction activities.
 13. General Contractor's work will be observed, but not directed by, Native American Monitor(s). Subject to the Contract Documents, Native American Monitor has the right to stop work if there is an apparent Native American archeological finding.
- B. Scope of Work – Exclusions:
1. Testing and inspection (by University).
 2. SWPPP Inspection (by University).
 3. Biological (Terrestrial and Botanical) Surveys (by Designated Biologist).
 4. Handling and relocation of any discovered sensitive species (by Designated Biologist).

1.2 PROJECT PHASING

- A. Work Phases: Listed in chronological order.
1. Small Mammal Burrow Excavation
 2. Grading
 - a. Must be completed by start of rainy season, 10/15/2015.
 3. Reseeding
 - a. Must be completed before the end of 2015.

1.3 Scheduling

- A. General Contractor is to develop Contract Schedules as described in Section 01 31 45. General Contractor will be required to perform its work in accordance with a Detailed Project Schedule approved by the University's Representative to be developed, updated, and maintained by the General Contractor after award of the Contract. General Contractor will be required to provide specified scheduling information

necessary for the development, updating, and maintenance of the Detailed Project Schedule such that the schedule meets all occupancy and completion milestones.

1.4 FINAL COMPLETION

- A. Final Completion shall be applicable to the entire work as required by Article 4 of the Contract Agreement.

PART 2 - PRODUCTS (NOT USED)

PART 3 - EXECUTION (NOT USED)

END OF SECTION 01 11 00

SECTION 01110 1.10
NATURAL RESOURCE AVOIDANCE AND MINUMIZATION MEASURES

PART 1 - GENERAL

1.1 WORK REQUIRED BY CONTRACT DOCUMENTS

A. Contractor shall comply with the following permits and plan:

1. Clean Water Act, Section 404, Department of the Army Permit Number-1999-00203.
2. California Endangered Species Act, California Department of Fish and Game Incidental Take Permit Number 2081-2009-010-04.
3. Final Construction Mitigation Plan for Biological Resources for the University of California, Merced Project, ICF Jones and Stokes, November 2009.

B. Training Program

1. Prior to working on the Project site, all construction personnel shall attend a training program provided by the University. The training will include at minimum, a description of the species at risk and their habitat, the importance of the species and their habitat, the general measures being implemented to conserve the sensitive areas/species, and the boundaries within which the project may be accomplished.
2. The training shall be conducted in English and Spanish and shall consist of a presentation and the distribution of appropriate literature. The Contractor shall ensure that all Contractor, sub-contractor and Contractor supplier personnel attend a training session before they start working at the Project site.
3. The Contractor shall be responsible for ensuring that all personnel working on the Project site shall apply their signature to a declaration stating that they have attended and understand the natural resource training they have received. Such declaration shall be made before commencing activities upon the site. These declarations shall be kept by the University's Security's Contractor on the Project site and shall immediately be available to the University's Representative upon request.

C. Natural Resource Best Management Practices

The Contractor shall ensure that the following site regulations, which will be identified in the Training program, are adhered to:

1. All food related items shall be properly disposed of, and signs indicating that the feeding of wildlife is prohibited shall be placed at the Project site.
2. Vehicle traffic shall occur primarily between dawn and dusk, and shall be limited to 20 mph to reduce the potential for wildlife road mortality.
3. For any trench or pit that exceeds 2 feet depth, Contractor will provide an earthen escape ramp of no more than 3:1 slope every 200 feet. Before holes or trenches are filled, the Designated Biologist shall thoroughly inspect them for trapped animals. If the Contractor discovers that Covered Species have become trapped, Contractor shall cease all work in the vicinity and notify the Designated Biologist immediately. Contract and the Designated Biologist shall allow the Covered Species to escape unimpeded if possible.

4. Pipes, culverts, etc. greater than three inches in diameter shall be stored in such a way as to prohibit foxes or other species from using these areas as temporary refuge. In addition, these structures shall be thoroughly inspected each morning for Covered Species. If during inspection a Covered Species is discovered inside, Contractor shall notify Designated Biologist and allow the animal to safely escape that section of pipe before moving, utilizing, burying or capping the pipe.

5. No firearms shall be allowed on this Property.

6. No pets shall be permitted on this Property.

7. The use of pesticides on the Project site by the Contractor, including but not limited to rodenticides, insecticides and herbicides, is prohibited unless prior written approval of the University's Representative is obtained.

8. Construction vehicles shall be limited to a maximum speed of 20 mph in the vicinity of breeding ponds of California tiger salamander during the salamander movement period. The location of the breeding ponds and dates of the movement period shall be identified by the University's Representative.

~~9. California tiger salamander exclusion fencing shall be established around the construction footprint and maintained throughout all construction activities. The University's Representative has estimated that approximately 15,000 linear feet of exclusion fencing will be required along the northern and eastern boundary of the project site. The Contractor shall use silt fencing, which consists of a fine (less than 0.4 inches) mesh equipped with one way exit ramps approximately 150 feet apart to avoid entrapment of amphibians inside the fence. Fencing shall be buried to a depth of six (6) inches and will be a minimum of 3.3 feet tall following installation.~~

10. Contractor shall monitor the National Weather Service (NWS) 72-hour forecast for the Project area. If a 70 percent or greater chance of rainfall is predicted within 72 hours of Project activity, all activities in areas within 1.3 miles of potential or known CTS breeding sites shall cease until no further rain is forecast. If work must continue when rain is forecast, a Designated Biologist, shall survey the Project site before construction begins EACH day rain is forecast. If a Designated Monitor is used to conduct surveys, a Designated Biologist must still be available to capture and relocate any CTS that are discovered during the surveys. If rain exceeds ¼ inch during a 24 hour period, work shall cease until no further rain is forecast. This restriction is not applicable for areas within 1.3 miles of potential or known CTS breeding sites once they have been encircled with salamander exclusion fencing. However, even after salamander exclusion fencing is installed, this condition would still apply to construction related traffic moving through areas within 1.3 miles of potential or known CTS breeding sites but outside of the salamander exclusion fencing (e.g., on roads).

11. All night work in areas within 1.3 miles of potential or known CTS breeding sites shall be strictly prohibited when a 70 percent or greater chance of rainfall is predicted within 72 hours of Project activity, until no further rain is forecast. This restriction is not applicable for areas within 1.3 miles of potential or known CTS breeding sites once they have been encircled with salamander exclusion fencing as per ITP condition 8.6. However, even after salamander exclusion fencing is installed, this condition would still apply to construction related traffic moving through areas within 1.3 miles of potential or known CTS breeding sites but outside of the salamander exclusion fencing (e.g., on roads).

12. The Designated Biologist shall identify any areas containing burrowing owls. The Contractor shall establish "Sensitive Areas" around the occupied owl nests identified by the University's Representative. The Sensitive Areas shall not be disturbed by the Contractor. The Sensitive Areas shall extend to a distance of 160 feet from each occupied burrow during the non-breeding season of 1st September through 31 January. The sensitive Areas shall extend to a distance of 250 feet from each occupied burrow during the breeding season of 1st February through 31st August. The Contractor shall erect a temporary fence around occupied burrows. The Designated Biologist shall identify the location of active raptor nests adjacent to the Project site. Should an active Swanson's Hawk nest be located within 0.5 miles of the Project site, or an active nest of another raptor species be identified within 500 feet of active construction, the Designated Biologist will, in consultation with the California Department of Fish & Game, determine the actions necessary to protect the nest site. Such actions may include avoiding construction within a distance from the nest determined by the Designated Biologist for a period determined by the Designated Biologist.

13. If active nests of other special-status birds and other migratory birds and raptors are located within 500 feet of the work area, a buffer zone will be established based on the individual responses of the occupying birds, as assessed by a Designated Biologist and in coordination with the California Department of Fish & Game, and construction can proceed. If active nests are located within the work area, construction will be delayed until the young have fledged. The protection measures will be developed in coordination with the California Department of Fish & Game. If western pond turtles are observed within 100 feet of the work area, they will be allowed to move out of the way on their own. If active nests are found they will be fenced with an appropriate buffer and avoided until the young have hatched and are able to move out of the work area on their own.

14. Contractor shall inspect for Covered Species under vehicles and equipment before the vehicles and equipment are moved. If a Covered Species is present, the Contractor shall notify the Designated Biologist and wait for the Covered Species to move unimpeded to a safe location. Alternatively, the Designated Biologist shall move the Covered Species out of harm's way outside of the Project Area and in compliance with the approved relocation plan, if applicable.

15. If an injured Covered Species is discovered at any time, the Contractor is to notify the Designated Biologist immediately.

16. If California Tiger Salamander is found by any person in Project Area before or during work, the Contractor shall immediately stop all work that could potentially harm the CTS until Designated Biologist can relocate CTS.

17. To ensure compliance with the Conditions of ITP, Designated Biologist shall have authority to immediately stop any activity that is not in compliance with the ITP, and/or any order any reasonable measures to avoid the unauthorized take of an individual of the Covered Species, or a species not covered by the ITP.

END OF 01110.10-NATURAL RESOURCES AVOIDANCE & MINIMIZATION MEASURES

**SECTION 01 21 00
ALLOWANCES**

PART 1 - GENERAL

1.1 ALLOWANCES REQUIREMENTS

- A. Included in the Contract Sum are all Allowances stated below. Items covered by Allowances shall be supplied for such amounts and by such persons or firms as University's Representative may direct.
- B. The following shall apply, unless otherwise provided in the Contract Documents:
 - 1. Allowances shall cover the cost to Contractor of materials and equipment delivered at the Project site and all required taxes, less applicable trade discounts.
 - 2. Contractor's costs required for storage on and off the Project site, security, loading and unloading, handling at the Project site, labor, installation costs, overhead, profit, and other expenses contemplated for stated Allowance amounts shall be included in the Contract Sum and not in the Allowances.
 - 3. Unless otherwise provided herein, whenever costs are more than or less than Allowances, the Contract Sum shall be adjusted by Change Order based on (1) the difference between actual costs and the Allowances and (2) changes in Contractor's costs.
 - 4. At any time during the course of the Contract, the University's Representative may elect to delete any or all allowances via Change Order for full amount listed below.

1.2 DESCRIPTION OF ALLOWANCES

- 1. The following allowance shall be included in the LUMP SUM BASE BID:
 - a) ALLOWANCE No. 1 - Small Mammal Burrow Excavation:
Include **\$100,000** for small mammal burrow excavation work as described in Section 01 11 00, subsection 1.1.A.3.

PART 2 - PRODUCTS (NOT USED)

PART 3 - EXECUTION (NOT USED)

END OF SECTION 01 21 00

**SECTION 01 22 00
UNIT PRICES**

PART 1 - GENERAL

1.1 DESCRIPTION

- A. Unit Price quotations shall be inserted in the appropriate spaces in the Bid Form for each Unit Price item of Work described herein.
- B. Unit Prices stated in the Agreement shall be used to compute adjustments of the Contract Sum for approved Unit Price items of Work. Such adjustments shall be made by Change Order (Exhibit 9).
- C. Unit Prices shall include all labor, materials, tools, and equipment; all other direct and indirect costs necessary to complete the item of Work and to coordinate the Unit Price Work with adjacent Work; and shall include all overhead and profit. General Contractor shall accept compensation computed in accordance with the Unit Prices for work installed in place as full compensation for furnishing such Work.
- D. Compensation will be paid for those items of Work described in below, Unit Prices.

1.2 SPECIFIED WORK

- A. Applicable Sections of the Specifications describe the materials and methods required under the various Unit Price items of Work.

1.3 UNIT PRICES

- A. List of Unit Price Items and Descriptions

Unit Price No.	Description	Estimated Units
1	Small Mammal Burrow Excavation – 1 Backhoe with Operator for an 8 hour day	20 Work Days

1.4 ADVANCED COORDINATION

- A. Immediately notify University's Representative when conditions require the use of Unit Price items of Work.
- B. The applicability of, measurement methods for, documentation of, and the final adjustment of the Contract Sum for Unit Price items of Work shall be determined by the University's Representative.

- C. After performing Unit Price items of Work as directed by University's Representative, General Contractor shall take necessary measurements in the presence of University's Representative and shall submit calculations of quantities to University's Representative for approval. General Contractor shall notify University's Representative 1 day in advance of taking measurements.

PART 2 - PRODUCTS (NOT USED)

PART 3 - EXECUTION (NOT USED)

END OF SECTION 01 22 00

SECTION 01 25 00
PRODUCT OPTIONS AND SUBSTITUTIONS

AS IT APPLIES

PART 1 - GENERAL

- 1.1 GENERAL PROVISIONS REGARDING SPECIFICATION OF PRODUCTS, MATERIAL OR EQUIPMENT BY BRAND OR TRADE NAME.
- A. Products, material or equipment specified by both brand or trade name and model number are approved for use, provided the Contractor complies with all Contract requirements. Specification of a product, material or equipment by brand or trade name and model number is not a representation or warranty that the product, material or equipment can be used without modification, to meet the requirements of the plans and specifications; Contractor shall, at its sole cost, modify such products, material, or equipment so that they comply with all requirements of the plans and specifications.
 - B. The first-named product, material or equipment specified by brand or trade name and model number is the basis for the Project design and the use of any item other than the first-named one may require modifications of that design. If Contractor uses any product, material or equipment other than the first-named one, Contractor shall, at its sole cost:
 - 1. Make all revisions and modifications to the design and construction of the Work necessitated by the use the product, material or equipment.
 - 2. Be responsible for all costs of any changes resulting from the use of the product, material or equipment including without limitation, costs or changes which affect other parts of the Work, the work of Separate Contractors, or any other property or operations of the University.
 - C. When a product, material or equipment specified by brand or trade name is followed by the words "or equal," a substitution may be permitted if the substitution is equal to or superior to the first-named product, material or equipment in quality, utility and appearance and if the substitution complies with all other requirements of the plans and specifications.
 - D. A product, material or equipment specified by brand or trade name followed by the words "or equal, no known equal," signifies that University does not have sufficient knowledge to specify a product, material or equipment, other than the one specified by brand or trade name, that is suitable for use on the Project. The use of the words "no known equal" is not intended to discourage substitution requests in accordance with the requirements specified herein.
 - E. When catalog numbers and specific brands or trade names not followed by the designation "or equal" are used in conjunction with a product, material or equipment required by the specifications, substitutions will not be allowed and the named product, material or equipment must be used.
 - F. Specification of a product, material or equipment by brand or trade name and model number is not a representation or warranty that the product, material or equipment is

available; Contractor should confirm, prior to submitting its Bid, the availability of any product, material or equipment specified by brand or trade name and model number.

- G. **COMPLETE AND ACCEPTABLE SUBSTITUTION SUBMITTALS SHALL BE DELIVERED TO THE UNIVERSITY'S REPRESENTATIVE NO LATER THAN 35 DAYS FROM THE NOTICE TO PROCEED. SUBMITTALS MAY BE REQUIRED SOONER THAN 35 DAYS IF THE NOTICE TO PROCEED WAS DELAYED BY THE CONTRACTOR OR IF REQUIRED BY EARLY ACTIVITIES INDICATED ON THE PRELIMINARY MASTER PROJECT SCHEDULE.**

1.2 **SPECIAL REQUIREMENTS FOR PRODUCTS, MATERIAL OR EQUIPMENT, OTHER THAN THE FIRST-NAMED PRODUCT, MATERIAL OR EQUIPMENT, SPECIFIED BY BOTH BRAND OR TRADE NAME AND MODEL NUMBER.**

- A. In addition to complying with all other submittal requirements of the Contract, submit within 5 days after the date of commencement specified in the Notice to Proceed, for review and approval by the University's Representative, Contractor prepared specifications and drawings, including design and engineering calculations, prepared by an appropriate licensed professional, depicting all revisions and modifications to the design and construction of the Work necessitated by the use of the product, material or equipment. If no revisions or modifications are necessary, submit within 5 days after the date of commencement specified in the Notice to Proceed, a written representation that no revisions or modifications to the design or construction of the Work are necessitated by the use of the product, material or equipment. Contractor shall utilize the first-named product, material or equipment if Contractor fails to make the appropriate required submittal pursuant to this paragraph within the 5-day period.
- B. A product, material or equipment, other than the first-named product, material or equipment, specified by both brand or trade name and model number may be used if no revisions or modifications to the design or construction of the Work are necessitated by the use of the product, material or equipment. If such revisions or modifications are necessary, the product, material or equipment may be used only if the revisions or modifications are approved in writing by the University's Representative. Contractor has the burden of demonstrating, through the procedures specified herein, that any such revisions or modifications will not be detrimental to the quality, utility or appearance of the Project or any portion of the Project. The University's Representative may refuse to approve any such proposed revisions or modifications where, in the reasonable opinion of the University's Representative, Contractor has failed to demonstrate, through the procedures specified herein, that the revisions or modifications are not detrimental to the quality, utility or appearance of the Project or any portion of the Project.

1.3 **SPECIAL REQUIREMENTS FOR SUBSTITUTIONS.**

- A. In addition to complying with all other submittal requirements of the Contract, submit written data demonstrating that the proposed substitution is equal to or superior to the first-named product, material or equipment in quality, utility and appearance and otherwise complies with all requirements of the plans and specifications, including:

1. Complete technical data including drawings, performance specifications, samples, and test reports of the article proposed for substitution.
 2. Statement by Contractor that the proposed substitution is in full compliance with the requirements of the Contract Documents and Applicable Code Requirements.
 3. List of Subcontractors, if any, that may be affected by the substitution.
 4. Contractor prepared specifications and drawings, including design and engineering calculations, prepared by an appropriately licensed professional, depicting all revisions and modifications to the design and construction of the Work necessitated by the use of the substitution. If no revisions or modifications are necessary, submit a written representation that no revisions or modifications to the design or construction of the Work are necessitated by the use of the product, material or equipment.
- B. At the request of and within the timeframes specified by the University's Representative:
1. Submit samples as deemed necessary by the University's Representative to evaluate the proposed substitution.
 2. Submit proposed substitution to tests deemed necessary by the University's Representative to evaluate the proposed substitution. Such tests shall be made by an independent Testing Laboratory and at the sole expense of Contractor, after review and approval of the test procedures by University's Representative. If re-testing is deemed necessary by the University's Representative to evaluate the proposed substitution, such re-testing shall be made by an independent Testing Laboratory at the sole expense of the General Contractor.
 3. Provide any additional information deemed necessary by the University's Representative to evaluate the proposed substitution.
- C. If University's Representative, in reviewing a proposed substitution, requires revisions or corrections to be made to previously accepted shop drawings and supplemental supporting data to be resubmitted, Contractor shall do so within the time period specified by the University's Representative. A proposed substitution may be rejected if Contractor fails to submit such revisions, corrections, or supplemental supporting data within the specified time period.
- D. Except for products, material or equipment designated in the Bidding Documents for evaluation of substitutions prior to award, requests for substitution, including the data required by Paragraph 1.3.A, must be submitted to the University's Representative not later than 35 days after the date of commencement specified in the Notice to Proceed. No requests for substitutions of products, material or equipment subject to the 35-day deadline shall be considered unless the request and supporting data is submitted on or before the deadline, except those deemed, in University's Representative's sole opinion, to be necessary because (i) previously specified or approved manufactured products, material or equipment are no longer manufactured, (ii) of University initiated change orders, or (iii) it is in the best interest of University to accept such substitution.
- E. If a product, material or equipment is designated in the Bidding Documents for evaluation of substitutions prior to award, then a request for substitution of the product, material or equipment, including the data required by Paragraph 1.3.A, must be submitted by the deadline specified in the Bidding Documents. Because of time constraints, only one submittal will be allowed for each such substitution request. Requests for

substitutions of products, material or equipment designated for evaluation prior to award may not be made after the deadline specified in the Bidding Documents, and such requests shall not be considered unless the request and supporting data is submitted on or before the deadline specified in the Bidding Documents. Notwithstanding the foregoing, the University may consider, after award of the Contract, requests for substitution of a product, material or equipment designated for evaluation prior to award where, in University's Representative's sole opinion, a substitution is necessary because (i) previously specified or approved manufactured products, material or equipment are no longer manufactured, (ii) of University initiated change orders, or (iii) it is in the best interest of University to accept such substitution.

- F. In reviewing the supporting data submitted for substitutions, University's Representative will use, for purposes of comparison, all the characteristics of the specified material or equipment as they appear in the manufacturer's published data even though all the characteristics may not have been particularly mentioned in the Specifications. If more than 2 submissions of supporting data are required, the cost of reviewing the additional supporting data shall be at Contractor's expense.
- G. Contractor has the burden of demonstrating, through the procedures specified herein, that its proposed substitution is equal to or superior to the first-named product, material or equipment in quality, utility and appearance and complies with all other requirements of the plans and specifications. If revisions or modifications to the design or construction of the work are necessitated by the use of the substitution, Contractor also has the burden of demonstrating, through the procedures specified herein, that the use of the substitution will not be detrimental to the quality, utility or appearance of the Project or any portion of the Project.
- H. The University's Representative may refuse to approve any requested substitution where, in the reasonable opinion of the University's Representative, Contractor has failed to demonstrate, through the procedures specified herein, that the proposed substitution is equal to, or superior to, the first-named product, material or equipment, in quality, utility and appearance and that the proposed substitution complies with all other requirements of the plans and specifications.
- I. University's Representative may reject any substitution not proposed in the manner and within the time limits prescribed herein.
- J. Substitutions are not allowed unless approved in writing by the University's Representative. Any such approval shall not relieve Contractor from the requirements of the Contract Documents.
- K. The 35-day and 5-day submittal periods do not excuse Contractor from completing the Work within the Contract Time or excuse Contractor from paying liquidated damages if Final Completion is delayed.
- L. If revisions or modifications to the design or construction of the Work are necessitated by the use of a substitution, the substitution may be used only if the revisions and modifications are approved in writing by the University's Representative. The University's Representative may refuse to approve any such proposed revisions or modifications where, in the reasonable opinion of the University's Representative,

Contractor has failed to demonstrate, through the procedures specified herein, that the revisions or modifications are not detrimental to the quality, utility and appearance of the Project or any portion of the Project.

- M. If a substitution request is finally rejected by the University Representative, Contractor shall furnish and install:
1. the first-named product, material, or equipment; or
 2. a product, material, or equipment, other than the first-named product, material or equipment, specified by both brand or trade name and model number, provided Contractor complies with the submittal requirements (including deadlines) of subsection 1.2 above.

PART 2 – PRODUCTS (NOT USED)

PART 3 – EXECUTION (NOT USED)

END OF SECTION 01 25 00

SECTION 01 26 13
REQUESTS FOR INFORMATION

PART 1 - GENERAL

1.1 SUMMARY

- A. This section contains the procedures to be followed by the Contractor for submitting requests for clarification or additional information.

1.2 PROCEDURES

- A. Notification by the Contractor:
1. Submit all requests for clarification and/or additional information in writing to the University's Representative using the Request for Information (RFI) form (Exhibit 17).
 2. RFI's not completely and correctly filled out by the Contractor will not be answered. Impacts to the Project arising from the Contractor's failure to properly submit RFI's are the Contractor's sole responsibility.
 3. Number RFI's sequentially. Submit a new RFI for each new question. Follow RFI number with sequential alphabetical suffix as necessary for each resubmission. For example, the first RFI shall be '001.' The second RFI shall be '002.' The first resubmittal of RFI 002 shall be '002.001.'
- B. Limit each RFI to one subject and one subject only. RFI's addressing more than one subject will not be answered.
- C. Submit RFI's if one of the following conditions occurs:
1. Contractor discovers an unforeseen condition or circumstance that is not described in the Contract Documents.
 2. Contractor discovers an apparent conflict or discrepancy between portions of the Contract Documents that appears to be inconsistent or is not reasonably inferred from the intent of the Contract Documents.
 3. Contractor discovers what appears to be an omission from the Contract Documents that cannot be reasonably inferred from the intent of the Contract Documents.
- D. Non Compliant RFI's
1. RFI's will not be recognized or accepted if, in the opinion of the University's Representative, one of the following conditions exist:
 - a. The Contractor submits the RFI as a request for substitution.
 - b. The Contractor submits the RFI as a submittal.
 - c. The Contractor submits the RFI under the pretense of a Contract Documents discrepancy or omission without thorough review of the Documents.
 - d. The Contractor submits the RFI in manner that suggest that specific portions of the Contract Documents are assumed to be excluded or by taking an isolated portion of the Contract Documents in part rather than whole.
 - e. The Contractor submits an RFI in an untimely manner without proper coordination and scheduling of Work or related trades.

2. If over 10% of the RFI's received from the Contractor are found to fall into these categories, the Contractor will be back charged the cost to the University of the additional effort required to respond to these inappropriate questions. Such back charges may include expenses incurred by the University's Design Professional as determined by the University's Representative. Said back charges will be deducted from the Contract Sum.

PART 2 - PRODUCTS (NOT USED)

PART 3 - EXECUTION

3.1 Requests for Information

- A. Contractor shall ask for any clarification or request for information immediately upon discovery. Contractor shall submit RFI's in a reasonable time frame so as not to affect the project schedule while allowing the full response time described below. RFI's shall include:
 1. Specification Section or Drawing Number and Detail impacted.
 2. Address impacts to schedule and cost.
 3. Suggest possible solutions to fit field conditions, if appropriate.
- B. Response Time:
 1. The University's Representative, whose decision will be final and conclusive, shall resolve such questions and issue instructions to the Contractor within a reasonable time frame. In most cases, RFI's will receive a response within **7 calendar days**. In some cases, this time frame may need to be lengthened for complex issues, or shortened for emergency situations, as mutually agreed in writing between the University's Representative and the Contractor.
 2. Should the Contractor proceed with the Work affected before receipt of a response from the University's Representative, any portion of the Work which is not done in accordance with the University's Representative's interpretations, clarifications, instructions, or decisions is subject to removal or replacement and the Contractor shall be responsible for all resultant losses.
- C. Failure to Agree: In the event of failure to agree as to the scope of the Contract requirements, the Contractor shall follow procedures set forth in the General Conditions.

END OF SECTION 01 26 13

SECTION 01 31 00
PROJECT COORDINATION

PART 1 - GENERAL

1.1 COORDINATION REQUIREMENTS

- A. General Contractor shall coordinate the Work and shall not delegate responsibility for coordination to any Subcontractor.
1. General Contractor shall anticipate the interrelationship of all Subcontractors and their relationship with the Work.
 2. General Contractor shall resolve differences or disputes between Subcontractors concerning coordination, interference, or extent of the Work between Sections.
 3. General Contractor shall coordinate the Work of Subcontractors so that portions of the Work are performed in a manner that minimizes interference with the progress of the Work.
 4. General Contractor shall not obstruct spaces and installations that are required to be clear by Applicable Code Requirements.
 5. General Contractor shall not cover any piping, wiring, ducts, or other installations until they have been inspected and approved and required certificates of inspection issued.
 6. General Contractor shall remove and replace all Work that does not comply with the Contract Documents. Repair or replace any other Work or property damaged by these operations with no adjustment of Contract Sum.
 7. General Contractor shall coordinate all portions of the Work requiring careful coordination in order to fit in space available. Before commencing such portions of the Work, prepare supplementary drawings for review by the University's Representative.
 8. General Contractor shall ensure that anchorage, blocking, joining, and other detailing are provided as required.
- B. Should unavoidable conflicts be encountered during the preparation or review of the Shop Drawings, or during construction, they shall be promptly brought to the attention of the University's Representative, in writing, for resolution.
- C. Where the Drawings are diagrammatic, showing only the general arrangement of the systems, General Contractor shall have responsibility for the fitting of materials and equipment to other parts of the equipment and structure, and to make adjustments as necessary or required to resolve space problems, preserve service room, and avoid architectural and structural elements and the Work of other trades. General Contractor may be required to identify certain areas to relocate installations within the spaces depicted on the Drawings, e.g., ductwork may be shifted within the space shown to accommodate other systems. Such functional relocations shall not be deemed a change to the requirements of the Contract. In the event a major re-routing of a system appears necessary, General Contractor shall prepare and submit for approval, Shop Drawings of the proposed rearrangement.
1. Because of the diagrammatic nature and small scale of the Drawings, all necessary offsets, adjustments, and transitions required for the complete installation are not shown. General

Contractor shall carefully investigate the structural and finish conditions affecting all the Work and shall arrange such Work accordingly, furnishing such fittings, equipment, valves, accessories, etc., as may be required to meet such conditions, at no additional cost to the University.

PART 2 - PRODUCTS (NOT USED)

PART 3 - EXECUTION (NOT USED)

END OF SECTION 01 31 00

**SECTION 01 31 19
PROJECT MEETINGS**

PART 1 - GENERAL

1.1 CONTRACTOR PRECONSTRUCTION CONFERENCE(S)

- A. Prior to commencement of Work, a preconstruction conference will be conducted by the University's Representative to discuss procedures that are to be followed during performance of the Work.
- B. Location: As designated by University's Representative.
- C. Attending shall be:
 - 1. University's Representative.
 - 2. Contractor's Project Manager
 - 3. Contractor's Project Site Superintendent.
 - 4. Subcontractors, as appropriate or as requested by the University's Representative.
 - 5. Others as appropriate or as requested by the University's Representative.

1.2 BILLING MEETINGS

- A. Monthly billing meeting shall be conducted by University's Representative each month prior to submittal of the Application For Payment (Exhibit 4).
- B. Location: As designated by University's Representative.
- C. Attending shall be:
 - 1. University's Representative.
 - 2. University's Inspection Team.
 - 3. Others as appropriate or as requested by the University's Representative.

1.3 OAC (OWNER, ARCHITECT, CONSTRUCTION MANAGER) PROGRESS MEETINGS

- A. Weekly progress meetings will be held to discuss and resolve field problems. The University's Representative shall conduct these meetings.
- B. Location: At University's Representative job trailer and via conference call.
- C. Attending shall be:
 - 1. University's Representative.
 - 2. University's Consultants (optional)
 - 3. University's Design Professional and Design Professional's Consultants as appropriate.
 - 4. Others as appropriate or as requested by the University's Representative.

1.4 PREPATORY MEETINGS AND PRE-INSTALLATION CONFERENCES

- A. The University's Representative will conduct a pre-installation conference at the site before each construction activity that requires coordination with other construction or when required in technical Specification Section.
- B. Attendance will be required of parties directly affecting, or affected by, or involved in the installation and its coordination or integration with other materials and installations that

have preceded or will follow the particular item of work or activity under consideration. Parties attending the conference shall be qualified and authorized to act on behalf of entity each represents.

- C. Conference Schedule: Schedule conference to assure a sufficient amount of time prior to the scheduled work or activity under consideration so that any concerns, problems or disagreements can be resolved without delaying the Project. Notify the University's Representative 7 days in advance of meeting date.
- D. The University's Representative will make physical arrangements for conferences, prepare agenda, preside at conferences, record minutes, and distribute copies within two days after conference to the University's Representative, the Project Inspector, conference participants and those affected by the decisions made at the conference. The University's Representative will record in the minute's significant discussions and agreements and disagreements.
- E. Do not proceed with the work or activity if the conference cannot be successfully concluded. Initiate whatever actions are necessary to resolve impediments to performance of work and reconvene the conference at the earliest feasible date.

1.5 GUARANTEES, BONDS, WARRANTIES AND SERVICE/OPERATION AND MAINTENANCE CONTRACTS/DATA REVIEW MEETING

- A. Eleven months following the date of Substantial Completion, a meeting shall be conducted by the University's Representative for the purpose of reviewing the guarantees, bonds, and service and maintenance contracts for materials and equipment. The Contractor shall take action as appropriate to implement repair or replacement of defective items, and to extend service and maintenance contracts as required.
- B. Attending shall be:
 - 1. University's Representative.
 - 2. University's Consultants, as appropriate.
 - 3. University's Design Professional and Design Professional's Consultants as appropriate.
 - 4. Contractor superintendent(s) whom will be managing the project from on site.
 - 5. Subcontractors, as appropriate or as requested by the University's Representative.
 - 6. Others as appropriate or as requested by the University's Representative.

1.6 LEAN SCHEDULING AND PULL-PLANNING MEETINGS

- A. The University Representative will be utilizing the "Last Planner System" to develop and implement a phased schedule that supplements and supports the Master Schedule included within the bid documents.
 - 1. This will require time commitment from officers and supervisors of Contractor and all Subcontractors.
 - 2. Contractor will be required to provide their input and commitment to the final schedule.
 - 3. There will be a workshop held prior to the start of construction where the process will be explained in detail and the Master Project Schedule reviewed.

Periodically “pull planning” sessions will be held to refine and expand on the detail in the Master Project Schedule. These sessions will require the contractor’s superintendents and foreman to brainstorm and create detailed activities and resource requirements that support the Master Schedule.

B. Attending shall be:

1. University’s Representative.
2. University’s Consultants (optional).
3. University’s Design Professional and Design Professional’s Consultants as appropriate (optional)
4. Contractor superintendent(s) whom will be managing the project from on site.
5. Subcontractors, as appropriate or as requested by the University’s Representative.
6. Others as appropriate or as requested by the University’s Representative.

PART 2 - PRODUCTS (NOT USED)

PART 3 - EXECUTION (NOT USED)

END OF SECTION 01 31 19

**SECTION 01 31 42
CONTRACTOR SCHEDULES**

PART 1 - GENERAL

1. CONTRACTOR SCHEDULE

The Contractor is to utilize the “Last Planner System” to develop and implement a phased schedule that supplements and supports the Preliminary Master Project Schedule as defined in this section. This will require time commitment from officers and supervisors of the Contractor and all Subcontractors. The Contractor and all Subcontractors will be required to provide their input and commitment to the final schedule.

A. Pull Planning Sessions

1. There will be a workshop held prior to the start of construction where the process will be explained in detail and the Contractor’s Preliminary Master Project Schedule reviewed.
2. Periodically “pull planning” sessions will be held to refine and expand on the detail in the Preliminary Master Project Schedule.
3. These sessions will require the Contractor and Subcontractor’s superintendents and foreman to brainstorm and create detailed activities and resource requirements that support the Preliminary Master Project Schedule.
4. After the Contractor and all Subcontractors agree to each other’s input, all parties will commit to this updated schedule.

B. Submit

1. Six week look-ahead schedules will be reviewed and updated each week and will be the basis of a Weekly Work Plan (WWP).
2. The Contractor will be required to submit their WWP on a weekly basis prior to that week.

C. Form

1. The WWP will consist of a production plan in which quantity goals as well as weekly manpower requirements established consistent with meeting the overall project schedule.
2. Prepare the WWP in sufficient detail to demonstrate preliminary planning for the Work and to represent a practical plan to complete the Work within the Contract Time and in accordance with the Preliminary Master Project Schedule.

D. Activities

1. The WWP will consist of a production plan in which quantity goals as well as weekly manpower requirements established consistent with meeting the overall project schedule.
2. Identify all holidays, including University holidays, and non-working days on the WWP.

3. During the Pull Planning Sessions the Contractor and each Subcontractor will identify all Work activities in correct sequence for the completion of the Work. Work activities will include the following:
 - a. Major Contractor-furnished equipment, materials, and building elements, and scheduled activities requiring submittals or University's prior approval.
 - b. System test dates.
 - c. Scheduled overtime Work if required by Contract Documents.
 - d. Dates designated for working spaces, storage areas, access, and other facilities to be provided by University.
 - e. Dates orders and decisions from University on designated items are due.
 - f. Dates for delivery of University-furnished equipment.
 - g. Dates for University-furnished utilities.
 - h. Connection and relocation of existing utilities.
 - i. Connection to or penetrating existing structures.
 - j. Scheduled inspections as required by Codes, or as otherwise specified.

4. During the Pull Planning Sessions the Contractor and each Subcontractor will identify all Work activities that constitute the critical path.
 - a. Critical Work activities are defined as Work activities which, if delayed or extended, will delay the scheduled completion of one or more of the milestones specified in this Section or the scheduled completion of the Work, or both. All other Work activities are defined as non-critical Work activities and are considered to have float.

1.2 PRELIMINARY MASTER PROJECT SCHEDULE

- A. The Preliminary Master Project Schedule shall be utilized for monitoring progress of the Work and represent a practical plan to complete the Work within the Contract Time.

- B. The Preliminary Master Project Schedule will identify the following milestone events:
 1. Refer to the Preliminary Master Project Schedule shown in the Bidding Documents for milestone activities listed in Section 01 31 45 Contractor Schedules.

- C. The Preliminary Master Project Schedule will identify all holidays and non- working days.

- D. Updating.
 1. The Preliminary Master Project Schedule and WWP will be monitored and updated each week during the construction phase by the whole project team.
 2. Monitoring and evaluation will cover not only future activities; but completed activities will be evaluated from a "lesson learned" perspective in order to improve on future planning activities.
 3. Project team members will be held accountable for meeting these goals.
 4. No Applications For Payment will be processed nor shall any progress payments become due until updated information is accepted by University's Representative.

1.3 TIME CONTROL

- A. Set up control procedures so that approved schedules are adhered to. Contractor's responsibility is to properly notify University's Representative of anticipated and actual time delays (refer to General Conditions).

PART 2 - PRODUCTS (NOT USED)

PART 3 - EXECUTION (NOT USED)

END OF SECTION 01 31 42

**SECTION 01 31 45
CONTRACT SCHEDULES**

PART 1 - GENERAL

1.1 PRELIMINARY CONTRACT SCHEDULE

- A. Within the time stated in the Notice of Selection as Apparent Lowest Responsible Bidder, Contractor shall submit a preliminary work plan or schedule of proposed operations to the University's Representative for approval. This schedule shall acknowledge the full contract duration as well as significant known contract constraints. In preparation of the plan or schedule, the Contractor shall make due allowance for and include the following:
1. Preparation of equipment and material submittals for review.
 2. Procurement schedule.
 3. Construction and installation schedule.
 4. Major milestones.
- B. Form
1. Prepare the Preliminary Contract Schedule in sufficient detail to demonstrate preliminary planning for the Work and to represent a practical plan to complete the Work within the Contract Time.

1.2 PROJECT OR CONTRACT SCHEDULE

1. Within 30 working days of receipt of the Notice to Proceed, the Contractor shall submit a detailed project schedule. This Detailed Project Schedule shall incorporate the first 90 calendar days of contract Work as shown in the accepted Preliminary Contract Schedule.
2. Form:
 - a. The Detailed Contract Schedule shall be CPM (Critical Path Method), using PDM (Precedence Diagram Method) method of scheduling, with time scaled diagrams (plots) and tabular charts.
 - b. The Detailed Contract CPM Schedule when approved by the University, shall serve as the contract schedule for the project.
 - c. The Detailed Contract CPM Schedule duration shall conform to the full contract duration; and may include one or more float activities, to show full accounting of the Contract Time.
 - d. Prepare the Detailed Contract Schedule in sufficient detail to demonstrate serious planning for the Work and to represent a practical plan to complete the Work within the Contract Time.
 - e. Identify all holidays, UC Merced finals weeks and non-working days.
 - f. Critical Work activities are defined as Work activities that, if delayed or extended, will delay the scheduled completion of 1 or more of the milestones specified in this Section or the scheduled completion of the Work, or both. All other Work activities are defined as non-critical Work activities and are considered to have float.

- g. Float is defined as the time that a non-critical Work activity can be delayed or extended without delaying the scheduled completion of milestones specified in this Section or the scheduled completion of the Work, or both. Neither the General Contractor nor the University shall have an exclusive right to the use of float. The party using float shall document the effect on the updated Contract Schedule.

B. Content:

1. The Contract Schedule shall identify all Work activities in correct sequence for the completion of the Work. Work activities shall include the following:
 - a. Major Contractor-furnished equipment, materials, and building elements, and scheduled activities requiring submittals or University's Representative's prior approval.
 - 1) Show dates for the submission, review, and approval of each such submittal. Dates shall be shown for the procurement, fabrication, delivery, and installation of major equipment, materials, and building elements, and for scheduled activities designated by the University.
 - 2) A minimum of 14 days shall be allotted for University's Representative to review each submittal.
2. Date mobilization complete.
3. Scheduled overtime Work if required by Contract Documents.
4. Dates Contractor requests designated workspaces, storage area, access, and other facilities to be provided by the University.
5. Dates Contractor requests orders and decisions from the University on designated items.
6. Scheduled inspections as required by Codes, or as otherwise specified.
7. Milestone activities showing the point of substantial completion and final completion for each stage of the work, if designated in the Contract Documents, shall be included in The Preliminary Contract Schedule, Contract Schedule, and updates.

C. Presentation

1. Network Logic Diagrams
 - a. The Contract Schedule shall include all construction and demolition activities, procurement of equipment components and major off-site fabricated items, through the entire construction phase, including pre-commissioning and job close out. Completion or "Punch List" work shall be included in the Contract Time.
 - b. The Contract Schedule shall include a complete sequence of construction, in adequate detail for the planning and coordination of the Work. Unless approved by the University's Representative, there shall be no activities shown with durations in excess of 10 working days.
 - c. The Contract Schedule shall be depicted in the form of precedence diagramming method (PDM) and shall be segregated or divided into bands of activities to reflect the General Contractor's scheduling areas and/or phasing of all construction and procurement activities.

- d. The PDM Diagram may be divided into a number of separate pages with suitable notation relating to the interface points from one page to the other. Individual pages shall not exceed 30 by 42 inches.
 - e. Each activity shall be drawn so that the early start and early finish dates (or actual dates) are clearly indicated. The schedule plot also shall show the dates in tabular form.
 - f. Each activity shall reflect at least the following information:
 - 1) Description of the work.
 - 2) Activity duration (in work days).
 - 3) Activity number.
 - 4) Activity relationship and float.
 - g. All activities shall be shown, distinguishing critical
 - h. Critical path activities, non-critical activities and milestone activities.
 - i. For large schedules, a summary page shall be provided indicating the major milestones. The summary page shall include a legend that clearly identifies all symbols used within the CPM PDM Diagram. The summary page shall include an index listing all sheets within each sub-network.
 - j. Graphic schedules shall be accompanied by electronic data files of the network, showing all activities, durations, dependencies and constraints. The files shall be provided on 3.5 inch disk, Zip 100 disk, or CD-ROM, MS Windows format.
2. Tabular Computer Reports
- a. Accompanying the Construction Schedule, the Contractor shall submit various computer generated tabular reports as further described within this Section.
 - b. As requested by the University's Representative, the Contractor will be required to submit additional Schedule and Cost Reports.
- D. Computer System and Computer Generated Tabular Reports:
1. The computer system selected shall be based on PRIMAVERA/PRIMAVISION®, or equal.
 2. The computer software employed by the University's Representative will be capable of:
 - a. Numeric or Alpha/Numeric activity numbering.
 - b. Activity codings (to facilitate selecting groups or groupings of activities), with at least a 6-position alpha/numeric code.
 - c. Activity description field of at least 48 characters.
 - d. Reporting capabilities that allow sorting of a group or groupings of activities to generate various computer tabular reports and, establishing various planning schedules, as well as bar graphs.
 - e. Identifying any user assigned constraint; e.g., start not earlier than on the printout, adjacent to the activity.
 - f. Activity coding to allow graphic presentation in Gantt or PERT chart format.
 3. Computer generated tabular reports:
 - a. Construction Schedule tabular reports shall include the activity number, activity description, duration, remaining duration, percent complete, early start date, early finish date, late start date, late finish date, total float, precedence relationships,

lead/lag values and shall correlate work days to schedule dates. If the activity is completed or in progress, it shall have actual start or actual finish dates in lieu of the planned dates. The following sorts are required:

- 1) A Schedule of all activities, sorted by activity number, with the CPM Logic.
 - 2) A Schedule of all activities, sorted by early start date without the CPM Logic.
 - 3) A Schedule of all activities, sorted by total float without the CPM Logic.
 - 4) When requested, a Schedule of all activities showing successors, predecessors and constraints.
- b. Computer generated bar graphs of all activities. The following sorts are required:
- 1) Sorted by early start only.
 - 2) Sorted by trade and/or responsibility, by early start.
- c. Computer generated milestone schedule.

E. Submission

1. Upon receipt, the University's Representative shall review the, Detailed Contract Schedule; the University's Representative and the Contractor shall meet to jointly review the Schedule.
2. If the Schedule is found to be acceptable, the schedule will then be approved by the University's Representative as the Baseline Construction Schedule (Contract Schedule).
3. If the Contractor or the University's Representative determines the Contract Schedule to be in need of revision, within 10 working days thereafter, the Contractor shall revise and resubmit the Schedule to the University's Representative for approval, and, upon acceptance thereof, the Schedule shall be approved as the Baseline Construction Schedule (Contract Schedule).

F. Distribution:

1. University's Representative, 3 copies.
2. Contractor's Superintendent.

G. Updating:

1. Contractor shall update the Contract Schedule reflecting progress as of the end of the month and shall submit to the University's Representative for approval by no later than the tenth day of the following month. The updates shall be made as follows:
 - a. The schedule update shall consist of updated CPM Schedule reports similar to the Baseline Construction Schedule. The CPM Schedule reports shall report progress based upon percent complete of actual time and remaining duration. If the General Contractor is behind schedule, or requests an extension to the Contract time, the Contract Schedule must be updated and submitted for review in support of the request. Contract Schedules must be updated any time that delays or a change in scheduled work occurs.
 - b. The updated Contract Schedule shall reflect an up-to-date status of the contract work as completed, and materials furnished and in permanent place that qualify for payment.

- c. The updated Contract Schedule shall reflect the true effect of all processed change orders for the progress month. Subject to the provisions stated in the General Conditions, the General Contractor will be granted an extension to the contract time for the cumulative effect any approved change orders have had on the critical path; refer to General Conditions for the prerequisites for entitlement to a time extension.
 - d. The updated Contract Schedule shall include all delays for the progress month. Subject to the provisions stated in the General Conditions, the Contractor will be granted an extension to the contract time for the cumulative effect any excusable delay(s) had on the critical path. No time extension will be granted for a claimed delay, unless the General Contractor can demonstrate to the satisfaction of the University's Representative the claimed delay affected the controlling operation or operations of the project. To receive an extension to the contract time, the following conditions must be met:
 - 1) Written notice has been provided, within 7 days of the delay.
 - 2) The written notice meets the notice requirements as outlined in the General Conditions.
 - 3) The Contractor has met the conditions of the General Conditions, all of which are prerequisites for entitlement of an extension of the contract time. The Contractor may submit, with the written notification or with the updated Construction Schedule, a CPM sub-net sketch that delineates the activities that were affected by the delay and the effect the delay had on the critical path. No time extension will be granted if the Contractor has not met the requirements of the General Conditions, or if the Contractor has not satisfactorily demonstrated that the claimed delay affected the critical path. Accordingly, all delays not incorporated into the updated Construction Schedule shall be deemed denied by the University.
2. At the updating, in addition to the above, the Contractor shall provide short interval schedule reports, which include:
 - a. A bar graph spanning 1 month prior to the datum line to 2 months beyond the datum line.
 - b. A " Four-Week Look Ahead" or predicated status report, covering the work within the next 4 week period, with activities sorted by early start.
 3. The Contractor shall provide an Accompanying Narrative Report as needed to explain changes to the schedule, changes to the critical path and shall include a list of critical activities that require action from the University's Representative. The Accompanying Narrative Report shall include a listing of all delays that affected the critical path and shall clearly explain the impact the claimed delay(s) had on the critical path and shall include an account audit of days lost/gained.
 4. Other conditions under which additional schedule updating will be required are as follows:
 - a. When delay in completion of any work items or sequence of work items result in an indicated extension of the project completion.
 - b. When delays in submittals or deliveries or work stoppages known to the General Contractor are encountered that make re-planning or rescheduling of the work necessary.

- c. When the schedule does not represent the actual prosecution and progress of the work.
5. Subject to all other requirements of the Contract Documents, nothing in these requirements shall be deemed to be a usurpation of the Contractor's authority and responsibility to plan and schedule the Work.
6. Distribute copies as required for initial distribution and monthly distribution.

1.3 RECOVERY PLAN

- A. If Contractor is behind schedule by more than ten (10) calendar days for any stage of work, based on the updated Contract Schedule after incorporating all approved time extensions, Contractor shall submit to The University's Representative within five (5) working days of notification of such delay, a "Recovery Plan." The Recovery Plan shall be based on proposed revisions to Contract Schedule for the next sixty (60) calendar day period and shall show how Contractor intends to bring the work back on schedule. The Recovery Plan shall also include a written description of the measures that Contractor intends to take without additional cost to The University to regain schedule compliance. The Recovery Plan activities shall be identified according to their relationship to activities on the accepted schedule.
- B. Should Contractor fail to submit and execute such Recovery Plan, The University shall have the option to require Contractor to employ any or all measures that The University deems fit to regain schedule compliance without additional cost to The University.
- C. The Recovery Plan submitted by Contractor, upon acceptance by The University's Representative, shall be incorporated into the Contract Schedule during the next update.
- D. Contractor will be required to submit a Recovery Plan for each update that indicates that the work progress is more than ten (10) calendar days behind schedule.
- E. Should Contractor dispute the determination of The University's Representative regarding the status on Contract delay, such dispute shall not relieve the Contractor of the responsibility to comply with the requirements of this Section and other related Sections until the dispute is resolved per Article 4 of the General Conditions.

1.4 TIME CONTROL

- A. Set up control procedures so that approved schedules are adhered to. Contractor's responsibility is to properly notify University's Representative of anticipated and actual time delays (refer to General Conditions).
- B. Time extension requests shall be submitted in accordance with the provisions of General Conditions.
- C. The General Contractor's time extension request shall be reviewed and evaluated by the University's Representative. A request for the extension shall be deemed denied if not responded to by University's Representative within 21 days.

LAZY K RESTORATION
UNIVERSITY OF CALIFORNIA, MERCED
MERCED, CALIFORNIA

PROJECT NO.: **660175 1B 19900**

PART 2 - PRODUCTS (NOT USED)

PART 3 - EXECUTION (NOT USED)

END OF SECTION 01 31 45

SECTION 01 33 23
SHOP DRAWINGS, PRODUCT DATA AND SAMPLES

PART 1 - GENERAL

1.1 REQUIREMENTS INCLUDED

- A. Shop Drawings, Product Data, and Samples shall be submitted to the University's Representative only in connection with proposed substitutions or when specifically required by the Specifications. Contractor will, however, be required to certify in writing that materials to be provided will be as specified by individual Specification Sections. The University's Representative will not review any other such submittals. Product Data and Samples for proposed substitutions shall be submitted to University's Representative in accordance with Section 01 25 00 Product Options and Substitutions. Contractor shall be responsible for obtaining copies of Shop Drawings, Product Data, and Samples as it may require for its own use.

1.2 RELATED REQUIREMENTS

A. Definitions

- 1. The terms "Shop Drawings" and "Product Data" as used herein also include, but are not limited to fabrication, erection, layout and setting drawings, manufacturers' standard drawings, descriptive literature, catalogues, brochures, performance and test data, wiring and control diagrams as well as all other drawings and descriptive data pertaining to materials, equipment, piping, duct, conduit systems, and methods of construction as required to show that the materials, equipment, or systems and the positions thereof conform to the Contract Documents.
- 2. As used herein, the term "manufactured" applies to standard units usually mass-produced. The term "fabricated" means items specifically assembled or made out of selected materials to meet individual design requirements. Shop Drawings shall establish the actual detail of all manufactured or fabricated items, indicate proper relationship to adjoining Work, and amplify design details of mechanical and electrical equipment in proper relationship to physical spaces in the structure.

B. Manufacturer's Instructions

- 1. Where any item of Work is required by the Contract Documents to be furnished, installed, or performed in accordance with a specified product manufacturer's instructions, Contractor shall procure and distribute the necessary copies of such instructions to the University's Representative and the Contractor shall furnish, install, or perform the Work in strict accordance therewith.

C. Submittal Schedule

- 1. The minimum time required by University's Representative and University's Design Professional to review and process Shop Drawings, Product Data and Samples shall be 7 days after receipt.
- 2. The Contractor shall submit a schedule for submission of Shop Drawings, Product Data, and Samples (the "Submittal Schedule"). The schedule shall include the Contractor's time to process the submittal(s), and the time required

for review by the University's Representative and University's Design Professional. The schedule shall be agreed upon by the University's Representative, the University's Design Professional, and the Contractor in order that submittals will be available when needed by the construction process and so that each party can plan its workload in an orderly manner. All required submittals shall be initially submitted as so not to impact the procurement and installation and also factor in any resubmittal durations.

3. Contractor shall prepare the Submittal Schedule in the form contained in the Submittal Schedule (Exhibit 6) and coordinate it with the Contract Schedule. No submittals will be processed prior to University's Representative and University's Design Professional receiving and approving the Submittal Schedule, unless an exception is made by the University's Representative.
4. In preparing the Submittal Schedule, the Contractor must first determine from the Contract Schedule the date the particular item is needed for the Work. Working backwards, the Contractor will add the required number of days for shipment, time for fabrication, and similar items to determine the date of the first submittal. Contractor shall be responsible for the impact to the schedule resulting from submittals that do not conform to contract requirements. Contractor shall make reasonable allowances in the Submittal Schedule for the re-submittal of items that do not conform to contract requirements.
5. The Submittal Schedule shall be adjusted to meet the needs of the construction process and the Contract Schedule. Submit 2 copies of the Submittal Schedule after it is completed and each time it is updated by the Contractor.

1.3 SHOP DRAWINGS

- A. Present information required on Shop Drawings in a clear and thorough manner. Identify details by reference to drawing and detail, schedule and/or room numbers shown and specified.
- B. The Contractor shall prepare Shop Drawings that comply with the Requirements of Section 01 78 39 Project As-Built Documents.

1.4 PRODUCT DATA

- A. Preparation
 1. Clearly mark each copy to identify pertinent products or models.
 2. Show performance characteristics and capacities.
 3. Show dimensions and clearances required.
 4. Show wiring or piping diagrams and controls.
- B. Manufacturer's standard schematic drawings and diagrams
 1. Modify the standard schematic drawings and other diagrams to delete information that is not applicable to the Work.
 2. Supplement standard information to provide information specifically applicable to the Work.
 3. Clearly indicate manufacturer's model or part number intended for Project.

C. Material Safety Data Sheets

1. Material Safety Data Sheets (MSDS) shall be submitted for all hazardous substances so defined by the State of California. MSDS shall also be provided for all substances furnished under this contract that are not available to the general public from retail outlets; e.g., paints, coatings, lacquers, varnishes, sealers, removers, thinners, solvents, adhesives, cleaners, acids, putty, fillers, disinfectants, fungicides, pesticides, gases, oils, lubricants, treatments, liquid-applied flooring, etc.

1.5 SAMPLES

A. Samples shall be of sufficient size and quality to clearly illustrate the following:

1. Functional characteristics of the products with integrally related parts and attachment devices.
2. Full ranges of color, texture and pattern or as specified by the University's Representative.
3. Or as specified.

B. Field Samples and mock-ups (as required)

1. Erect at the Project site, at a location as directed by the University's Representative;
2. Size: As specified;
3. Fabricate each Sample and mock-up to be complete and fully finished;
4. Remove mock-ups at conclusion of the Work;
5. Or as specified.

1.6 LEED™ SUBMITTAL INFORMATION - (NOT USED)

A. All information noted in Section 01 81 13 LEED® Requirements shall be noted on the cover of every submittal including, but not limited to:

1. Distance in miles from final assembly location to project site;
2. All recycled content information;
3. All FSC certified wood information;
4. All electric, natural gas and water efficiency information;
5. VOC and other LEED® related issues.

B. Any submittals not containing this information on the cover will be rejected.

1.7 CONTRACTOR'S REVIEW OF SUBMITTALS

- A. Review, edit as appropriate, and stamp Shop Drawings, Product Data, and Samples prior to submission. Submittals shall clearly show that they have been reviewed by the Contractor for conformance with the requirements of the Contract Documents and for coordination with other Sections. Contractor's stamp and signature shall indicate that the submittal has been reviewed by the Contractor for conformance with the Contract requirements. Submittals that do not comply with this paragraph shall not be reviewed.

- B. Determine and verify
 - 1. Field measurements.
 - 2. Field construction criteria.
 - 3. Catalog numbers and similar data.
 - 4. Conformance with Contract Documents.
- C. Coordinate each submittal with requirements of the Work and of the Contract Documents.
- D. Notify the University's Representative and University's Design Professional in writing, at time of submission, of any changes in the submittals from requirements of the Contract Documents.
- E. Do not proceed with fabrication or Work that requires submittal review approval.

1.8 SUBMITTAL REQUIREMENTS

- A. The Contractor shall:
 - 1. Submit items in a group or in a sequence in which provide the University's Representative with sufficient information to review items of Work which require coordination with each other. Submissions that do not provide sufficient information to review items of Work requiring coordination with each other shall be returned to the Contractor for re-submittal.
 - 2. Submit submittals promptly in timely manner to avoid delay in the Work or in the Work of any Separate Contractor.
 - 3. Submit a completed Exhibit 23 Material Submittal Approval Form with every submittal.
 - 4. Submit new samples as required for initial submittal.
 - 5. University's Representative has the option to request electronic submission of documents in lieu of blue line reproductions.
- B. Number of Submittals Required
 - 1. Shop Drawings: Submit electronic documents of shop drawings to the University's Representative. The University will provide access to an online document depository for transmission of Shop Drawings. Verify Quantity Required. University's Representative has the option to request blue line reproductions of documents in lieu of or in addition to electronic documents.
 - 2. Project Data and Non-Reproducible Submittals: Submit electronic documents of Project Data to the University's Representative. The University's Design Professional shall return an electronic copy with review comments to the Contractor.
 - 3. Samples and Non-Reproducible Submittals: Submit number as specified in individual Specification Section(s) to University's Representative.
 - 4. University may require submittals to be submitted electronically in the format of AUTOCAD® (latest version available at date of Bid). Files must be ORIGINAL.DWG format. Electronic media must be CD-ROM. One set of original plots must be provided with the electronic media.
 - a. Drawings are to use a specified title block, orientation and north arrow provided by the University.

- b. All actual Drawings are to be done on Model space and plot set up/title block are on Paper space.
- c. Shop Drawing size should be 30"x42" unless is requested differently by the University's Representative.
- d. All Cross references within the same AUTOCAD® Drawing must be bound.

C. Submittals shall contain:

1. A unique number. Submittal Numbering shall be by specification number with incremental numerical suffix as necessary for each resubmission. For example, the first submittal of a specification section will be 'XX XX XX-001'. The second submittal will be 'XX XX XX-001-2'.
2. Actual date of submission, date of submission as shown on Submittal Schedule, date response due, and dates of any previous submissions.
3. Project name and number.
4. Contract identification.
5. The names of:
 - a. Contractor.
 - b. Subcontractor.
 - c. Supplier.
 - d. Manufacturer.
 - e. Bid Package Number if applicable.
6. Identification of the product with the Specification Section number.
7. Field dimensions clearly identified as such.
8. Relation to adjacent or critical features of the Work or materials including interaction with work of other trades.
9. Reference standards such as American Society for Testing and Materials (ASTM) or Federal Specification (FS) numbers.
10. Identification of changes from requirements of the Contract Documents.
11. Identification of revisions on re-submittals. Note any departures from the Contract Documents or changes in previously reviewed submittals that were not commented upon by the University's Representative.
12. An 8 by 3 inch blank space for review stamps.
13. Contractor's stamp, initialed or signed, certifying to the review of the submittal; verification of materials field measurements and conditions; and compliance of the information within the submittal with requirements of the Work and of the Contract Documents.
14. Contractor shall submit submittal(s) with transmittal provided by the University's Representative.

D. Resubmission Requirements

1. Shop Drawings and Product Data
 - a. Note any departures from the Contract Documents or changes in previously reviewed submittals that were not commented upon by the University's Representative.
 - b. University's Representative and the University's Design Professional will review a total of 2 submittals for the same item at no cost to the Contractor. The cost for the review of more than 2 submittals of the same item shall be deducted from the Contract Sum.
2. Samples: Submit samples as required for review/approval.

E. Distribution

1. Reproduce and distribute copies of Shop Drawings and Product Data that carry the University's Representative's review stamp, to the following locations:
 - a. Contractor's Project site file.
 - b. Record documents file maintained by the Contractor.
 - c. Separate Contractors.
 - d. Subcontractors.
 - e. Supplier, manufacturer or fabricator.
2. Distribute Samples that carry the University's Representative's review stamp as directed.
3. Provide electronic copies of Shop Drawings and Product Data that carry the final approved review stamp to the University's Representative for file.

F. University's Representative and the University's Design Professional will review Contractor's submittals, such as Shop Drawings, Product Data and Samples, for the limited purpose of checking for conformance with information given and the design concept expressed in the Contract Documents. Review of such submittals is not conducted for the purpose of determining the accuracy and completeness of other details such as dimensions and quantities, or for substantiating instructions for installation or performance of equipment or systems, all of which remain the responsibility of the Contractor as required by the Contract Documents.

PART 2 - PRODUCTS (NOT USED)

PART 3 - EXECUTION (NOT USED)

END OF SECTION 01 33 23

**SECTION 01 35 00
SPECIAL REQUIREMENTS**

PART 1 - GENERAL

1.1 DEFINITION OF PROJECT SITE

- A. Contractor's use of the Project site for the Work and storage is restricted to the areas designated on the Drawings.
- B. The Project site is located in Madera County, at 8314 S Santa Fe Ave, Chowchilla, CA 93610

1.2 WORK HOURS

- A. No Work shall be done outside of standard Monday through Friday 7:00 A.M. to 5:00 P.M. working hours, on holidays or weekends unless prior written approval has been obtained from the University's Representative.

1.3 SITE INGRESS AND EGRESS

- A. Contractor shall construct and maintain temporary access roads and laydown areas as shown on in the plans. All temporary access roads shall comply with all applicable laws, regulations & permit requirements.

1.4 SITE RESTRICTIONS

- A. OUT OF BOUNDS AREAS
 - a. Areas designated as Environmentally Sensitive by Designated Biologist.
 - b. Any area not explicitly noted as being within the Project Site.

1.5 ROADS

- A. Existing roads and existing or planned construction roads shall be used for construction access within the limits defined herein.
- B. Contractor shall take all necessary precaution to insure the safety of Visitors at all times.
- C. Contractor must obtain prior written approval from Madera County to block streets or parking areas at any time.
- D. The Contractor shall clear all roads, parking areas and sidewalks affected by the Contractor's operations. This will include the immediate removal of dust, dirt, or any other debris or detritus so that roads and sidewalks are maintained in a safe and usable condition.

1.6 PARKING

- A. The Contractor parking shall be limited to the area identified as Equipment Yard in the Contract Documents.

1.7 TRAFFIC CONTROL

- A. The Contractor shall adopt all practical means to minimize interference to traffic. Access to other facilities under construction shall be maintained at all times. The Contractor shall provide a schedule of any activity that will impact traffic, or any planned closing of the streets, for approval by the University's Representative and shall give a minimum of 14 working days notice before closing any street or access. Contractor is responsible for obtaining approval from Madera County before closing any street or access.
- B. Contractor shall furnish at Contractor's expense all barricades, lights, and other devices and means necessary to control traffic and shall maintain these devices at all times to protect the public and/or Work.
- C. It is the responsibility of the Contractor performing Work on or adjacent to a highway to install and maintain such devices as are necessary to provide safe passage for the traveling public through the Work, as well as for the safeguard of workers. Before Work begins, traffic control plans for handling traffic through a construction or maintenance Project shall be submitted to and approved by the University's Representative and public agency or authority having jurisdiction over the highway, in accordance with Chapter 5 of the CalTrans Traffic Manual.
- D. The Contractor shall comply with the provisions of 01 35 40 Environmental Mitigation and the provisions of 01 11 00.10 Natural Resource Avoidance and Minimization Measures.
- E. The Contractor shall ensure that all of the General Contractor's activities that affect traffic control, road use, materials delivery, equipment delivery, rights of way and preservation of 3rd party access rights are coordinated with those of all Separate Contractors.

1.8 SURROUNDING SITE CONDITION SURVEY

- A. Prior to commencing the Work, Contractor, Designated Biologist, and University's Representative shall tour the Project site together to examine and record damage to existing adjacent buildings, campus streets and city streets, bicycle paths, sidewalks, and all other improvements. This record shall serve as a basis for determination of subsequent damage due to Contractor's operations and shall be signed by all parties making the tour. Any cracks, sags, or damage to the adjacent buildings and improvements not noted in the original survey, but subsequently discovered, shall be reported to the University's Representative.

1.9 INTERRUPTION OF BUILDING SERVICES – NOT USED

1.10 PROTECTION OF EXISTING STRUCTURES AND UTILITIES

- A. The Drawings show, if applicable, existing above and below grade structures, drainage lines, storm drains, sewers, water, gas, electrical, hot water, and other utilities that are known to the University.
- B. Contractor shall locate all known existing installations before proceeding with construction operations that may cause damage to such installations. Existing installations shall be kept in service where possible and damage to them shall be repaired at no additional cost to the University.
- C. Existing underground structures and utilities shall be kept in service unless prior approval to interrupt or shutdown service is obtained from University's Representative. If damaged, they shall be repaired by the Contractor with no adjustment of Contract Sum or Contract Time.
- D. The Contractor shall coordinate all Work with the operations of separate Contractors as needed. This shall include, but not be limited to, the responsibility of the Contractor to coordinate with University's separate Site Infrastructure Phase 4 Contractor installing underground utilities, Ansel Adams and Ranchers Road street improvements, sidewalks and streetlights. Such coordination should take place prior to any excavation or trenching operations by the Contractor.
- E. If any other structures or utilities are encountered, the Contractor shall request University's Representative to provide direction on how to proceed with the Work.
- F. If any structure or utility is damaged by the Contractor, the Contractor shall take appropriate action to ensure the safety of persons and property.
- G. No Work is to be performed on energized electrical equipment unless scheduled with the University's Representative. The University reserves the right to specify specific conditions for all Work involving energized high-voltage electrical equipment.
- H. General Contractor shall uncover, prior to any earthwork for new construction, all existing piping where crossings, interferences or connections are shown on the Drawings, from 1 foot below proposed construction limit to the existing ground surface. Any variation in the actual elevations and the indicated elevations shall be brought to the University's Representative's attention. If the Contractor does not expose all existing utilities, General Contractor shall not be entitled to additional compensation for Work necessary to avoid interferences.
- I. If interferences occur at locations other than the general locations shown on the Drawings, and such utilities are damaged before their locations have been established, or create an interference, the Contractor shall notify the University's Representative and a method for repairing the damage or correcting the interference shall be supplied by the University's Representative. Payment for additional Work due to interferences not shown on the Drawings shall be in accordance with the General Conditions.

- J. Care shall be exercised to prevent damage to adjacent facilities including walks, streets, curbs, and gutters; where equipment will pass over these obstructions suitable planking shall be placed. Damaged facilities, due to the Contractor operations, shall be removed and replaced at the Contractor's expense.

1.11 PROTECTION OF PERSONNEL

- A. Contractor shall take proper precautions to ensure the safety of all persons at all times during the construction period.

1.12 PROJECT SITE SECURITY

- A. Contractor shall be responsible for ensuring all personnel comply with Project identity sticker requirements established by the University's Representative. Project identity stickers to be provided by the University.
- B. All persons working on the Project site shall receive a site safety briefing and Natural Resource Awareness Training from the University before being issued a Project identity sticker and prior to being allowed to start work.
- C. Keys required for access to the Project, if any, will be issued by the University's Representative to the General Contractor only. It will be General Contractor's responsibility to open areas for Subcontractors. Certain types of Projects may require more than one set of keys. Additional keys will be issued to General Contractor, if requested. General Contractor may not duplicate issued keys.
 - 1. At completion of Project, all keys shall be returned to University's Representative. Failure to return keys shall obligate General Contractor for all costs incurred due to necessary rekeying.

1.13 CONSTRUCTION STAGING & MULTIPLE CONSTRUCTION CONTRACTS

- A. The following describes the scheduling of the Work and the coordination required for the Work done by Separate Contractors:
 - 1. The University reserves the right to let other construction contracts.
 - 2. The following projects may be in progress at times during this project:
 - a. California High Speed Rail Vernal Pool Restoration Project
 - 3. Disagreements between the Contractor and other Separate Contractors about concurrent use of Work areas or access to the Project site which are not resolved by the participants shall be referred to the University's Representative and the Contractor agrees to abide by the University's Representative's determination as to concurrent use or priority of access and to perform its Work in compliance with the University's Representative's resolution at no additional cost to the University.

- B. All material and equipment for construction operations shall be brought in and the Work so conducted as to avoid any interference with existing University facilities or their normal operations, and with concurrent construction Work by other Separate Contractors.

1.14 FINAL EXAM SCHEDULE – NOT USED

1.15 WORK SITE DECORUM

- A. Extreme care to limit noise and odors shall be taken at all times. Loud or unnecessary conversation shall be avoided. The playing of radios tapes, or compact discs shall be strictly prohibited.
- B. Contractor shall control the conduct of its employees and those of its subcontractors and suppliers so as to prevent interaction initiated by said employees with University of California Merced students, staff, or other individuals (except those associated with the Project), on or adjacent to the Project site. Without limitation, unwanted interaction by these employees includes whistling at, motioning toward, or initiating conversations with passersby. In the event that any employee initiates such unwanted interaction, or utilizes profanity, Contractor shall, either upon request of University's Representative or on its own initiative, replace said employee with another of equivalent technical skill, at no additional cost to the University.
- C. Smoking is prohibited in and within 20 feet of any entrance, window, or air intake of all University buildings and in enclosed areas. Smoking will not be allowed in the construction area. Smoking will be allowed in a designated area within the construction storage yard only.
- D. Firearms are prohibited on Project site.
- E. Alcoholic beverages are prohibited on Project Site.
- F. Pets are prohibited on the Project site.

1.16 PUBLICITY

- A. Contractor shall not release any information, story, photograph, plan or drawing relating to the Project to anyone, including press or other public communications medium, except as submitted and approved for release by the University's Representative.

1.17 PROJECT SIGN

- A. No signs or advertisements will be permitted on the Project site, except with express permission of University's Representative.

1.18 JOB OFFICE

- A. Space on the Project Site is limited. Trailer space must be requested and approved by the University's Representative. Storage and office trailers are to be located in the temporary laydown area as shown on the Site Logistics Plan. Space will be allocated by the University's Representative. Contractor shall provide and maintain all temporary facilities as required for completion of the Project.

1.19 SALVAGE

- A. All material and equipment removed as part of this Project is the property of the Contractor and shall be removed from the Campus and legally disposed of, unless otherwise stated in the Contractor's "Scope of Work".

1.20 CLEANUP

- A. During the progress of the Work, the Contractor shall keep the Project site in a neat and clean condition that is free of debris to the satisfaction of the University's Representative. All materials and debris accumulated in conjunction with completing this Work shall be disposed of in the jobsite trash dumpsters provided by the Contractor and disposed of off campus. Contractor shall not use University refuse containers.

1.21 UNIVERSITY FURNISHED ITEMS – NOT USED

1.22 JOB CONDITIONS

- A. Protection: Where roof edge does not terminate in a parapet wall and/or where Work is in progress overhead and materials or objects could potentially fall, the Contractor is required to construct temporary covered pedestrian walkways over each building entrance. Walkway covers shall extend out 12 feet in length for the first floor and an additional 4 feet for each additional floor of the building. Walkway covers shall extend from face of building. Contractor shall be required to place and maintain yellow safety construction flagging or ropes with signage to prevent pedestrians from coming within 25 feet of Work in progress overhead and to route pedestrians in and out of building entrances.
- B. Safety Precautions: Perform Work in such a manner as to prevent damage to existing facilities to remain or to be salvaged. Hazardous Work shall not be left standing or hanging, but shall be knocked or pulled down to avoid damage or injury to employees or the public.
- C. Crane Operation, Staging and Storage
 - 1. Operator Training and Crane Certification: Prior to starting crane operations, General Contractor shall provide copies of operator's training and crane certification to the University's Representative.
 - 2. Crane Staging Area: Contractor shall be required to coordinate with the University's Representative a minimum of 5 working days in advance of loading and removal of materials from the roof. Contractor is responsible for providing necessary staging area for crane.
 - 3. Storage: Contractor shall not be allowed on-site crane storage unless with the prior written approval of the University's Representative.

1.23 NOT USED

1.24 PROJECT SITE SUPERINTENDENT

- A. Contractor shall employ a competent Project Site Superintendent/Foreman satisfactory to the University's Representative. The Project Site Superintendent/Foreman shall be in attendance at the Project site at all times during the performance of the Work. Project Site Superintendent/Foreman shall represent the Contractor and communications given to and received from the Project Site Supervisor shall be binding on Contractor.
- B. The Contractor shall submit to the University's Representative the qualifications of the Project Site Superintendent/Foreman prior to commencement of the Work. The University's Representative shall approve the Project Site Superintendent/Foreman based on his/her experience with projects similar to type, scope, size, and complexity.
- C. The Project Site Superintendent/Foreman approved for the Project by the University's Representative, must be able to proficiently read, write and verbally communicate in English. The Project Site Superintendent/Foreman may not perform the Work of any trade, pick-up materials, or perform any Work not directly related to the supervision and coordination of the Work at the Project site while Work is in progress.
- D. Failure to maintain a Project Site Superintendent/Foreman on the Project site at all times Work is in progress shall be considered a material breach of this Contract, entitling University to terminate the Contract or alternatively, issue a stop Work order until the Project Site Superintendent/Foreman is on the Project site. If, by virtue of issuance of said stop Work order, General Contractor fails to complete the Contract on time, General Contractor will be assessed Liquidated Damages in accordance with the Agreement.
- E. If the Project Site Superintendent/Foreman fails to perform to the satisfaction of the University's Representative, the University's Representative may, upon 15 days written notice, require the General Contractor to remove the Project Site Superintendent/Foreman from the Project and replace the Project Site Superintendent/Foreman with a replacement acceptable to the University's Representative.
- F. If the Contractor elects a replacement of the Project Site Superintendent/Foreman, such replacement shall be discussed with the University's Representative prior to actual replacement. The same criteria employed by the University's Representative to approve the initial Project Site Superintendent/Foreman shall also apply to the University's Representative's approval of any subsequent Project Site Superintendent/Foreman.

1.25 OTHER CONTRACTOR SITE PERSONNEL

- A. In addition to the Project Site Superintendent/Foreman, the Contractor shall provide site personnel of quality and quantity sufficient to carry out all of the on-site Contractor responsibilities described in the Contract Documents. See Instructions to Bidders for other site personnel requirements that may also be required.

LAZY K RESTORATION
UNIVERSITY OF CALIFORNIA, MERCED
MERCED, CALIFORNIA

PROJECT NO.: **660175 1B 19900**

PART 2 - PRODUCTS (NOT USED)

PART 3 - EXECUTION (NOT USED)

END OF SECTION 01 35 00

SECTION 01 35 40
ENVIRONMENTAL MITIGATION

PART 1 - GENERAL

1.1 WORK INCLUDED

A. Related Sections

1. ~~01 81 13 LEED® Requirements~~
2. ~~01 74 19 Site Waste Management Program~~
3. 01 35 43 Hazardous Materials Procedures

B. Requirements

1. The Environmental Mitigation requirements for this Project are recorded in this Specification Section. The mitigation measures may include, but are not limited to, procedures and standards to control:
 - a. Dust Palliation
 - (1) All construction, demolition, excavation, extraction or other earthmoving activities shall comply with the San Joaquin Valley Air Pollution Control District (SJVAPCD) Regulation VIII - Fugitive PM10 Prohibitions.
 - (2) All disturbed areas, including storage piles, shall be sprinkled with water or other dust control agents/chemical stabilizers acceptable to SJVAPCD, or shall be covered with vegetative ground cover, so as to effectively prevent dust emissions. Additional watering or acceptable dust control agents/chemicals shall be applied during dry weather or windy days until dust emissions are not visible.
 - (3) Trucks hauling dirt and debris shall be effectively wetted and/or maintain not less than six inches freeboard and/or cover the top of the load to reduce wind blown dust or spills.
 - (4) Dirt or debris spilled onto paved surfaces shall be swept up immediately to reduce resuspension of particulate matter caused by vehicle movement. Approach routes to the Project site shall be cleaned daily of construction related dirt or mud. The use of dry rotary brushes and blower devices is prohibited except where preceded by sufficient wetting to limit visible dust emissions and the prior written approval of the University's Representative.
 - (5) On-site stockpiles of excavated material shall be covered or watered.
 - (6) Traffic speeds on unpaved roads shall be limited to 15 mph.
 - (7) If an area having 0.5 acres or more of disturbed surface area remains unused for seven or more calendar days, the area must comply with conditions for a stabilized surface area as defined in Rule 8011 of SJVAPCD and General Contractor shall comply with the record keeping requirements specified in Rule 8011 of SJVAPCD.

- b. Other Air Pollutants
 - (1) When feasible, construction equipment should use alternative fuel sources such as propane, natural gas or electricity.
 - (2) Minimize idling time of machinery to a maximum of 10 minutes when construction equipment is not in use.
 - (3) Construction equipment rated greater than 100 horsepower shall have, to the extent feasible, diesel exhaust controlled by use of catalyst-based diesel particulate filters.
 - (4) Use low-emission on-site station equipment.
- c. Noise
 - (1) Construction equipment shall be properly outfitted and maintained with adequate mufflers and other appropriate noise reduction devices to minimize construction-generated noise.
 - (2) Stationary noise sources such as generators or pumps shall be located away from noise sensitive land-uses and occupied buildings.
 - (3) Prior to construction activities, Contractor shall coordinate with the County Parks and Recreation Division to reduce the likelihood that planned events at the Lake Yosemite Park are adversely affected by project construction.
 - (4) Comply with all applicable sound ordinances as required.
 - (5) Should the Contractor need to generate construction noise adjacent to occupied buildings, the Contractor shall inform the University's Representative in writing 14 calendar days prior to generating the noise.
 - (6) The Contractor shall comply with the provisions of Section 01 35 00 Special Requirements with regard to Work Hours.
- d. Odors
 - (1) Work that causes excessive odors shall be performed only after coordination with the University's Representative. Filtering of air intakes to air handling units may be needed to prevent odors and vapors from entering buildings.
 - (2) Contractor shall provide 14 working days advance written notice to the University's Representative in order for advance notices to be forwarded to building occupants. Work stoppage may occur if advance notification has not been coordinated or if odors and vapors from the work are found to generate complaints from building occupants.
- e. Light
 - (1) The Contractor shall minimize up-light and light spill by focusing light sources and using shielding.
 - (2) No light sources shall be directed across the site boundaries.

1.2 ARCHAEOLOGICAL RESOURCES

A. GENERAL

- 1. If during the course of construction, evidence of deposits of historical or archaeological interest is found, the Contractor shall cease the Work affecting the

find and immediately notify the University's Representative and shall not disturb deposits until written notice from University's Representative is given to proceed.

2. Contractor will be compensated for lost time or changes in construction to avoid the find based upon normal change order procedures if Critical Path is affected.

B. Procedures

1. If a potentially significant archaeological find is identified during construction, the University may incorporate into the proposed project design measures that will minimize or eliminate direct impacts to the deposit. These may include avoidance of the site by inclusion in landscaping or open space, placement of fill over the site, and/or project redesign. If this is not feasible, or if such measures will not ensure the avoidance of impacts, the University will ensure that an archaeological testing program is carried out to assess the significance of the find.
2. If a find is determined to be significant, and if it cannot be preserved intact through project design measures, then the University will retain an archaeologist to design and carry out a treatment plan to document the data and/or preserve such scientific samples of the data for which the site is significant as may be appropriate, given the significance of the find.
3. Any significant finds that are recovered shall be retained by University and will be donated to an appropriate cultural or historical center. Unauthorized collection of artifacts is prohibited. If human remains are encountered, Work will be halted and the Merced County Coroner will be contacted immediately by the University's Representative. If human remains are determined to be Native American, the Coroner will notify the Native American Heritage Commission. The Commission will then notify the person it believes to be the most likely descendant. That descendant will work with the University to develop a program for reinternment of the remains and any associated artifacts.

C. When Native American archaeological, ethnographic, or spiritual resources are found, identification and handling of those resources will be conducted jointly by a University appointed Archaeologist and Native American representatives who are approved by the local Native American community as scholars of their cultural traditions. The Archaeologist shall either be certified by the Society of Professional Archaeologist, or meet the Federal Standards appearing in 36 CFR 61. If no approved Native American representative is available, persons who represent tribal government and/or organizations in the surrounding region shall be consulted. If historic archaeological resources are found, identification and handling of those resources will be conducted by historical archaeologists or architectural historians retained by the University. Procedures

1. If a potentially significant archaeological find is identified during construction, the University may incorporate into the proposed project design measures that will minimize or eliminate direct impacts to the deposit. These may include avoidance of the site by inclusion in landscaping or open space, placement of fill over the site, and/or project redesign. If this is not feasible, or if such measures will not ensure the avoidance of impacts, the University will ensure that an

- archaeological testing program is carried out to assess the significance of the find.
2. If a find is determined to be significant, and if it cannot be preserved intact through project design measures, then the University will retain an archaeologist to design and carry out a treatment plan to document the data and/or preserve such scientific samples of the data for which the site is significant as may be appropriate, given the significance of the find.
 3. Any significant finds that are recovered shall be retained by University and will be donated to an appropriate cultural or historical center. Unauthorized collection of artifacts is prohibited. If human remains are encountered, Work will be halted and the Merced County Coroner will be contacted immediately by the University's Representative. If human remains are determined to be Native American, the Coroner will notify the Native American Heritage Commission. The Commission will then notify the person it believes to be the most likely descendant. That descendant will work with the University to develop a program for reinternment of the remains and any associated artifacts.
 4. When Native American archaeological, ethnographic, or spiritual resources are found, identification and handling of those resources will be conducted jointly by a University appointed Archaeologist and Native American representatives who are approved by the local Native American community as scholars of their cultural traditions. The Archaeologist shall either be certified by the Society of Professional Archaeologist, or meet the Federal Standards appearing in 36 CFR 61. If no approved Native American representative is available, persons who represent tribal government and/or organizations in the surrounding region shall be consulted. If historic archaeological resources are found, identification and handling of those resources will be conducted by historical archaeologists or architectural historians retained by the University.

1.3 PALEONTOLOGICAL RESOURCES

A. General

1. If during the course of construction, evidence of deposits of paleontological interest is found, the Contractor shall cease the Work affecting the find and immediately notify the University's Representative. Do not disturb deposits until written notice from University's Representative is given to proceed.
2. Contractor will be compensated for lost time or changes in construction to avoid the find based upon normal change order procedures if Critical Path is affected.

B. Procedures

1. Prior to project construction, construction personnel shall be informed by the Contractor of the potential for encountering significant paleontological resources.
2. If a potentially significant paleontological find is discovered, the Contractor shall cease all operations in the area of the find until a University appointed paleontologist has been afforded the opportunity to assess the significance of the find and implement appropriate measures to protect or scientifically remove the find.

3. Collection of fossil resources by other than the University's consulting paleontologist is prohibited.
4. A University appointed, qualified paleontologist may be intermittently present to inspect exposures of the Merhten Formation, North Merced Gravels, and Riverbank Formation during construction operations to ensure that paleontological resources are not destroyed by project construction.

1.4 NOXIOUS OR TOXIC MATERIALS

A. The Contractor shall ensure that:

1. No noxious or toxic materials shall be used in or around occupied buildings without prior approval of the University's Representative.
2. Chemical wastes shall be stored in covered metal containers and shall be removed from the premises daily.
3. There shall be no accumulations of wastes that create hazardous conditions.
4. Adequate ventilation is provided during use of volatile or noxious substances. Such materials shall only be used after 48 hours previous notification to the University's Representative and preferably on weekends or "down" periods.
5. Chemicals, such as mineral spirits, oil, or paint thinner, are not dumped into storm or sanitary drains or on University property or on any adjoining property.
6. Vehicle maintenance or servicing shall not spill oil or fuel onto the ground and if a spill occurs, it shall be cleaned up immediately and the soil disposed of according to local, State, and/or Federal requirements.
7. Chemical storage, including fuel and oil, shall be double contained.
8. The Contractor's Project Site Superintendent shall be trained in the prevention and correction of spills.
9. Contractor shall have immediate access to spill control equipment, such as absorbent, shovels, and containers.

1.5 REMOVAL AND DISPOSAL OF EXCESS SOIL

- A. All materials and debris accumulated in conjunction with completing this Work shall be disposed of legally by the Contractor off the Project Site. Contractor shall not use University refuse containers. Clear soil spoils shall be transported and deposited at a designated location as directed by the Designated Biologist.
- B. Contractor is to coordinate with University Representative and Designated Biologist to identify the location of a temporary staging area for storage of excavated soil on the Project Site. The intent of this area is to serve as a nearby storage area for excavated soil intended by the Contractor to be used for backfill or fill later in the project. This area is to be restored to original condition after its use is no longer required.

1.6 REMOVAL AND DISPOSAL OF WASTE MATERIALS

- A. All waste materials resulting from the process of clearing and construction shall be legally disposed of by the Contractor as follows:

1. All refuse and debris, concrete and other inert materials, combustible and incombustible substances, resulting from the processes of construction, shall be removed from the Project Site. The Contractor shall not use any refuse container belonging to the University. The Contractor shall provide debris boxes for the use of the Contractor and all of their Subcontractors and dispose all debris off-site excepting chemical and hazardous waste which shall be disposed of by the Subcontractor generating the waste. Contractor shall be responsible for depositing their waste into the debris boxes provided by the Contractor on a daily basis.
 2. Chemical Waste: All chemical waste, including solvents, oils or any other material that may be harmful to plant life, shall be disposed of in accordance with local, State and/or Federal regulations. Chemical waste shall not be stored on the University's property. At completion of Work, any contaminated soil shall be removed from the Project Site and replaced with good soil by the Contractor at no additional cost to the University.
- B. The Contractor shall not burn or bury rubbish or waste materials on the Project Site.
- C. During construction, the Contractor shall maintain buildings, premises and property free from accumulations of waste materials and rubbish. The Contractor shall legally dispose of such waste, rubbish and debris at reasonable intervals off the Project Site.

1.7 CONTROL OF NONNATIVE & INVASIVE PLANT SPECIES

- A. Contractor shall ensure that seeds from invasive plant species are not transported into the Campus site by earth moving equipment. At a minimum, the Contractor shall ensure that:
1. All earth moving equipment shall be washed down (wheels, under-carriage, bucket/bed, etc.) prior to being transported to the Project site. All earth moving equipment shall be clean and free of seeds or other plant material before being brought on site.
 2. The Contractor shall notify the University's Representative and Designated Biologist of the source location of all off-site fill material a minimum of 10 calendar days prior to importing material to the Project site and appropriate steps shall be taken to minimize the potential for invasive species to colonize areas disturbed during construction due to use of such fill.
 3. Any organic material used during project construction for erosion control, or any material used for hydroseeding or revegetating disturbed areas is certified free of invasive species.

1.8 PROTECTION OF SENSITIVE AREAS OUTSIDE PROJECT SITE BOUNDARY

- A. Contractor shall operate strictly within the confines of the Project Site as described in the plans.
- B. In no instances shall construction related vehicles or Contractor's personnel travel beyond the Project site boundary except on roads.

- C. In no instance shall the Contractor allow any material, whether solid or liquid, to migrate from the Project site across, except when said material is being removed from the Project site in accordance with the Contract Documents.

1.9 NATURAL RESOURCE AWARENESS TRAINING FOR CONSTRUCTION PERSONNEL

A. Training Program

1. Prior to working on the Project site, all construction personnel shall attend a training program provided by the University Representative on Monday and Wednesday mornings at 7:30am or when agreeable with University's Representative. The training will include at minimum, a description of the species at risk and their habitat, the importance of the species and their habitat, the general measures being implemented to conserve the sensitive areas/species, and the boundaries within which the project may be accomplished.
2. The training shall be conducted in English and shall consist of a presentation and the distribution of appropriate literature. The Contractor shall ensure that all Subcontractor and Contractor supplier personnel attend a training session before they start working at the Project site.
3. The Contractor shall ensure that the following site regulations, which will be identified in the Training program, are adhered to:
 - a. All food related items shall be properly disposed of, and signs indicating that the feeding of wildlife is prohibited shall be placed at the Project site.
 - b. Vehicle traffic shall occur primarily between dawn and dusk, and shall be limited to 20 mph to reduce the potential for wildlife road mortality.
 - c. Any trench or pit shall be constructed in such a way as to provide ramps of either fill or planks to prevent kit fox and other species from becoming entrapped.
 - d. Pipes, culverts, etc. greater than four inches in diameter shall be stored in such a way as to prohibit foxes or other species from using these areas as temporary refuge. In addition, these structures shall be thoroughly inspected each morning for kit fox or other species.
 - e. No firearms shall be allowed on University Property.
 - f. No pets shall be permitted on University Property.
 - g. The use of pesticides on the Project site by the General Contractor, including but not limited to rodenticides, insecticides and herbicides, is prohibited unless prior written approval of the University's Representative is obtained.
 - h. Construction vehicles shall be limited to a maximum speed of 10 mph in the vicinity of breeding ponds of California tiger salamander during the salamander movement period. The location of the breeding ponds and dates of the movement period shall be identified by the University's Representative.

1.10 AUTHORITY OF THE UNIVERSITY'S REPRESENTATIVE TO SUSPEND WORK

- A. The University's Representative has the authority to suspend construction work when such work causes or threatens to cause harm to sensitive habitat or species.
- B. Contractor will be fully responsible for any and all damages and sanctions placed against the Project for any violations of these requirements.

1.11 SURFACE WATER CONTROL

- A. All portions of the Work shall be kept free of standing water at all times during construction of the Work herein specified. Where required, temporary drainage ditches, berms, or pumping systems shall be constructed to divert drainage water away from the Project site and the resultant water shall be carried to the nearest water course approved by the University's Representative and disposed of without erosion to the surrounding area. Care shall be taken to prevent silting of the water courses. Silt that is deposited, as a result of the Work in this Project, shall be removed and disposed of by the Contractor, at the Contractor's expense and to the satisfaction of the University's Representative. The General Contractor shall follow CALTRANS "Handbook of Practices, Storm Water Pollution Practice."

PART 2 - PRODUCTS (NOT USED)

PART 3 - EXECUTION (NOT USED)

END OF SECTION 01 35 40

SECTION 01 35 43
HAZARDOUS MATERIALS PROCEDURES

PART 1 - GENERAL

1.1 CONTRACTOR'S RESPONSIBILITY

- A. Except as otherwise specified, in the event Contractor encounters on the Project site material reasonably believed to be asbestos, polychlorinated biphenyl (PCB), lead, or other hazardous substances that have not been rendered harmless, Contractor shall immediately stop work in the area affected and report the condition to the University's Representative in writing. The Work in the affected area shall not thereafter be resumed except by written agreement of University and Contractor if in fact the material is asbestos, PCB, lead, or other hazardous substances and has not been rendered harmless. The Work in the affected area shall be resumed in the absence of asbestos, PCB, lead, or other hazardous substances, or when such materials have been rendered harmless.
- B. Disclose any hazardous substance or condition exposed during the Work to the University's Representative for decision or remedy.
- C. In no event, shall the Contractor install materials that contain asbestos, PCB, lead or other known hazardous materials without specific prior written approval by the University's Representative.
- D. Disposal of lighting ballasts containing PCB's shall be accomplished by the University. The Contractor shall coordinate with the University's Representative regarding a date, location and time for delivery to a location on Campus to be designated.
- E. Regulated Carcinogens by California Code of Regulations (CCR) Title 8, Section 5200 et seq.
 1. Products containing chemicals regulated as carcinogens by California Occupational Safety and Health Act (OSHA) are not allowed for use on University projects. The OSHA regulated carcinogens are:
 - a. 2-Acetylaminofluorene, 5209
 - b. 4-Aminodiphenyl
 - c. Benzidine (and its salts)
 - d. 3,3'-Dichlorobenzidine (and its salts)
 - e. 4-Dimethylaminoazobenzene
 - f. alpha-Naphthylamine
 - g. beta- Naphthylamine
 - h. 4-Nitrobiphenyl
 - i. N-Nitrosodimethylamine
 - j. beta-Propiolactone
 - k. bis-Chloromethyl ether
 - l. Methyl chloromethyl ether
 - m. Ethyleneimine
 - n. Methylene Chloride, 5202
 - o. Methyleneedianiline (MDA), 1535, 5200
 - p. Cadmium, 1532, 5207
 - q. Asbestos, 1529, 5208, 5208.1, 8358

- r. Vinyl Chloride, 5210
 - s. Coke Oven Emissions, 5211
 - t. 1,2-Dibromo-3-Chloropropane (DBCP), 5212
 - u. Acrylonitrile, 5213
 - v. Inorganic Arsenic, 5214
 - w. 4,4'-Methylenebis(2-Chloroaniline) (MBOCA), 5215
 - x. Formaldehyde, 5217
 - y. Benzene, 5218
 - z. Ethylene Dibromide (EDB), 5219
 - aa. Ethylene Oxide (EtO), 5220
 - bb. 1,3 Butadiene, 5201
2. Case-by-case exceptions may be considered for products containing the following COSHA recognized carcinogens:
 - a. Methylene Chloride, 5202
 - b. Cadmium, 1532, 5207
 - c. Inorganic Arsenic, 5214
 - d. Formaldehyde, 5217
 - e. Benzene, 5218
 3. Case-by-case exceptions may only be made when suitable alternative products are not available. Such exceptions are subject to approval by the University's Representative.
 4. Exceptions require that the Contractor shall have an established carcinogen program as required by COSHA and shall submit to University's Representative, a copy of the COSHA Confirmation of Report for COSHA carcinogens.
 5. When exceptions are granted the Contractor is responsible for providing to the University's Representative a copy of the semi-annual Confirmation of Report received from COSHA or, in lieu of that, a copy of the Contractor's semi-annual report as submitted to COSHA at periods not to exceed 6 months, or at project closeout, whichever occurs first.

1.2 ASBESTOS IN BUILDINGS NOTIFICATION

- A. California Health and Safety Code, Section 25915, Chapter 10.4, Division 20 requires UC Merced employees and contractors working for the campus to be notified of the presence of asbestos in buildings constructed prior to 1979. For information about asbestos in specific buildings, contact the University's Representative.
- B. It is important to note that the presence of asbestos does not mean you have been exposed to asbestos. Exposure strictly refers to the inhalation or ingestion of friable asbestos particles. Asbestos becomes friable through drilling, sanding or similar destructive processes usually associated with remodeling or demolition work. Intact, bonded, sealed and undisturbed asbestos does not pose a hazard.
- C. Contractors who disturb or potentially disturb friable or non-friable asbestos must comply with all Federal State and Local rules and regulations regarding hazardous materials.

1.3 LEAD BASED PAINT IN BUILDINGS

- A. The California Department of Health Services requires the certification of employees and supervisors performing lead related construction activities in residential and public

buildings, as defined in Title 17, California Code of Regulations, Division 1, Chapter 8. Lead related construction work is defined in Title 17 as any construction, alteration, painting, demolition, salvage, renovation, repair, or maintenance of any residential or public building, including preparation and cleanup, that, by using or disturbing lead containing material or soil, may result in significant exposure of adults or children to lead.

- B. It is important to note that the presence of lead does not mean you have been exposed to lead. Exposure strictly refers to the inhalation or ingestion of lead dust. Lead becomes dust through drilling, sanding or similar destructive processes usually associated with remodeling or demolition work. Intact, bonded, sealed and undisturbed lead does not pose a hazard.
- C. For information about lead in specific buildings, contact the University Representative
- D. Contractors who disturb or potentially disturb lead must comply with all Federal State and Local rules and regulations regarding hazardous materials.

PART 2 - PRODUCTS (NOT USED)

PART 3 - EXECUTION (NOT USED)

END OF SECTION 01 35 43

**SECTION 01 41 00
REGULATORY REQUIREMENTS**

PART 1 - GENERAL

1.1 CODES, AGENCIES, AND REFERENCES

- A. The Work shall be performed in accordance with Applicable Code Requirements and applicable requirements of all other regulatory agencies, including, but not limited to, the following:
1. Americans with Disabilities Act - Title II.
 2. California Environmental Quality Act.
 3. California Health and Safety Code.
 4. National Fire Protection Association (NFPA).
 5. Federal Occupational Safety and Health Administration.
 6. Federal Clean Water Act, including but not limited to the Storm Water Pollution Prevention requirements.
 7. Federal Endangered Species Act.
 8. Federal Clean Air Act.
 9. Porter-Cologne Water Quality Act, State of California
 10. Endangered Species Act, State of California
 11. California Fish & Game Code, Section 1600, et. seq.
 12. Resource Conservation and Recovery Act (RCRA) and the California Hazardous Waste Control Law.
 13. Comprehensive Environmental Response and Cleanup Liability Act (CERCLA)
 14. California Building Code (CBC)

1.2 STANDARDS AND CODES

- A. Applicable laws, codes, rules, regulations, ordinances and standards
1. Code of Federal Regulations
 - a. Title 33, Navigation and Navigable Waters
 - b. Title 40, Protection of Environment
 - c. Title 50, Wildlife and Fisheries
 2. California Code of Regulations (CCR)
 - a. Title 8, Industrial Relations/Elevators
 - b. Title 14, Natural Resources
 - c. Title 17, Public Health
 - d. Title 19, Public Safety

- e. Title 20, Public Utilities and Energy
 - f. Title 21, Public Works
 - g. Title 22, Environmental Health
 - h. Title 23, Waters
 - i. Title 24, California Building Standards Code
 - 1) Part 2, California Building Code 2010
 - 2) Part 3, California Electric Code 2010
 - 3) Part 4, California Mechanical Code 2010
 - 4) Part 5, California Plumbing Code 2010
 - 5) Part 6, California Energy Code 2010
 - 6) Part 9, California Fire Code 2010
 - 7) Part 11 California Green Building Standards Code 2010
 - 8) Part 12, California State Reference Standards 2010
 - j. Title 27 Environmental Protection 2007
3. San Joaquin Valley Air Pollution Control District Regulation #8 2004

1.3 REFERENCES

- A. Unless otherwise specified, specific references to codes, regulations, standards, manufacturers' instructions, or requirements of regulatory agencies, when used to specify requirements for materials or design elements, shall mean the latest edition of each in effect at the date of submission of bids, or the date of the Change Order (Exhibit 9) or Field Order (Exhibit 8), as applicable.

1.4 CONFLICTS

- A. Unless otherwise directed by the University's Representative, if a conflict exists between referenced regulatory requirements and the Contract Documents, the Contractor shall refer the matter to the University's Representative for further instruction.
- B. Nothing stated in this Section of the Specifications or other Sections of the Specifications, the other Contract Documents or the Bidding Documents or shown on the Drawings shall be construed as allowing Work that is not in strict compliance with all applicable Federal, State, regional, and local statutes, laws, regulations, rules, ordinances, codes and standards.

1.5 TRENCHING AND SHORING

- A. All Work shall be in full accordance, but not necessarily limited to the following codes and regulations: Titles as listed in Section 1.2 Standards and Codes above, State of California, California Code of Regulations (CCR), California Occupational Safety and Health Administration (OSHA).
 - 1. Pursuant to Labor Code 6707, the General Contractor shall include in the bid all costs incident to the provisions of adequate sheeting, shoring, bracing or equivalent method for the protection of life or limb that shall conform to applicable Federal and State safety orders.

2. Before beginning any excavation 5 feet or more in depth, the Contractor shall submit to the University's Representative a detailed Drawing showing the design of shoring, bracing, sloping, or other provisions to be made for worker protection from the hazard of caving ground during the excavation. The proposed design shall comply with the standards established by the State of California Construction Safety Orders, Title 8 and Title 24 of the California Code of Regulations (CCR). If the design varies from such shoring system standards, the Drawing shall be prepared by a registered civil or structural engineer whose name and registration number shall be indicated on the Drawing. If a dispute arises as to whether the plan must be prepared by a registered civil or structural engineer, the University's Representative's determination of the matter shall be final and conclusive on the Contractor. The cost of required engineering services shall be borne by the Contractor and shall be deemed to have been included in the Contract Sum for the Work as stated in the Agreement.
3. Neither the review nor approval of any Drawing showing the design of shoring, bracing, sloping, or other provisions for worker protection, shall relieve the Contractor from the obligation to comply with construction State of California Construction Safety Order and Title 24 of the California Code of Regulations (CCR) for the design and construction of such protective Work, and the Contractor shall indemnify the University and the University's Representative from any and all claims, liability, costs, actions and causes of action arising out of or related to the failure of such protective systems. The Contractor shall defend the University, its officers, employees, Design Professional and agents and the University's Representative in any litigation or proceeding brought with respect to the failure of such protective systems.
4. All Work including any temporary construction shall be in full compliance with the latest orders of the Division of Industrial Safety of the State of California and all codes and regulations as called for hereinafter in these specifications.

1.6 REGULATORY NOTIFICATIONS

- A. Submit all required notifications to Federal, State of California, State in which disposal facility is located if not in California, regional, and local agencies with regulatory responsibilities associated with the Work activities that are included in the Contract. All notifications shall be served in writing, in the form required by the agency requiring notification, and in a timely manner so as not to negatively impact the Project schedule. Serve notifications at least 10 working days in advance (or earlier if required by agency) of activity requiring notice. The Contractor shall serve all required notifications in writing to all governmental and quasi-government agencies having notification requirements pertaining to any portion of the Work included in the Project.
- B. Contractor shall comply with the State General Construction Activity Storm water Permit National Pollutant Discharge Eliminate System (NPDES) for the campus and comply with the University's Storm Water Pollution Prevention Plan.

1.7 NOTIFICATIONS, CERTIFICATES AND UNIFORM HAZARADOUS WASTE MANIFEST

- A. Permits
 1. Contractor will not be required to obtain a County of Merced building permit.

- B. Designated Campus Fire Marshal (DCFM)
1. Contractor shall be responsible for issuing in writing to the University's Representative the following notifications prior to starting site Work:
 - a. Hazardous Condition Notification - Hot Work (Exhibit 30): must be coordinated before starting any hot work (welding, burning, or cutting, etc.) involving use of gas or electric welding equipment. Contractor shall report to the University's Representative, at the beginning and 30 minutes prior to the end of each shift that such "hot" work takes place
 - b. Hazardous Conditions Notification-General: for the storage or use of any flammable liquid in excess of 10 gallons or in any confined area where vapors can be ignited. The General Contractor shall report to the University's Representative at the beginning and 30 minutes prior to the end of each shift that such work takes place
 - c. Hazardous Condition Notification-Special Conditions: Coordinate in advance with the University's Representative before restricting access to or blocking of any building exit or Work that will require the shutdown of building fire protection or alarm systems. The General Contractor shall report to the University's Representative at the beginning and 30 minutes prior to the end of each shift that such work takes place
 - d. At the end of the Work, the Contractor must submit Automatic Sprinkler Systems-Material and Test Certificate for Aboveground Piping and Automatic Sprinkler Systems- Material and Test Certificate for Underground Piping for approval by the University (Exhibits 20 and 21). The Automatic Sprinkler underground and aboveground will not be accepted until these certificates have been completed and submitted.
 - e. At completion of the Work, provide a fire alarm certifications NFPA 72 certificate of completion.
- C. Prior to commencing clearing, excavation and trenching, Contractor shall locate all known existing installations before proceeding with construction operations that may cause damage to such installation. Existing installations shall be kept in service where possible and damage to them shall be repaired at no additional cost to the University.
- D. Uniform Hazardous Waste Manifest: Contractor shall be responsible for coordination with the University's Representative for obtaining a Uniform Hazardous Waste Manifest prior to removal of asbestos containing materials, polychlorinated biphenyl (PCB), or other hazardous materials from the Project site. Manifest will be provided by the University's Representative. Only the University's Representative will be allowed to sign individual manifests on behalf of the Contractor / University.

1.8 CIVIL OR CRIMINAL PENALTIES OR FINES

- A. Contractor shall be liable for the payment of any and all civil or criminal penalties or fines imposed by the U.S. Fish & Wildlife Service (USFWS), U.S. Army Corps of Engineers (USACE), California Department of Fish & Game (CDFG), Central Valley Regional Water Quality Control Board (CVRWQCB) or any other applicable regulatory agency for Contractor's violations of the federal Endangered Species Act (ESA), Clean Water Act (CWA), California Endangered Species Act (CESA), Porter-Cologne Water Quality Control Act (Porter-Cologne);

any regulation promulgated to implement said statutes; the UC Merced Biological Opinion; or any applicable authorization issued by the USFWS, USACE, CDFG, CVRWQCB, or other applicable federal, state or local regulatory agency.

- B. In the event Contractor is found liable for civil actions under the abovementioned statutes, regulations, permits or authorizations, Contractor shall be responsible for the payment of any civil penalties imposed by any applicable regulatory agency. Penalties may vary according to the applicable statute, including but not limited to, penalties of up to \$50,000 per day of violation of the CWA, \$25,000 for each ESA violation, and \$15,000 per day of violation of Porter-Cologne.
- C. In the event Contractor is convicted of criminal actions under the abovementioned statutes, regulations, permits or authorizations, Contractor shall be responsible for satisfying applicable terms of imprisonment and the payment of any criminal fines imposed by the regulatory agency. Fines may vary according to the applicable statute, including but not limited to, fines of \$250,000 per day of violation of the CWA, \$50,000 for each ESA violation, and \$15,000 per day of violation of Porter-Cologne.

PART 2 - PRODUCTS (NOT USED)

PART 3 - EXECUTION (NOT USED)

END OF SECTION 01410

SECTION 01 42 13
ABBREVIATIONS, SYMBOLS & DEFINITIONS

PART 1 - GENERAL

1.1 ABBREVIATIONS

A. The following abbreviations of organizations may be used in the Contract Documents:

AA	Aluminum Association
AABC	Associated Air Balance Council
AAMA	Architectural Aluminum Manufacturers' Association
AAN	American Association of Nurserymen, Inc.
AASHTO	American Association of State Highway and Transportation Officials
ABAG	Association of Bay Area Governments
ABPA	Acoustical and Board Products Association
ABPTA	American Bearing Power Transmission Association
ACI	American Concrete Institute
ACIL	American Council of Independent Laboratories
ACPA	American Concrete Pipe Association
ADA	Americans with Disabilities Act of 1990
ADAAG	American with Disabilities Act Accessibility Guidelines
ADC	Air Diffusion Council
AFBMA	Anti-Friction Bearing Manufacturers Association
AFI	Air Filter Institute
AGA	American Gas Association
AF&PA	American Forest and Paper Association
AGC	Associated General Contractors of America
AHA	American Hardboard Association
AI	The Asphalt Institute
AIA	American Institute of Architects
AIEE	American Institute of Electrical Engineers
AIMA	Acoustical and Insulation Materials Association
AISC	American Institute of Steel Construction
AISI	American Iron and Steel Institute
AITC	American Institute of Timber Construction
ALSC	American Lumber Standards Committee
AMCA	Air Moving and Conditioning Association
ANSI	American National Standards Institute
AOAC	Association of Official Analytical Chemists
APA	American Plywood Association
API	American Petroleum Institute
AQMD	Air Quality Management District
ARI	Air-Conditioning and Refrigeration Institute
ASA	American Standards Association
ASAHC	American Society of Architectural Hardware Consultants
ASCE	American Society of Civil Engineers
ASHRAE	American Society of Heating, Refrigerating and Air-Conditioning Engineers

ASME	American Society of Mechanical Engineers Association
ASTM	American Society for Testing and Materials
AWCI	Association of Wall and Ceiling Industries
AWG	American Wire Gauge
AWI	Architectural Woodwork Institute
AWPA	American Wood-Preservers' Association
AWPB	American Wood Preservers Bureau
AWPI	American Wood Preservers Institute
AWS	American Welding Society
AWWA	American Water Works Association
BHMA	Builders Hardware Manufacturers' Association
BICSI	Building Industry Consulting Service International
BOCA	Building Officials and Code Administrators
CAC	California Administrative Code
CARB	California Air Resources Board
CBC	California Building Code
CBSC	California Building Standards Commission
CCR	California Code of Regulations
CDA	Copper Development Association, Inc.
CDFG	California Department Fish and Game
CE	Corps of Engineers (U.S. Dept. of the Army)
CEC	California Energy Commission
CEQA	California Environmental Quality Act
CERCLA	Comprehensive Environmental Response and Cleanup Liability Act
CESO	California Elevator Safety Order
CFC	
CGA	Compressed Gas Association
CISPI	Cast Iron Soil Pipe Institute
CLFMI	Chain Link Fence Manufacturer's Institute
CLPA	California Lathing and Plastering Association
CMC	California Mechanical Code
CMM	State of California, Business, Transportation and Housing Agency, Department of Transportation "Materials Manual"
COSHA	California Occupational Safety and Health Act
CPC	California Plumbing Code
CPSC	Consumer Product Safety Commission
CRI	Carpet and Rug Institute
CRSI	Concrete Reinforcing Steel Institute
CS	Commercial Standards of NBS (U.S. Dept. of Commerce)
CSS	State of California, Business, Transportation and Housing Agency, Department of Transportation "Standard Specifications"
CTI	Cooling Tower Institute
CVRWQCB	Central Valley Regional Water Quality Control Board
DCFM	Designated Campus Fire Marshal
DHI	Door & Hardware Institute
DHS	California Department of Health Services
DSA	Division of State Architect
DSA/AC	Division of State Architect, Access Compliance Section

EIA	Electronic Industrial Alliance
EPA	Environmental Protection Agency
ESO	Electrical Safety Orders of Division of Industrial Safety, Title 8, CAC
ETL	Electrical Testing Laboratories
FCC	Federal Communications Commission
FFDA	Federal Food and Drug Administration
FGMA	Flat Glass Marketing Association
FIA	Factory Insurance Association
FM	Factory Mutual System, Factory Mutual Engineering Corporation
FS	Federal Specifications
FSC	Forest Stewardship Council
GA	Gypsum Association
GFI	Ground Fault Interrupter
HCP	Habitat Conservation Plan
HEPA	High Efficiency Particulate Air
HI	Hydronics Institute
HMI	Hoists Manufacturers Institute
HMMA	Hollow Metal Manufacturers Association
HPMA	Hardwood Plywood Manufacturers Association
IAPMO	International Association of Plumbing and Mechanical Officials
IAQ	Indoor Air Quality
IBEW	International Brotherhood of Electrical Workers
IBR	Institute of Boiler and Radiator Manufacturers
ICBO	International Conference of Building Officials
ICC	
ICEA	Insulated Cable Engineering Association
IEC	International Electrotechnical Commission
IEQ	Indoor Environmental Quality
IEEE	Institute of Electrical and Electronics Engineers
IES	Illuminating Engineering Society of North America
IGCC	Insulating Glass Certification Council
IPCEA	Insulated Power Cable Engineers' Association
ISA	Instrument Society of America
ISO	International Standards Organization
ITU	International Telecommunications Union
LEED®	Leadership in Energy & Environmental Design
LIA	Lead Industries Association
MBMA	Metal Building Manufacturer's Association
MIA	Marble Institute of America
MID	Merced Irrigation District
MIL	U.S. Government, Military Specification
MLSFA	Metal Lath/Steel Framing Association
MM	State of California, Business, Transportation and Housing Agency, Department of Transportation "Materials Manual"
MSS	Manufacturers Standardization Society of Valves and Fittings Industry
NAAB	National Association of Air Balance
NAAMM	The National Association of Architectural Metal Manufacturers
NACE	National Association of Corrosion Engineers

NBFU	National Board of Fire Underwriters
NBGQA	National Building Granite Quarries Association, Inc.
NBHA	National Builders' Hardware Association
NBS	National Bureau of Standards
NCCP	National Communities Conservation Plan
NCMA	National Concrete Masonry Association
NCPWB	National Certified Pipe Welding Bureau
NEBB	National Environmental Balancing Bureau
NECA	National Electrical Contractors Association
NEMA	National Electrical Manufacturers Association
NEPA	National Environmental Protection Act
NETA	National Electrical Testing Association
NFPA	National Fire Protection Association
NHLA	National Hardwood Lumber Association
NIOSH	National Institute of Occupational Safety and Health
NPA	National Particleboard Association
NPDES	National Pollutant Discharge Eliminate System
NRC	Noise Reduction Coefficient
NRCA	National Roofing Contractors Association
NRMCA	National Ready Mixed Concrete Association
NSF	National Sanitation Foundation
NWMA	National Woodwork Manufacturers Association, Inc.
NWWDA	National Wood Window and Door Association
OSHA	Office of Safety and Health Act
OSHPD	Office of Statewide Health Planning and Development
PCA	Portland Cement Association
PCB	Polychlorinated Biphenyl
PCI	Precast/Prestressed Concrete Institute
PDI	Plumbing and Drainage Institute
PI	Perlite Institute
PS	Product Standard of United States Department of Commerce
RCRA	Resource Conservation & Recovery Act
RCSC	Research Council on Structural Connection
RFCI	Resilient Floor Covering Institute
RIS	Redwood Inspection Service
RUS	U.S. Department of Agriculture, Rural Utilities Service
SJVAPCD	San Joaquin Valley Air Pollution Control District
SAE	Society of Automotive Engineers
SBC	State Building Code
SBS	State Building Standards Electrical Code, Title 24, Part 3
SCS	Scientific Certification Systems
SDI	Steel Door Institute
SFM	State of California, Office of State Fire Marshal
SIGMA	Sealed Insulating Glass Manufacturers Association
SJI	Steel Joist Institute
SMACNA	Sheet Metal & Air Conditioning Contractors' National Association, Inc.
SPIB	Southern Pine Inspection Bureau (Grading Rules)
SPR	Simplified Practice Recommendation

SSPC	Society for Protective Coatings
STC	Sound Transmission Coefficient
SWI	Sealant and Waterproofers Institute
SWPPP	Storm Water Pollution Prevention Plan
TCA	Tile Council of America, Inc.
TIA	Telecommunications Industry Association
UBC	Uniform Building Code
UCM	University of California Merced
UCMFM	University of California Merced Facilities Management
UFAS	Uniform Federal Accessibility Standards
UHMW	Ultra-High Molecular Weight
UL	Underwriters' Laboratories, Inc.
USA	Underground Service Alert
USDA	United States Department of Agriculture
USFWS	United States Fish & Wildlife Service
USGBC	United States Green Building Council
USS	United States Standards
USSG	United States Steel Gauge
WAPA	Western Area Power Authority
WCLIB	West Coast Lumber Inspection Bureau
WH	Warnock Hersey
WIC	Woodwork Institute of California
WLPDIA	Western Lath/Plaster/Drywall Industries Association
WRSI	Western Concrete Reinforcing Steel Institute
WWPA	Western Wood Products Association
WWPOA	Western Wood Preserving Operators Association
WWTP	Waste Water Treatment Plant

B. Additional abbreviations, used on the Drawings, are listed thereon.

1.2 SYMBOLS

A. Symbols, used only on the Drawings, are shown thereon.

1.3 DEFINITIONS

A. The following terms, when used on the Drawings or in the Specifications, shall have the following meanings:

1. AS DIRECTED - "As directed by the University's Representative."
2. AS REQUIRED - "As required by Applicable Code Requirements; by good building practice; by the condition prevailing; by the Contract."
3. AS SELECTED - "As selected by the University's Representative."
4. BY OTHERS - Work on this Project that is outside the scope of Work to be performed by the CM/Contractor under this Contract, but that will be performed by the University, Separate Contractors, or other means.
5. EQUAL - Of same quality, appearance, and utility to that specified, as determined by the University's Representative. The CM/Contractor bears the burden of proof of quality.

6. FABRICATED - Items specifically assembled or made out of selected materials to meet individual design requirements.
7. FURNISH - "Supply only, not install (unless required to be provided or installed elsewhere in the Contract Documents)."
8. INSTALL - "Install or apply only, not furnish."
9. MANUFACTURED – Applies to standard units usually mass-produced.
10. OFF SITE - Outside the Work area as shown on the Drawings or the property lines.
11. PROJECT SITE - Geographical location of the Project.
12. PROVIDE - "Furnish and install."
13. SHOWN - "As indicated on the Drawings."
14. SPECIFIED - "As written in the Contract Documents."
15. SUBMIT - "Submit to University's Representative."
16. OFCI - UNIVERSITY-FURNISHED, CONTRACTOR INSTALLED - "To be furnished by University and installed by CM/Contractor as part of the Work. Scope of work includes receipt, off-loading, inspection, on-site storage of material and protection after installation until acceptance."

PART 2 - PRODUCTS (NOT USED)

PART 3 - EXECUTION (NOT USED)

END OF SECTION 01 42 13

**SECTION 01 45 00
QUALITY CONTROL**

PART 1 - GENERAL

1.1 DEFINITIONS

- A. The term "University's Testing Laboratory" means a testing laboratory retained and paid for by University for the purpose of reviewing material and product reports and performing other services as determined by the University.
- B. The term "CM/Contractor's Testing Laboratory" means a testing laboratory retained and paid for by CM/Contractor to perform the testing services required by the Contract Documents. CM/Contractor's Testing Laboratory shall be an organization other than University's Testing Laboratory and shall be acceptable to the University's Representative. It may be a commercial testing organization, the testing laboratory of a trade association, the certified laboratory of a supplier or manufacturer, CM/Contractor's own forces, or other organization. CM/Contractor's Testing Laboratory shall have performed testing of the type specified for at least 5 years.
- C. The term "Geotechnical Engineer" means an engineer retained and paid for by the University for the purpose of performing geotechnical inspection, testing, and observation functions specified by the University.

1.2 CM/CONTRACTOR'S RESPONSIBILITIES REGARDING UNIVERSITY'S TESTING LABORATORY

- A. Secure and deliver to University's Testing Laboratory adequate quantities of representative samples of materials proposed for use as specified.
- B. Submit a copy of the preliminary design mixes proposed to be used for concrete and other materials that require review by University's Testing Laboratory to the University Representative. University Representative will submit the copy to the University's Testing Laboratory for review.
- C. Submit copies of product test reports as specified.
- D. Furnish incidental labor and facilities:
 - 1. To provide University's Testing Laboratory access to the Work to be tested.
 - 2. To obtain and handle samples at the Project site or at the source of the product to be tested.
 - 3. To facilitate inspections and tests.
 - 4. For storage and curing of test samples.
- E. Provide a minimum of seventy-two (72) hour notice to University's Representative to allow for University's Testing Laboratory assignment of personnel and scheduling of tests.
- F. When material or work to be tested or inspected is not available for testing or inspection, even though notice has been given under Subsection 1.2.E above, CM/Contractor shall

reimburse University for University's Testing Laboratory personnel and travel expenses incurred.

1.3 TESTS AND INSPECTIONS

- A. Tests, inspections, and acceptance of portions of the Work required by the Contract Documents or by Applicable Code Requirements shall be made at the appropriate times. Except as otherwise provided, CM/Contractor shall make arrangements for such tests, inspections, and acceptances with CM/Contractor's Testing Laboratory. CM/Contractor shall give the University's Representative a minimum of forty-eight (48) hours written notice of when and where tests and inspections are to be made.
- B. If such procedures for testing, inspection, or acceptance reveal failure of the portions of the Work to comply with requirements established by the Contract Documents, CM/Contractor shall bear all costs made necessary by such failure including those of repeated procedures and compensation for the University's Representative's services and expenses.
- C. If the University's Representative is to observe tests, inspections, or make acceptances required by the Contract Documents, University's Representative will do so promptly and, where practicable, at the normal place of testing.
- D. Tests or inspections conducted pursuant to the Contract Documents shall be made promptly to avoid unreasonable delay in the Work.
- E. Certain portions of the Work will be tested and/or inspected at various stages. Nothing in any prior acceptance or satisfactory test result shall govern, if at any subsequent time the Work, or portion thereof, is found not to conform to the requirements of the Contract Documents.

1.4 ADDITIONAL TESTING AND INSPECTION

- A. If initial tests or inspections made by University's Testing Laboratory or Geotechnical Engineer reveal that any portion of the Work does not comply with the Contract Documents, or if the University's Representative determines that any portion of the Work requires additional testing or inspection, additional tests and inspections shall be made as directed.
 - 1. If such additional tests or inspections establish that such portion of the Work complies with the Contract Documents, all costs of such additional tests or inspections shall be paid by the University.
 - 2. If such additional tests or inspections establish that such portion of the Work fails to comply with the Contract Documents, all costs of such additional tests and inspections, and all other costs resulting from such failure, including compensation for the University's Representative and the University's consultants, shall be deducted from the Contract Sum.

1.5 TEST REPORTS

- A. University's Testing Laboratory and General Contractor's Testing Laboratory shall submit 1 copy of all reports to University's Representative, indicating observations and results of tests and indicating compliance or non-compliance with the Contract Documents.
- B. The University's Representative shall distribute to the CM/Contractor one copy of the reports from the University's Testing Laboratory.
- C. The number of copies for the CM/Contractor and supplier being tested will be determined upon commencement of the Contract.

1.6 CLOSING IN UNINSPECTED WORK

- A. Do not allow or cause Work to be covered or enclosed before it has been inspected and approved by the University's Representative. Should any Work be enclosed or covered before it has been approved, it shall be uncovered, inspected, approved or repaired, and covered. Make all repairs necessary to restore Work of others to the condition in which it was found at time of cutting, at no additional cost to the University.

1.7 GEOTECHNICAL ENGINEER

- A. All excavation, filling, and compaction shall be subject to inspection, observation, and testing by Geotechnical Engineer. The University will retain and pay expenses of the Geotechnical Engineer to perform the inspection, testing, and observation functions described in this Section, except that the costs of any additional testing or inspection made necessary by inadequate compaction, replacement of unacceptable material or other Work not complying with the Contract Documents shall be borne by the CM/Contractor and may be deducted from the Contract Sum. The Geotechnical Engineer shall communicate with the University's Representative who will relay any appropriate instructions to the CM/Contractor.
- B. Source Quality Control: Geotechnical Engineer will sample and test fill material from the source designated by the CM/Contractor. CM/Contractor shall pay for the Geotechnical Engineer's transportation expenses, if the source is more than 50 miles from the Project site.

1.8 JOB CONDITIONS

- A. CM/Contractor shall visit the Project site to determine the existing conditions, nature of materials to be encountered and other facts concerning or affecting the Work to be performed under this Contract.
- B. The records of investigation of soil or subsurface conditions and logs of test borings that are made available by the University are not part of the Contract and are solely for the convenience of the Bidder or CM/Contractor. It is expressly understood and agreed that the University assumes no responsibility whatsoever in respect to the sufficiency or accuracy of the investigation thus made, the records thereof, or of the interpretations set forth therein, and there is no warranty or guaranty, either express or implied, that the conditions indicated by such investigations or records are representative of those existing throughout such areas or any part thereof, or that unanticipated for developments may not

occur, or that materials other than, or in proportions different from those indicated, may not be encountered.

- C. The availability or use of the records of investigations of soil or subsurface conditions and/or logs of test borings shall not be construed as a waiver of the CM/Contractor's duty to examine the Project site of the Work contemplated. CM/Contractor is cautioned to make such independent investigations and examinations as necessary to satisfy the CM/Contractor of subsurface conditions to be encountered in the performance of the Work.
- D. The records of investigations will not relieve CM/Contractor from the risk of unanticipated soil or subsurface conditions or from properly fulfilling the terms of the Contract at the Contract Sum.
- E. CM/Contractor shall promptly, and before such condition is disturbed, notify the University's Representative in writing if soil or subsurface conditions are encountered which require, in the opinion of the University's Representative, design details which differ from those design details shown in the Contract Documents and the University's Representative finds that such revised, design details will cause an increase or decrease in the cost of, or the time required for performance of the Contract, the University's Representative will, after approval by the University, modify the Contract terms in writing to provide for the change in design details and to provide for an adjustment in cost and/or time of performance as permitted in the General Conditions.

1.9 RESPONSIBILITY FOR ACCURACY OF SITE DATA

- A. Upon application to the University to do so, the CM/Contractor will be permitted to enter the Project site to put down test holes or trenches to determine the conditions for construction prior to bidding, and subject to compliance with the requirements of Division 1. Such test holes or trenches shall be located at least 10 feet clear of any existing foundations, and/or any existing trees, utilities, or other improvements. Test holes shall be backfilled with granular backfill as specified. The test holes shall be kept full of water during backfilling; the backfill shall be hand shoveled into the hole so that it is completely dispersed and "puddled" as placed. Drill cuttings shall be neatly piled over the hole after backfilling. Material to be excavated is assumed to be earth or other materials that can be removed by power earth moving equipment, including rippers.

PART 2 - PRODUCTS (NOT USED)

PART 3 - EXECUTION (NOT USED)

END OF SECTION 01 45 00

SECTION 01 51 00
TEMPORARY UTILITIES
AS IT APPLIES

PART 1 - GENERAL

1.1 REQUIREMENTS

- A. Contractor shall provide and maintain temporary utilities for construction operations and related necessary temporary structures. Remove them when they are no longer needed.
- B. Contractor shall pay for connections/disconnections of all temporary utilities; e.g., gas, water, power, and telephone.
- C. Contractor shall pay for connections for water and electricity to Project site sources.
- D. University does not guarantee amounts of water and electricity available from existing sources, nor will the University be responsible for interruptions in service.
- E. Contractor shall maintain and operate systems to provide continuous service.
- F. Contractor shall modify and extend systems as required.
- G. Materials may be new or used, but shall be adequate for the required purposes. Their use and methods of installation shall not create unsafe conditions or violate requirements of Applicable Codes Requirements.

1.2 REMOVAL AND RECONDITIONING

- A. Contractor shall remove all temporary services installed as a requirement of these Contract Documents. Restore utilities to their original condition at the completion of Work.
- B. Contractor shall legally and properly dispose of all debris resulting from removal and reconditioning operations.
- C. Contractor shall patch and repair building elements as required by temporary utility removals.

1.3 REQUIREMENTS OF REGULATORY AGENCIES

- A. Contractor shall install and use temporary utilities in accordance with latest version of the following:
 - 1. California Electrical Code.
 - 2. Federal, State, and local codes and regulations.
 - 3. Utility company requirements.

1.4 TEMPORARY ELECTRICITY

- A. If adequate spare power source is available nearby, Contractor may coordinate for such power for construction. University will not provide electricity free of charge. Contractor

shall meter temporary electricity and will be charged based on average rates.

1.5 TEMPORARY FIRE PROTECTION

- A. Contractor shall conform to the rules, regulations, and instructions of the University and the Local Department and such agencies having jurisdiction or identified by the University's Representative. Contractor shall:
1. Ensure that no burning shall be done on Project site.
 2. Provide and maintain fire protection equipment including extinguishers, fire hoses, and other equipment as necessary for proper fire protection during the course of the Work.
 3. Use fire protection equipment only for extinguishing fires.
 4. Locate fire extinguishers in field offices, storage sheds, tool houses, other temporary buildings, and throughout the Project site.
- B. In the area under construction demolition, Contractor will provide at least 1 multi-purpose dry chemical fire extinguisher for each 3,000-square feet of building floor area. Locate fire extinguishers so that a person never has to walk more than 75 feet to obtain one. Fire extinguisher minimum size must be 4A:20BC (10 pound ABC). Use fire protection equipment only for fighting fires. Any additional fire extinguishers required for your scope of work are to be provided by Contractor.
- C. Contractor shall assigned a qualified person with authority to maintain fire protection equipment, institute fire prevention measures, be a liaison with the University's Representative, Local Fire Department and such agencies having jurisdiction or identified by the University's Representative, and direct the prompt removal of combustible and waste materials from the Project site. Prior to start of Work, Contractor shall organize a mandatory safety meeting. The attendees at this meeting shall at a minimum include the University's Representative, a representative of the Local Fire Department, the Contractor's Project Site Superintendent and the Contractor's Fire Liaison.
- D. Contractor shall instruct all subcontractors in the site fire prevention measures, the location of fire extinguishers and the procedures for dealing with fire on site.
- E. Call 9-1-1 and pull fire alarm box when applicable, for any emergency. Report the exact location (building name and street intersection) and nature of the emergency. Contractor is responsible for and will be billed for fire response charges (actual cost of personnel and equipment) for any false alarm and needless call.
- F. Refer to Section 01 41 00 Regulatory Requirements for permits required.
- G. Vehicles or storage of materials on Project site must not obstruct, block or damage or render useless any fire hydrants, fire department connection, fire alarm box or fire access roadway. Any necessary road closures or disruption to utilities shall be requested through the University's Representative as stated in Section 01 35 00 Special Requirements.
- ~~H. Do not tamper with or work on any fire alarm or fire protection system without first gaining authorization from the University's Representative. System shutdown requests~~

~~shall require a minimum of 48 hours advance notice. Contact University's Representative for any such requests.~~

1.6 TEMPORARY HEAT, VENTILATION AND AIR CONDITIONING

- ~~A. Contractor shall provide temporary heat and ventilation as required by the Instructions to Bidders and as required to maintain adequate environmental conditions to meet specified minimum conditions for installation of materials; and to protect equipment, materials, and finishes from damage due to temperature or humidity for all work. The use of temporary heating appliances will require a Hazardous Condition Permit as specified in Section 01 41 00 Regulatory Requirements.~~
- ~~B. Contractor shall provide adequate forced ventilation of enclosed areas to cure installed materials, to prevent excessive humidity, and to prevent hazardous accumulations of dust, fumes, vapors, or gases for their own work.~~

1.7 TEMPORARY SANITARY FACILITIES

- A. Portable Chemical Toilets and maintenance will be provided by Contractor.
- B. Permanent toilet facilities within an existing building shall not be used without written authorization of the University.

1.8 TEMPORARY TELEPHONE SERVICE

- A. Contractor shall provide a mobile phone on-site at all times for effective University's Representative communications with the Contractors field personnel.

1.9 TEMPORARY WATER

- A. University will not provide water free of charge. Contractor shall meter temporary water and will be charged based on average rates.
- B. Water may be taken from local systems in such quantities and at such times as they are available. If this is done, Contractor shall provide all equipment, including metering, connections, and other materials necessary for extending the utility lines to where they will be used. Coordinate the installation with University's Representative. Contractor shall pay for connections and removal of connections to the local water and power mains.
- C. If water is obtained from a City fire hydrant, the hydrant valve shall not be used as a control valve. Use hydrant wrench; do not use pipe wrench. Contractor shall provide all valving necessary to control the flow of water.
- D. Contractor shall:
1. Use a reduced pressure backflow preventer shall be used at any connection to University's system, including fire hydrants.
 2. Install according to California Administrative Code, Title 17, Section 7603(c), and test immediately after installation by a certified tester in accordance with Title 17, CAC, Section 7605(d).

3. Install piping with taps located so that water is available throughout the Project site by the use of hoses. Protect piping and fittings against freezing.
4. Provide water for human consumption in accordance with the regulatory requirements for potable water.

PART 2 - PRODUCTS (NOT USED)

PART 3 - EXECUTION (NOT USED)

END OF SECTION 01 51 00

SECTION 01 56 00
TEMPORARY BARRIERS AND ENCLOSURES

PART 1 - GENERAL

1.1 TEMPORARY FACILITIES

- A. Contractor shall provide and maintain the following temporary facilities as required for prosecution of the Contract:
 - 1. All scaffolding, staging, runways, and similar equipment necessary to complete work is to be provided by Contractor.
 - 2. Temporary rigging, rubbish chutes, ladders between floors and similar equipment shall be provided by Contractor
 - 3. Barricades, lights and similar safety precautions shall be provided by the Contractor.
 - 4. All materials and equipment required to safely accomplish Work under this Section shall be in conformance with requirements of California Occupational Safety and Health act (OSHA), Chapter 5 of CalTrans Traffic Manual and other State and Federal Codes and regulations where applicable.
- B. Codes: All temporary Work and facilities shall conform to the above requirements that pertain to operation, safety and fire hazard.
- C. Removal: Upon completion of the Work, and before the final payment, the responsible Contractor shall remove all temporary Work and facilities to put the Project site in the condition required by the Contract Documents with no additional cost to the University.

1.2 TEMPORARY PROJECT CONSTRUCTION FENCE

- A. No Contractor shall place any signs, advertisements, notices, or graphic materials on construction fencing that have not been approved in advance by University's Representative.
- B. Fencing shall be provided and maintained by Contractor.
- C. Contractor is responsible for any damage caused by Contractor's Operations.

PART 2 - PRODUCTS (NOT USED)

PART 3 - EXECUTION (NOT USED)

END OF SECTION 01 56 00

SECTION 01 57 23
STORM WATER POLLUTION PREVENTION

PART 1 - GENERAL

1.1 SCOPE

- A. Discharge of pollutants (any substance, material, or waste other than clear, uncontaminated storm water) from the project into the storm drain system is strictly prohibited by the Central Valley Regional Water Quality Control Board's (CVRWQCB) Water Quality Control Plan (Basin Plan).
- B. Contractor to provide all material, labor, and equipment for installation, implementation, and maintenance of all surface-water pollution prevention measures. This work includes the following:
 - 1. Furnishing, placing, and installing effective measures for preventing runoff of soil, silts, gravel, hazardous chemicals or other materials prohibited by the CVRWQCB from entering the storm water drainage system.
 - 2. Management of on-site construction materials in such a manner as to prevent said materials from contacting storm water or wash water and running off into the storm drain system.
 - 3. Complying with applicable standards and regulations specified herein.
 - 4. Maintain 1 copy of the most current revised Storm Water Pollution Protection Plan (SWPPP) at the Contractor's work site.
 - 5. Review any changes in the SWPPP plan each week at the weekly meetings with University's Representative and others. At each weekly meeting, the Contractor shall submit a numbered checklist of the current status of each prevention measure on the job site.
- C. In this section, the term "storm drain system" shall include storm water conduits, storm drain inlets and other storm drain structures, street gutters, channels, ditches, and the Fairfield Canal and Little Lake.
- D. Sanitary sewer discharge regulations are intended to provide protection of the sanitary sewer system and the University's or local Waste Water Treatment Plant (WWTP). In this section, "sanitary sewer" shall include any sanitary sewer manhole, clean out, sewer laterals or other connection to the WWTP.
- E. Contractor shall have storm water pollution prevention measures in place and conduct inspections year-round. It is the responsibility of the Contractor to be prepared for a rain event in the non-rainy season, and to be aware of weather predictions. The University is not responsible for informing the Contractor of rain predictions.
- F. Sanitary sewer blockages can result in a back-up and discharge to the storm drain system. Contractor shall immediately notify the University's Representative if they become aware of a clogged sanitary sewer associated with the Project.

- G. Contractor shall not allow any non-storm water from the Project to enter the storm drain system. Examples of non-storm water include water used for dust suppression, pipe flushing and testing, and domestic supply water used to wash streets, painting and drywall equipment, vehicles, or other uses.
- H. Water resulting from de-watering an excavation may be discharged to a storm drain only if it is free of pollutants, including sediment. Contractor shall use methods such as a settling basin or filter to ensure that dewatering discharges are free of pollutants.

1.2 REGULATIONS AND STANDARDS

- A. Contractor shall comply with the following applicable regulations, including all applicable amendments:
 - 1. Clean Water Act, United States Environmental Protection Agency, and Porter-Cologne Water Quality Act, State of California.
 - 2. Central Valley Regional Water Quality Control Board's Basin Plan, 1998 Edition.
 - 3. Waste Discharge Requirements Order No. 2010-0014-DWQ (National Pollutant Discharge Elimination System (NPDES) Permit No. CAS000002) These Orders are referred to as the General Permit.
 - 4. NPDES Phase II General Municipal Permit requirements.
- B. Contractor shall comply with the following standards and guidelines on storm drain pollution prevention:
 - 1. California Stormwater Quality Association Handbooks – Construction, Municipal, Industrial and Commercial, and New Development and Redevelopment. These documents can be viewed and downloaded from the Association's website at <http://www.cabmphandbooks.org>.

1.3 SUBMITTALS

- A. Submittals shall comply with requirements specified in Section 01 33 23 Shop Drawings, Product Data and Samples.
- B. Submit a New Construction Project Information Form (Exhibit 19) to University's Representative. This form is required for compliance with the campus-wide permit with the CVRWQCB for discharges of storm water associated with construction activities.
- C. Review the University's Storm Water Pollution Prevention Plan (SWPPP) prior to ground breaking. The SWPPP contains all required elements specified in the General Permit using the SWPPP Template in Appendix B of the California Stormwater Quality Association – Stormwater Best Management Practice Handbook for Construction. This template can be downloaded from the California Stormwater Quality Association website at <http://www.cabmphandbooks.org/Construction.asp>. The SWPPP has been developed and revised as necessary to meet the following objectives:
 - 1. To identify pollutant sources that may affect the quality of storm water discharges associated with construction activity from the construction site.

2. To identify non-storm water discharges.
3. To identify, construct, and implement storm water pollution prevention measures (Best Management Practices, or BMPs) to reduce or eliminate pollutants in storm water discharges from the construction site, both during construction and after construction is completed.
4. To develop a maintenance schedule for BMPs installed during construction designed to reduce or eliminate pollutants after construction is completed (post-construction BMPs).
5. Contractor shall notify the University whenever there is a change in construction, operations or site conditions that may affect the discharge of pollutants to surface waters so that the SWPPP can be amended. All amendments should be dated and directly attached to the SWPPP.
6. The SWPPP shall include a site map and site-specific written plans that describes pollution sources for the construction activity and the methods that will be used for erosion and sediment control, hazardous materials management, and any other construction activity that are sources of pollution. The list of topics to be covered in the plan are included in Part 3 Execution of this Section.

- D. Site work shall not commence until the SWPPP has been reviewed and accepted by the University's Representative.

PART 2 - PRODUCTS

2.1 MATERIALS

- A. General: Provide materials as required for execution of the Work.

PART 3 - EXECUTION

3.1 GENERAL

- A. The Contractor shall provide qualified personnel that will implement the University's SWPPP. The Contractor will choose the best available performance-based technology and methods to prevent storm water pollution for construction site activity. The method(s) chosen shall be appropriate for each specific site condition.
- B. The University will provide a Qualified SWPPP Practitioner (QSP) to make all required inspections and complete inspection checklist, using a form provided by the State Water Board or Regional Water Board. Contractor shall make all necessary corrections or changes noted on the inspection checklist.

3.2 SWPPP TOPICS

- A. Following are topics addressed in the SWPPP:
1. Introduction/Site Description:

- a. The SWPPP shall include basic information about the project including: size of site, type of construction, location of site, project start date and estimated completion date. The site description shall be updated to reflect changes in conditions which may reflect.
2. Maps:
 - a. The General Permit has specific map requirements, including a topographic map showing the location of nearby surface water bodies and the discharge location(s) for the site. A detailed site map is also required, which shall identify areas of soil disturbance, location of surface water bodies, areas of existing surface vegetation, location of sediment or pollutant control measures, site drainage patterns, areas used for storage of soils, waste, or materials, vehicle and equipment parking or service areas, existing paved areas and location of post-construction controls. The maps shall be updated as needed to reflect changes as the project progresses. The approved map and plan shall be kept onsite for reference by the Contractor, University's Representative or governmental agencies.
3. Description of Site and Soil Types:
 - a. Include the following estimates:
 - 1) The size of the construction site (in acres) ;
 - 2) The runoff coefficient of the site before and after construction;
 - 3) The percentage of the area of construction that is impervious before and after construction) .
4. Pollutant Sources:
 - a. List and describe pollutants that are likely to be present in storm water discharges from the site, such as sediment, waste materials, concrete, etc. Describe the locations of storage or use of such materials and the measures to prevent pollution.
5. Toxic Materials:
 - a. Describe all toxic materials that will be used during construction, such as adhesives, paint, petroleum products, pesticides, and vehicle fluids. Describe the locations of storage or use of such materials and the measures to prevent pollution.
6. Erosion and Sediment Control:
 - a. Provide a description of erosion and sediment control measures that will be used on the site, and correlate the description with the site map. Areas requiring erosion control measures are exposed soil, such as stockpiles, bare soil, sloped soil, and any area of disturbed soil. Erosion control measures include paving, tarp placement, soil blankets, mulching, seeding, hydro-mulching, and spreading straw. Sediment control measures include drain inlet protection, filter fabric, geo-textile silt fencing, gravel placement, gravel or sand bag placement, and straw wattle placement. This list is not all inclusive and the Contractor should refer to the resources listed in this section to identify the best measures for the project. Describe measures to reduce the tracking of sediment from the site. Describe waste disposal practices and methods to prevent waste materials from polluting storm water. Indicate the location of concrete washout areas. Both erosion and sediment control practices are designed to be implemented as an integrated system of pollution control. Without

erosion controls, sediment controls are easily overwhelmed and will not prevent pollution.

7. Non-Storm Water Management:
 - a. Describe all non-storm water discharges that may occur on site. Examples of non-storm water discharges include irrigation runoff, street cleaning, spills, or leakage from storage tanks. Non-storm water discharges should be eliminated or reduced to the extent feasible. Discharges from dewatering are allowed only if they are free of pollutants, including sediment.
8. Maintenance, Inspection and Repair of Controls:
 - a. Structural pollution controls require ongoing inspection, maintenance and repair. Contractor shall maintain all pollution control measures to achieve compliance with the SWPPP and General Permit. Describe procedures for responding to failure of any structural controls and indicate the persons responsible for inspection, maintenance and repair.
9. Spill Prevention and Control:
 - a. Measures to prevent, control and respond to spills shall be described in the SWPPP. Contractor shall take precautions to prevent accidental spills of pollutants, including hazardous materials brought onsite by the Contractor. However, in the event of a spill, the Contractor shall be responsible for the following:
 - 1) Immediately contain and prevent leaks and spills of prohibited pollutants from entering the storm drain system. Clean up the spill and label the contained material. Store the container in a safe place and contact the University's Representative prior to disposal of the waste by the Contractor. Contractor shall keep a spill kit on site at all times for this purpose. The Contractor shall also keep a sampling kit, with the spill kit. At a minimum, three appropriate vials for sampling.
 - 2) Contractor shall comply with all federal, state, and local hazardous waste requirements. Ensure that no spilled materials are washed into the streets, gutters, storm drains, or creeks.
 - 3) Report any hazardous or unknown material spills immediately to the University's Representative and the University of California, Merced Office of Environment, Health and Safety. If a spill occurs after hours or on a weekend, call (209) 658-8487 and Merced County Department of Public Health, Division of Environmental Health at (209) 381-1090.
10. Post-Construction Stormwater Management
 - a. Describe all the control practices to reduce pollutants in storm water discharges after the construction activities are completed at the site. Post construction BMPs include: minimizing land disturbance, minimizing impervious surfaces, treatment of storm water runoff using filtration, use of efficient irrigation systems, and planting to reduce erodable surfaces.
11. Personnel:
 - a. Identify and describe the training of the personnel responsible for the implementation and monitoring of the SWPPP and BMPs. Documentation of

training shall be available upon the request of the University's Representative or a regulatory agency.

12. Notification List:

- a. Provide the company's name, address and telephone number, along with a contact person's name and telephone number for everyone responsible for implementation of the SWPPP. The Contractor shall inform all subcontractors (if any) of the water pollution prevention requirements contained in this specification and the site-specific SWPPP and include appropriate subcontract provisions to ensure that these requirements are met.

13. Monitoring and Reporting:

- a. The SWPPP shall describe the monitoring program to ensure compliance with the General Permit. The monitoring plan shall include site inspections and the University's QSP shall conduct inspections of the construction site weekly, prior to anticipated storm events, during extended storm events, and after actual storm events to identify areas contributing to a discharge of storm water associated with construction activity. The name(s) and contact number(s) of the assigned QSP inspection personnel shall be listed in the SWPPP. Weekly and pre-storm inspections are to ensure that BMPs are properly installed and maintained; post-storm inspections are to assure that the BMPs have functioned adequately. The Contractor should also be inspecting BMPs regularly, prior to and after storm events to insure they are installed and maintained. During extended storm events, inspections by the QSP shall be required each 24-hour period. BMPs shall be evaluated for adequacy and proper implementation and whether additional BMPs are required in accordance with the terms of the General Permit.
- b. Inspections by the QSP must be documented and the records maintained onsite for review by the University's Representative or regulatory agencies. If instances of non-compliance with the General Permit are identified, the Contractor shall notify the University's Representative immediately. Corrective measures should be implemented immediately following discovery of an exceedance of water quality standards or other instance of non-compliance.

3.3 ENVIRONMENTAL ENFORCEMENT

- A. The CVRWQCB has authority to enforce, through codified regulations, any portions of this Section that may violate applicable regulations. Agency enforcement may include but is not limited to: citations, orders to abate, bills for cleanup costs and administration, civil suits, and/or criminal charges. Contract compliance action by the University shall not be construed to void or suspend any enforcement actions by these or other regulatory agencies.
- B. Contractor shall notify the University's Representative within 24 hours after issuance of any citation(s) issued by any regulatory agency and shall be responsible for all fines and costs necessary to correct the conditions listed in the citation(s) to include all legal fees and University expenses.

END OF SECTION 01351

SECTION 01 60 00
PRODUCT REQUIREMENTS

PART 1 - GENERAL

1.1 REQUIREMENTS

- A. All material and equipment incorporated in the Work shall be:
 - 1. New.
 - 2. In a condition acceptable to the University's Representative.
 - 3. Suitable for intended use.
 - 4. Clean, dry, and undamaged.

1.2 TRANSPORTATION AND HANDLING

- A. Arrange for delivery of materials and equipment to minimize length of on site storage prior to installation.
- B. All common carrier deliveries shall be marked for the Contractor. Identify location of Project site by Project name, street address, etc.
- C. University will not receive deliveries on behalf of the Contractor.
- D. Deliver manufactured products and materials in their original unbroken containers or bundles, clearly labeled with manufacturer's name, brand, and grade seal or model number and labels intact until time of use.
- E. Handle materials and equipment in a manner to avoid damage to products and their finishes.
- F. Promptly remove damaged or defective products from the Project site and replace at no additional cost to the University.

1.3 STORAGE AND PROTECTION

- A. Other than Project site, storage space may not be available.
- B. Store manufactured products in accordance with manufacturers' instructions and with seals and labels intact and legible.
 - 1. Store products subject to damage by the elements in weather tight enclosures.
 - 2. Maintain temperature and humidity in accordance with manufacturers' recommendations.
- C. Exterior Storage
 - 1. Store materials and equipment above ground on blocking or skids to prevent soiling, staining, and damage.
 - 2. Cover products that are subject to damage by the elements with impervious protective sheet coverings. Provide adequate ventilation to prevent condensation.

3. Store sand, rock, or aggregate material in a well-drained area on solid surfaces to prevent mixing with foreign matter.
- D. Arrange storage to allow adequate inspection.
- E. Periodically inspect stored products to assure that products are maintained under specified conditions and are free from damage and deterioration.
- F. Protection After Installation
 1. Prevent damage to materials and equipment.
 2. Use whatever protective materials or methods are necessary to prevent damage to installed products from traffic, construction operations, and weather. Remove protection when no longer required.
 3. Maintain temperature and humidity conditions in interior spaces for the Work in accordance with manufacturers' instructions for the materials and equipment being protected.

1.4 UNDERWRITERS' LABORATORIES LABEL

- A. Materials and equipment, for which Underwriters' Laboratories, Inc. (UL) standards have been established and their label service is available, shall bear the appropriate UL Label.

1.5 MANUFACTURERS' TRADE MARKS AND NAMES

- A. University's Representative reserves the right to review and request the removal or redesign of manufacturers' trade marks and names on items of materials and equipment which will be exposed to view in the completed Work. Such removal or redesign shall be with no adjustment of the Contract Sum.

PART 2 - PRODUCTS (NOT USED)

PART 3 - EXECUTION (NOT USED)

END OF SECTION 01 60 00

SECTION 01 71 23
FIELD ENGINEERING

PART 1 - GENERAL

1.1 PREPARATION

- A. Lay out and install all Work to lines and grades in accordance with Contract Documents.

1.2 LAYOUTS AND MEASUREMENTS

- A. Contractor shall provide all survey Work required for horizontal and vertical location of all Work in this Project as applies to their scope of work.
- B. Contractor shall be responsible for paying for the replacement and reestablishment of control stakes, monuments, and lines furnished by the University that are destroyed or disturbed by Contractor's construction activities.
- C. Contractor shall furnish the University's Representative, prior to Project acceptance, 2 complete sets of the field notes for the survey Work and cut sheets in addition to 2 sets of drawings marked showing all deviations from Project alignment and grades as applies to their scope of work.

1.3 SURVEY REFERENCE POINTS

- A. Contractor shall locate and protect control points prior to beginning the Work, and preserve all permanent reference points throughout construction operations. Contractor shall:
 - 1. Not change reference points without prior approval of the University's Representative.
 - 2. Report to the University's Representative when any reference point is lost, destroyed, or requires relocation due to necessary changes in grades or locations.

1.4 PROJECT SURVEY REQUIREMENTS

- A. Contractor shall establish lines and levels, locate, and lay out for own work.
- B. Contractor shall provide layouts as Work proceeds to assure compliance with required schedules, lines, levels, and tolerances for own work.

1.5 RECORDS

- A. Contractor are required to maintain a complete and accurate log of all control and survey Work as it progresses for own work.

1.6 SUBMITTALS

- A. Upon request by the University's Representative, Contractor shall submit documentation to verify accuracy of field engineering Work.

LAZY K RESTORATION
UNIVERSITY OF CALIFORNIA MERCED
MERCED, CALIFORNIA

PROJECT NO.: **660175 1B 19900**

PART 2 - PRODUCTS (NOT USED)

PART 3 - EXECUTION (NOT USED)

END OF SECTION 01 71 23

**SECTION 01 73 35
SELECTIVE DEMOLITION**

PART 1 - GENERAL

1.1 SECTION REQUIREMENTS

- A. Extent of demolition will be shown on Drawings.
- B. No demolition shall commence until prior written approval is obtained from the University's Representative.
- C. Unless otherwise indicated, demolished materials become Contractor's property. Remove from Project site.
- D. Items indicated to be removed and salvaged remain University's property. Remove, clean, and deliver to University's designated storage area.
- E. Comply with Environmental Protection Agency (EPA) regulations and disposal regulations of authorities having jurisdiction.
- F. Prior to starting demolition of any, comply with requirements listed in Section 01 41 00 Regulatory Requirements.

PART 2 - PRODUCTS (NOT USED)

PART 3 - EXECUTION

3.1 DEMOLITION

- A. Maintain and protect existing utilities to remain in service before proceeding with demolition, providing bypass connections to other buildings on the system.
- B. Locate, identify, shut off, disconnect, and cap off utility services to be demolished.
- C. Conduct demolition operations and remove debris to prevent injury to people and damage to adjacent buildings and site improvements.
- D. Neatly cut openings and holes plumb, square, and true to dimensions required. Use cutting methods least likely to damage construction to remain or adjoining construction.
- E. Promptly patch and repair holes and damaged surfaces of building caused by demolition. Restore ex-posed finishes of patched areas and extend finish restoration into remaining adjoining construction.
- F. Promptly remove demolished materials from University's property and legally dispose of them. Do not burn demolished materials.

END OF SECTION 01 73 35

SECTION 01 77 00
CLOSEOUT PROCEDURES, FINAL CLEANING, AND EXTRA MATERIAL
AS IT APPLIES

PART 1 - GENERAL

1.1 FINAL COMPLETION

- A. When Work is complete, submit written certification to University's Representative that:
1. Work has been inspected by the General Contractor for compliance with the Contract Documents.
 2. Work has been completed in accordance with the Contract Documents.
 3. Equipment and systems have been tested in presence of the University's Representative and are operational.
 4. Work is complete and ready for final inspection.

1.2 PREPARATION FOR FINAL INSPECTION

- A. Perform final cleaning as specified below.
- B. In accordance with Section 01 78 36 Guarantees, Warranties, Bonds, Service & Maintenance Contracts, assemble guarantees/warranties with service and maintenance contracts, operating and maintenance instructions, and other items as specified, and submit to the University's Representative.

1.3 FINAL CLEANING

- A. Upon completion of the Work, the General Contractor shall promptly remove from the Project site and Project site vicinity (including roofs):
1. All of General Contractor's equipment
 2. All temporary structures
 3. All surplus material, including construction debris, lumber, etc.
 4. Remove waste, surplus materials and rubbish from Project site, including roof areas.
- B. The entire Project site shall be left in a neat and clean condition to the satisfaction of the University's Representative.
- C. The General Contractor shall execute final cleaning prior to final inspection. Cleaning shall be by experienced professional cleaners.
- D. The General Contractor shall:
1. Clean interior and exterior surfaces exposed to view; remove temporary labels, stains and foreign substances, polish glass and glossy surfaces, vacuum carpeted and soft surfaces, broom clean other interior spaces.

2. Clean equipment and fixtures to a sanitary condition, clean permanent filters and replace disposable filters of mechanical equipment operated during construction.
3. Clean ducts, blowers and coils if units were operated without filters during construction.
4. Vacuum and wipe sides of electrical panels and cabinetwork.
5. Comply with manufacturer's instructions for cleaning.
6. Clean each surface or unit to condition expected from normal, commercial building cleaning and maintenance program.
7. Clean Project site, sweep paved areas, rake clean ground surfaces.
8. Remove stains, dirt, finger marks, etc., from wall and ceiling surfaces and trim.
9. Disinfect, clean and polish all plumbing fixtures.
10. Use cleaning materials and methods that will not create hazards to health or property or cause damage to products or Work.
11. Remove temporary tapes, wrapping, coatings, paper labels, and similar items. Dust, mop, wash or wipe exposed and semi-exposed surfaces as necessary to leave work in new, clean condition.

1.4 RESTORATION OF DAMAGED WORK

- A. Restore or replace, as specified or directed by the University's Representative, materials and finishes damaged from movement of equipment or other operations by General Contractor at no additional cost to the University.
- B. Restoration shall be equal to original Work, and finishes shall match appearance of existing adjacent Work.

1.5 REMEDIAL WORK

- A. Remedial Work necessary owing to faulty workmanship or materials shall be performed by the General Contractor at no additional cost to the University.
- B. Work shall be coordinated with University's Representative and performed at such time and in such manner to cause minimal interruption and inconvenience to University's operations.

1.6 EXTRA MATERIAL

- A. In the various Sections, where additional or extra material is required to be delivered to the University, obtain from the University's Representative, to whom the material is to be delivered, a signed receipt stating the nature of the material, the quantity, and the place and date. Deliver such receipts to the University's Representative upon completion of the Work.
- B. In addition to required parts listed in other Sections of the Specification, provide any special programming software and database tools necessary to operate systems.

LAZY K RESTORATION
UNIVERSITY OF CALIFORNIA, MERCED
MERCED, CALIFORNIA

PROJECT NO.: **660175 1B 19900**

PART 2 - PRODUCTS (NOT USED)

PART 3 - EXECUTION (NOT USED)

END OF SECTION 01 77 00

November 1, 2004

Revision: 1
LF/SF:01 77 00

CLOSEOUT PROCEDURES, FINAL CLEANING, AND EXTRA
MATERIAL

01 77 00 – Page 3

SECTION 01 78 36
GUARANTEES, WARRANTIES, BONDS, SERVICE & MAINTENANCE CONTRACTS

PART 1 - GENERAL

1.1 GUARANTEES

- A. Guarantees from Subcontractors shall not limit Contractor's warranties and guarantees to the University. The Contractor shall cause warranties of Subcontractors to be made directly to the University. If such warranties are made to the Contractor, Contractor shall assign such warranties to the University prior to final payment.
- B. At a minimum, the Contractor shall warrant that all work installed under this Contract is free of defect and will remain in good working order for a period of one year for all surface improvements and five years for all underground work. If warranties specified elsewhere in these documents are for a longer period of time than that specified in this section, the longer warranties shall apply.

1.2 FORM OF GUARANTEE

- A. Submit written guarantees, in the form of Guarantee/Warranty Form (Exhibit 16) in accordance with Section 01 33 23 Shop Drawings, Product Data and Samples.

1.3 SUBMITTAL REQUIREMENTS

- A. Assemble required guarantees, bonds, and service and maintenance contracts.
- B. Number: 1 signed original and 2 copies.
- C. Table of Contents: Neatly typed and in orderly sequence. Provide complete information for each item as follows:
 - 1. Product or Work item.
 - 2. Firm name, address, telephone number and name of principal.
 - 3. Scope.
 - 4. Identifying name, serial number or part number.
 - 5. Proper procedure in case of failure.
 - 6. Circumstances that might affect the validity of guarantee or bond.

1.4 FORM OF SUBMITTAL

- A. Prepare in duplicate packets.
- B. Format
 - 1. On sheets 8-1/2 by 11 inches punched for 3-ring binder. Fold larger sheets to fit into binders.
 - 2. Identify each packet on the cover with typed or printed title, "Guarantees and Bonds", and the following:
 - a. Project No.

- b. Title of Project.
 - c. Name of Contractor.
- C. Binders: Commercial quality, 3-ring, with durable and cleanable plastic covers.
- D. Time of Submittals
- 1. Within 10 days after date of Substantial Completion, prior to request for final payment.
 - 2. For Work activities, where Final Completion is delayed beyond the date of Substantial Completion, provide updated submittal within 10 calendar days after Final Completion, listing the date of Final Completion as the start of the Guarantee To Repair Period.

1.5 SUBMITTALS REQUIRED

- A. Submit guarantees, bonds, and service and maintenance contracts specified in the individual Specification Sections.
- B. Compile all warranties from the specified individual Specification Sections. Submit those in a commercial, 3-ring binder with durable and cleanable plastic covers.

1.6 SPARE PARTS AND MAINTENANCE MATERIAL

- A. Provide products, spare parts, maintenance and extra materials in quantities specified in individual Specification Sections.
- B. Deliver to Project site and place in location as directed by the University's Representative and obtain receipt prior to final payment.

PART 2 - PRODUCTS (NOT USED)

PART 3 - EXECUTION (NOT USED)

END OF SECTION 01 78 36

SECTION 01 78 39
PROJECT AS-BUILT DOCUMENTS
AS IT APPLIES

PART 1 - GENERAL

1.1 MAINTENANCE OF DOCUMENTS AND SAMPLES

- A. Store Project as-built documents and samples in the Contractor's office in a location completely separate from documents used for construction. The location shall be approved by the University's Representative.
- B. Maintain as-built documents in order and in a clean, dry, legible condition.
- C. Do not use as-built documents for construction.

1.2 AS-BUILT DOCUMENTS

- A. As-built Drawings
 - 1. The Contractor shall maintain on the Project site at all times in a clean, dry legible condition, 1 set of all Drawings and 1 set of all Shop Drawings. These Drawings shall be used to record as-built conditions on a day-to-day basis, and shall be kept current, and shall be available for inspection by the University's Representative during normal working hours.
 - 2. The Contractor shall obtain weekly written confirmation from the University's Representative that the as-built conditions are adequately represented in the As-built Drawings.
 - 3. ~~On three (3) occasions to be determined by the University's Representative, the Contractor shall prepare in both AUTOCAD® format (latest version available at date of bid) and PDF Format on CD-ROM digital images of the current As-built Drawings. The image files shall be in format ORIGINAL.DWG and DRAWING NUMBER.PDF. The Contractor may scan the As-built Drawings or use a digital camera or any other appropriate means so long as the resulting image is legible when viewed from the CD-ROM using a computer. All cross references within the same AUTOCAD® drawing must be bound.~~
 - 4. Record the following types of information on As-built Drawings
 - a. Location of Work buried under or outside the building, such as plumbing and electrical lines and conduits. Provide horizontal and vertical dimensions from fixed points. Record all locations of underground Work, points of connection, valves, manholes, catch basins, capped stub outs, invert elevations, etc.
 - b. ~~Locations of all significant Work concealed inside the building, the locations of which were changed by the Contractor from those shown on the Drawings.~~
 - c. Locations of all items, not necessarily concealed but varying from the locations shown on the Drawings.
 - d. All changes in size, location, and other features of installation not shown on Drawings.
 - e. ~~Sufficient information such that Work concealed in the building may be located with reasonable ease and accuracy. This may be accomplished~~

~~by dimension or by stating the relationship to the spaces in the building near which the Work was installed. The University's Representative's decision on what constitutes sufficient information shall be final.~~

- f. ~~All electrical and control installations to indicate terminal points, wire numbers/circuit numbers, panel designations, device identification, and/or sequence of operations.~~
 - g. Record existing below-grade utilities if they are exposed by the project or are located within the Project boundary on the as-built drawings.
 - h. Provide dimension from a designated reference point for all below-grade utilities, provide and record on the as-built drawing the exact dimension from an existing designated reference point relative to the campus bench mark elevation.
5. Additional drawings shall be provided as required to properly describe changes.
 6. Upon completion of the Work, the As-built Drawings shall be certified by the Contractor to represent the true, as-built conditions and shall be given to the University's Representative as described in Subsection 1.3.

B. Specifications and Addenda

- ~~1. Record the following:~~
 - ~~a. Manufacturer, trade name, catalog number, and supplier of each product and item of equipment actually installed.~~
 - ~~b. Changes made by Addenda, Change Order (Exhibit 9), or Field Order (Exhibit 8), and clarifications and interpretations made by Letter of Instruction (Exhibit 26).~~
 - ~~c. Provide two (2) hard copies of the specifications and addenda ten (10) days after Final Completion.~~

C. Large-Scale Layout Drawings

- ~~1. Division 22 Plumbing, Division 23 Heating, m Ventilating, and Air Conditioning (HVAC) and Division 26 Electrical of the Specifications require the preparation of large scale, detailed Layout Drawings of the Work of those Divisions. These Layout Drawings are not Shop Drawings as defined by the General Conditions, but, together with Shop Drawings or Layout Drawings of all other affected Sections, are used to check, coordinate, and integrate the Work of the various Sections.~~

D. Project Photographs

- ~~1.~~ At appropriate intervals but not less than once a month, the Contractor shall submit digital site photographs on CD-ROM to the University's Representative. These photographs shall:
 - ~~a. Use format NAME.JPG~~
 - ~~b. Show the completed installation of all pipes, ducts, cable trays and other mechanical, electrical and plumbing services before they are covered and hidden from view. This shall include, but not be limited to, services cast into concrete elements; buried services covered by ground slabs; services in walls hidden by sheetrock, tile, or plaster; services above ceilings.~~

2. The CD-ROM containing the photographs shall also contain an electronic file with enough information to identify the exact location of the element shown in each photograph. The electronic file shall:
 - a. Be in Microsoft Word or Excel format.
 - b. Cross reference to the name of each photograph.
 - c. Identify the location and direction of each photograph. As a minimum, this shall include element identification, grid reference, floor number if applicable and cardinal direction photographer was facing when photograph was taken.
 - d. Identify the date of the photograph.

1.3 PROJECT LEGACY DOCUMENTS

A. AS-BUILT DRAWINGS

1. The Contractor shall submit to the University's Representative, 10 calendar days after Final Completion, fully updated As-built Drawings and Shop Drawings. These Drawings shall be prepared from the As-built Drawings.
2. The As-Built Drawings shall be in electronic format, AUTOCAD® latest version available at date of bid. File shall be ORIGINAL.DWG format and PDF format. Electronic media shall be CD-ROM. The General Contractor shall provide two (2) hard copies of the drawings on 24 pound 96 Bright Bond paper or better quality and two (2) copies on CD-ROMs. Each CD-ROM shall contain all of the electronic Drawing files.
3. The Contractor's AUTOCAD® As-Built Drawings may be based on AUTOCAD® Design Drawings provided by the University or the University's Design Professional so long as for each drawing:
 - a. Any lines added to the Design Drawing in model space by the Contractor shall be in AUTOCAD® layers not currently used by the Design Drawings. The Contractor shall not use more than five (5) layers for added lines.
 - b. Any lines deleted from the Design Drawing in model space by the Contractor shall be copied into a single layer not currently used by the Design Drawings.
 - c. The Contractor's As-Built Drawings based on the Design Drawings shall therefore contain:
 - (1) The lines on the Design Drawings in the same AUTOCAD® layers as the Design Drawings (not changed by the Contractor).
 - (2) A single AUTOCAD® layer containing the lines on Design Drawings deleted by the Contractor.
 - (3) Not more than five (5) AUTOCAD® layers containing the lines added by the Contractor to the Design Drawing.
4. AUTOCAD® As-Built Drawings not based on AUTOCAD® Design Drawings provided by the University or the University's Design Professional, shall be configured as follows:
 - a. Title block and plot set-up shall be in Paper space.
 - b. All other drawing data shall be in Model space.
 - c. Each drawing shall contain a title block and orientation/north arrow approved by the University's Representative.

~~B. SHOP DRAWINGS~~

- ~~1. The Contractor shall submit to the University's Representative, 10 calendar days after Final Completion, fully updated Shop Drawings.
Contractor shall:
 - ~~a. Provide 2 hard copies of the Shop Drawings on 24 pound, 96 Bright Bond paper.~~
 - ~~b. Provide 2 CD-ROMs, each of which contains all drawing data if the Contractor used Computer Aided Drafting software to prepare the Shop Drawings.~~~~

PART 2 - PRODUCTS (NOT USED)

PART 3 - EXECUTION (NOT USED)

END OF SECTION 01 78 39